

THIS DOCUMENT IS SUBJECT TO CHANGE WITHOUT NOTICE. IT IS CONFIDENTIAL AND A PROPERTY OF Amphenol LTW. DISCLOSURE TO THIRD PARTY HAS TO BE AUTHORIZED BY Amphenol LTW.

REV.	ECN NO.	DATE	SIGN	DESCRIPTION
B	E191899	2019/11/19	Ruru	$\triangle B$ X4

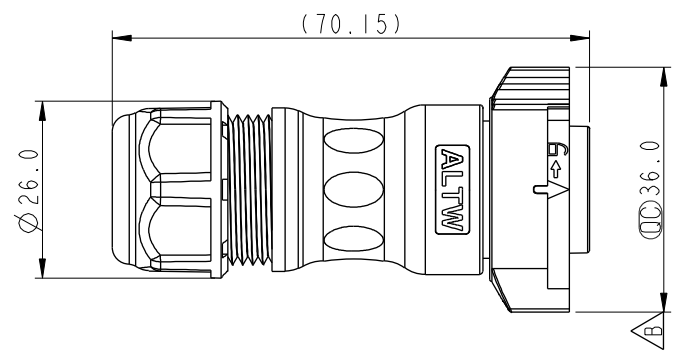
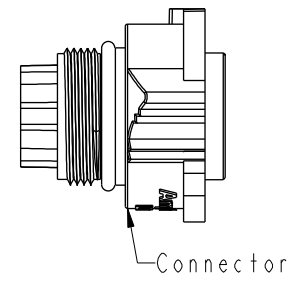
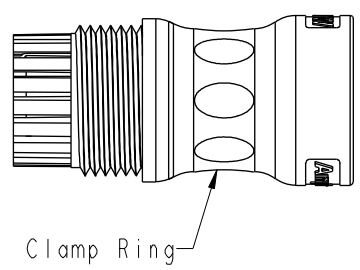
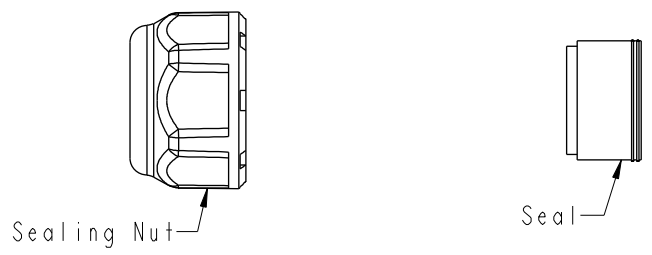

DD-XXBFMA-QL8XN0

12-12 Pin

14-14 Pin

18-18 Pin

S: With Red Color Seal 1, Cable OD 6.0~8.0mm.
M: With Yellow Color Seal 2, Cable OD 8.0~10.0mm.
L: With Blue Color Seal 3, Cable OD 10.0~12.0mm.
A: With Seal 1 & Seal 2 & Seal 3.

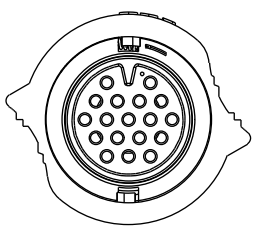
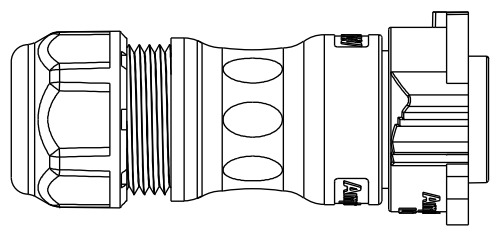

$\triangle B$ Note:

- * ϕ Important Dimension
- * Waterproof Rate: IP68, Mated
IP68 : 1M Depth Of Water In 24hours
- * Housing: Thermoplastic, Black
- * Clamp Ring: Thermoplastic, Black
- * Sealing Nut: Thermoplastic, Black
- * Seals: Rubber

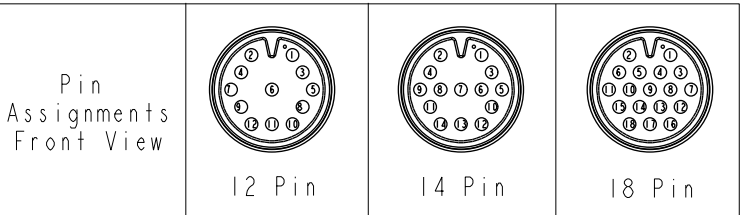

UNIT:mm TOLERANCE ± 0.5 mm		TITLE XLOK, D-5A, CABLE W/O SR F, M, FI CRIMP, XLOK $\triangle B$	<h1>Amphenol LTW</h1> <p>安費諾亮泰企業股份有限公司</p>		ITEM NO ALTW	DRAWN BY Ruru	DATE 2019-11-19	
		SCALE 1:1	SIZE A4	SHEET 1	OF 1	DWG NO DD-XXBFMA-QL8XN0 $\triangle B$	CHECKED BY Rita	DATE 2019-11-19
		REV. B	WC-REV. .0	ϕ Inspection item		CUSTOMER	APPROVED BY Max	DATE 2019-11-19