



GRF2043

Linear Gain Block with Bypass 0.15 to 6 GHz

FEATURES

- Flexible Bias Voltage and Current
- Single Control Logic Input
- Internally Matched to 50 Ω
- Compact 1.5 x 1.5 mm DFN-6 Package
- Process: GaAs pHEMT

Reference: 5 V / 80 mA / 1.9 GHz

- Gain: 18.5 dB
- OP1dB: 22 dBm
- OIP3: 36 dBm
- Evaluation Board Noise Figure: 1.8 dB
- Bypass Mode Gain: -1.5 dB
- Bypass Mode OP1dB: 23 dBm
- Bypass Mode OIP3: 45 dBm

APPLICATIONS

- Cellular Infrastructure
- VHF/UHF and ISM Radios
- Cellular Repeaters and Signal Boosters

DESCRIPTION

The GRF2043 is a broadband gain block with bypass for small cell, wireless infrastructure, and other high-performance applications. It exhibits flat gain, outstanding noise figure (NF), and linearity from 400 to 2700 MHz with a single match.

The device can be operated from a supply voltage of 2.7 to 6 volts with a selectable I_{DDQ} range from 20 to 100 mA for optimal efficiency and linearity.

The GRF2043 is internally matched to 50 Ω at the input and output ports requiring only external DC blocks and a bias choke on the output.

Please consult with the GRF applications engineering team for custom tuning/evaluation board data and device S-parameters.

Additional tunes can be found on the GRF2043 "Custom Tunes" product page: [GRF2043 Custom Tunes](#)

BLOCK DIAGRAM

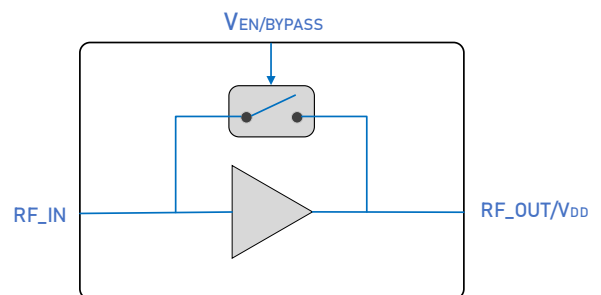

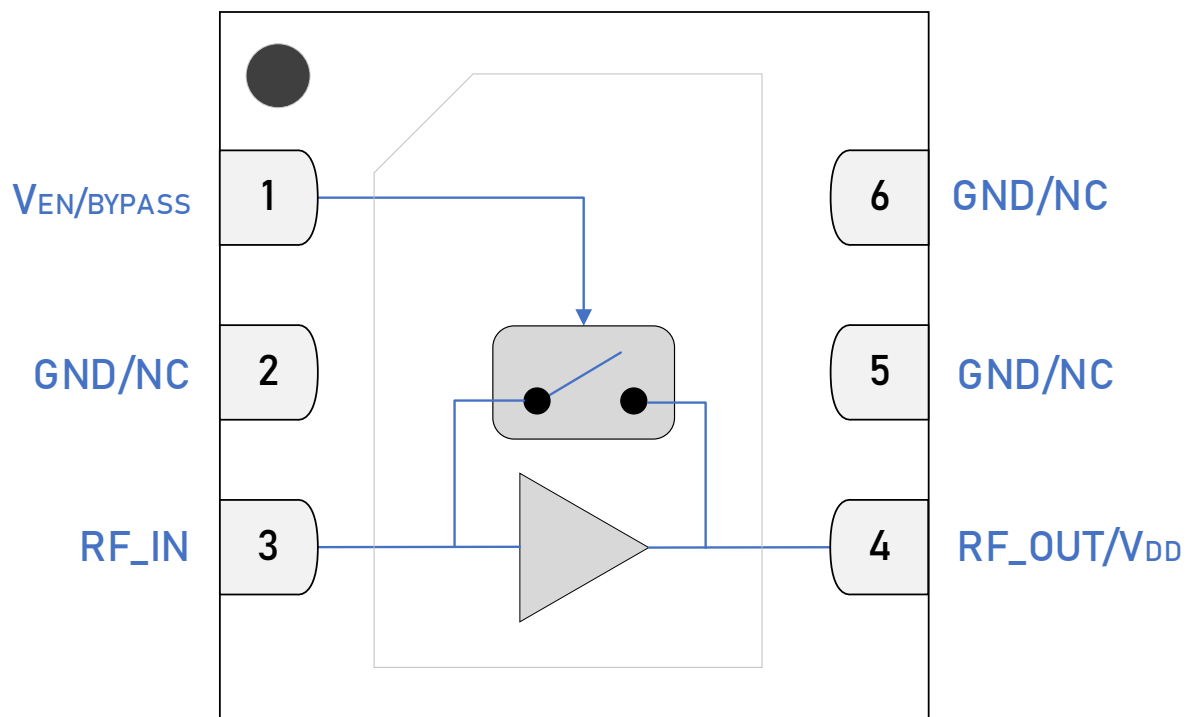

DFN-6 1.5 x 1.5 mm Pin Out (Top View)

Pin Assignments

Pin	Name	Description	Note
1	V _{ENABLE/BYPASS}	V _{EN/BYPASS} Voltage Input	V _{EN/BYPASS} ≤ 0.2 volts sets Bypass mode. V _{EN/BYPASS} and external series resistor control the device I _{DDQ} when V _{EN/BYPASS} is high.
2, 5, 6	GND/NC	Ground or No Connect	No internal connection to die. These pins can be left unconnected or connected to ground (highly recommended). Use a via as close to the pin as possible if grounded.
3	RF_IN	RF Input	Internally matched to 50 Ω. An external DC blocking capacitor must be used.
4	RF_OUT/V _{DD}	RF Output	Internally matched to 50 Ω. V _{DD} must be applied to this pin through an RF choke.
PKG BASE	GND	Ground	Provides DC and RF ground for device, as well as thermal heat sink. Recommend multiple 8-mil vias beneath the package for optimal RF and thermal performance. Refer to evaluation board top layer graphic on schematic page.

Control Logic Truth Table

Mode	Description	V _{DD}	V _{EN/BYPASS}
High Gain	High Gain	1	1
Bypass	Linear Bypass Mode	1	0
Logic Level "0"	Logic Low	0 V to 0.2 V	0 V to 0.2 V
Logic Level "1"	Logic High	1.8 V to 5 V	1.5 V to V _{DD}

Absolute Ratings

Parameter	Symbol	Min.	Max.	Unit
Supply Voltage	V_{DD}	0	6	V
RF Input Power (Gain Mode): Load VSWR < 2:1, $V_{DD} = 5$ V, $V_{EN/BYPASS} = 5$ V.	$P_{IN\ MAX}$		27	dBm
RF Input Power (Bypass Mode): Load VSWR < 2:1, $V_{DD} = 5$ V, $V_{EN/BYPASS} = 0$ V.	$P_{IN\ MAX}$		27	dBm
Operating Temperature (package base).	$T_{PKG\ BASE}$	-40	105	°C
Maximum Channel Temperature (MTTF > 10 ⁶ hours).	T_{MAX}		170	°C
Maximum Dissipated Power	$P_{DISS\ MAX}$		600	mW

Electrostatic Discharge

Human Body Model	HBM	250		V
------------------	-----	-----	--	---

Storage

Storage Temperature	T_{STG}	-65	150	°C
Moisture Sensitivity Level	MSL		1	--



Caution! ESD Sensitive Device.

Exceeding Absolute Maximum Rating conditions may cause permanent damage.

Note: For additional information, please refer to [Package Manufacturing Information | Guerrilla RF \(guerrilla-rf.com\)](#)



All Guerrilla RF products are provided in RoHS compliant lead (Pb)-free packaging requiring no exemptions. Additional information for this topic can be found at this link - [Environmental and Restricted Substance Statement Library](#)

Recommended Operating Conditions

Parameter	Symbol	Specification			Unit	Condition
		Min.	Typ.	Max.		
Supply Voltage	V _{DD}	2.7	5	6	V	
RF Frequency Range	F _{RF}	0.15	1.9	6	GHz	Typical application schematic with external matching components (notes 1 & 2).
Operating Temperature (package base)	T _{PKG BASE}	-40		105	°C	
RF_IN Port Impedance	Z _{RF_IN}		50		Ω	Single-ended.
RF_OUT Port Impedance	Z _{RF_OUT}		50		Ω	Single-ended.

Note 1: Operation outside of this range is supported by using different custom tunes. Examples of other optimized tunes can be found here: [GRF2043 Custom Tunes](#)

Note 2: Contact the Guerrilla RF applications team for guidance on optimizing the tuning of the device for alternative bands.

Nominal Operating Parameters – General

The following conditions apply unless noted otherwise: typical application schematic using the 0.4 to 2.7 GHz tuning set, $V_{DD} = 5\text{ V}$, $V_{EN/BYPASS} = 5\text{ V}$, $I_{DDQ} = 80\text{ mA}$, $F_{TEST} = 1.9\text{ GHz}$, $50\ \Omega$ system impedance. $T_{PKG\ BASE} = 25\text{ }^\circ\text{C}$. Evaluation board losses are included within the specifications.

Parameter	Symbol	Specification			Unit	Condition
		Min.	Typ.	Max.		
Supply Current	I_{DDQ}		80		mA	$V_{DD} = 5\text{ V}$, $V_{EN/BYPASS} = 5\text{ V}$.
Enable Current	I_{ENABLE}		5		mA	$V_{DD} = 5\text{ V}$, $V_{EN/BYPASS} = 5\text{ V}$.
Switching Rise Time	T_{RISE}		200		ns	Bypass mode to Gain mode. Pin = 5.2 dBm (note 3) .
Switching Fall Time	T_{FALL}		50		ns	Gain mode to Bypass mode. Pin = 5.3 dBm (note 4) .

Disabled Mode

Leakage Current	$I_{LEAKAGE}$		500		μA	$V_{DD} = 5\text{ V}$, $V_{EN/BYPASS} = 0\text{ V}$.
-----------------	---------------	--	-----	--	---------------	--

Thermal Data

Thermal Resistance (Infrared Scan)	Θ_{JC}		80		$^\circ\text{C}/\text{W}$	On standard evaluation board (note 5) .
------------------------------------	---------------	--	----	--	---------------------------	--

Note 3: Switching Time: 50% of $V_{EN/BYPASS}$ to 90% of P_{out} .

Note 4: Switching Time: 50% of $V_{EN/BYPASS}$ to 10% of P_{out} .

Note 5: MTTF > 10^6 hours for $T_{CHANNEL} \leq 170\text{ }^\circ\text{C}$.

Nominal Operating Parameters – RF

The following conditions apply unless noted otherwise: typical application schematic using the 0.4 to 2.7 GHz tuning set, $V_{DD} = 5\text{ V}$, $V_{EN/BYPASS} = 5\text{ V}$, $I_{DDQ} = 80\text{ mA}$, $F_{TEST} = 1.9\text{ GHz}$, $50\ \Omega$ system impedance. $T_{PKG\ BASE} = 25\text{ }^\circ\text{C}$. Evaluation board losses are included within the specifications.

Gain Mode

Parameter	Symbol	Specification			Unit	Condition
		Min.	Typ.	Max.		
Gain	S21	16.8	18.5		dB	$V_{DD} = 5\text{ V}$, $V_{EN/BYPASS} = 5\text{ V}$.
Output 1 dB Compression Power	OP1dB	20.4	22		dBm	
Output 3rd Order Intercept Point	OIP3		36		dBm	2 dBm P_{OUT} per tone at 2 MHz spacing (1899 and 1901 MHz).
Noise Figure	NF		1.8		dB	On standard evaluation board.

Bypass Mode

Gain	S21	-3.4	-1.5		dB	$V_{DD} = 5\text{ V}$, $V_{EN/BYPASS} = 5\text{ V}$.
Output 1 dB Compression Power	OP1dB		23		dBm	
Output 3rd Order Intercept Point	OIP3		45		dBm	8 dBm P_{OUT} per tone at 2 MHz spacing (1899 and 1901 MHz).

GRF2043 Typical Operating Curves: 0.4 to 2.7 GHz Tune

Gain Mode

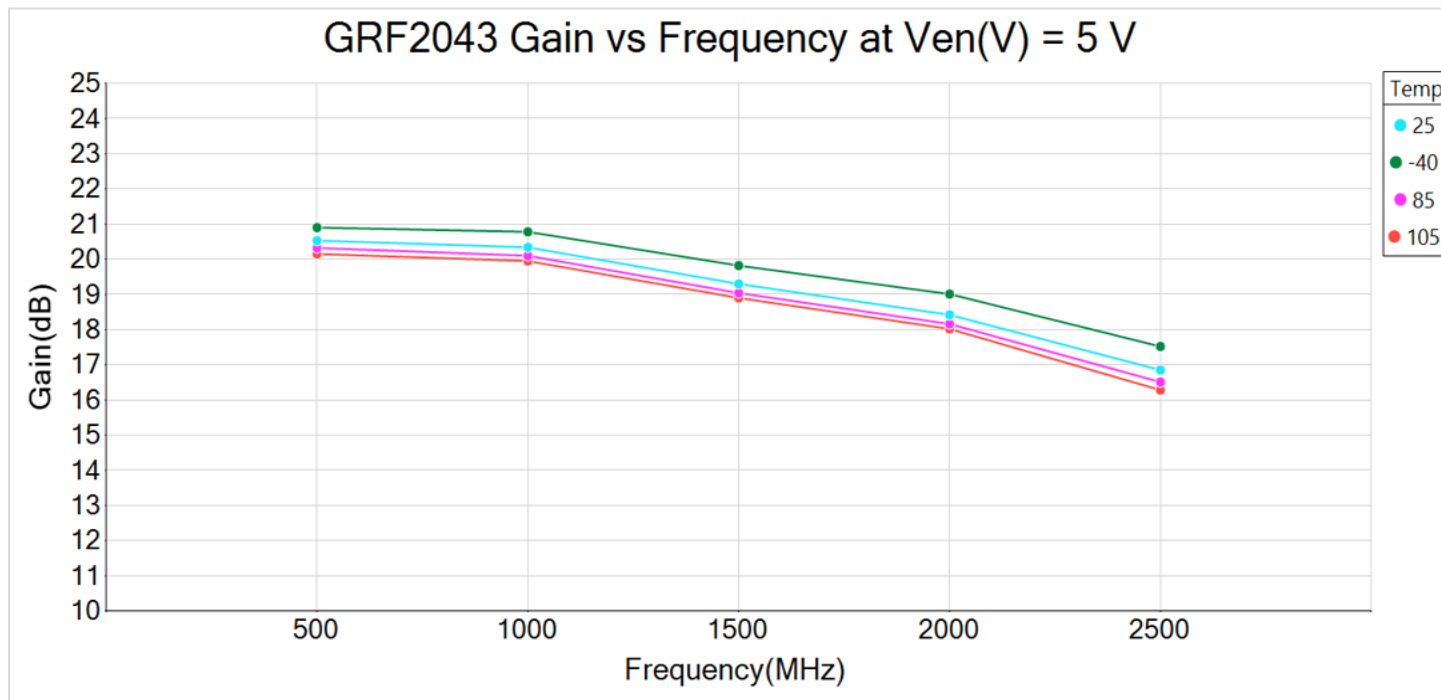

Bypass Mode

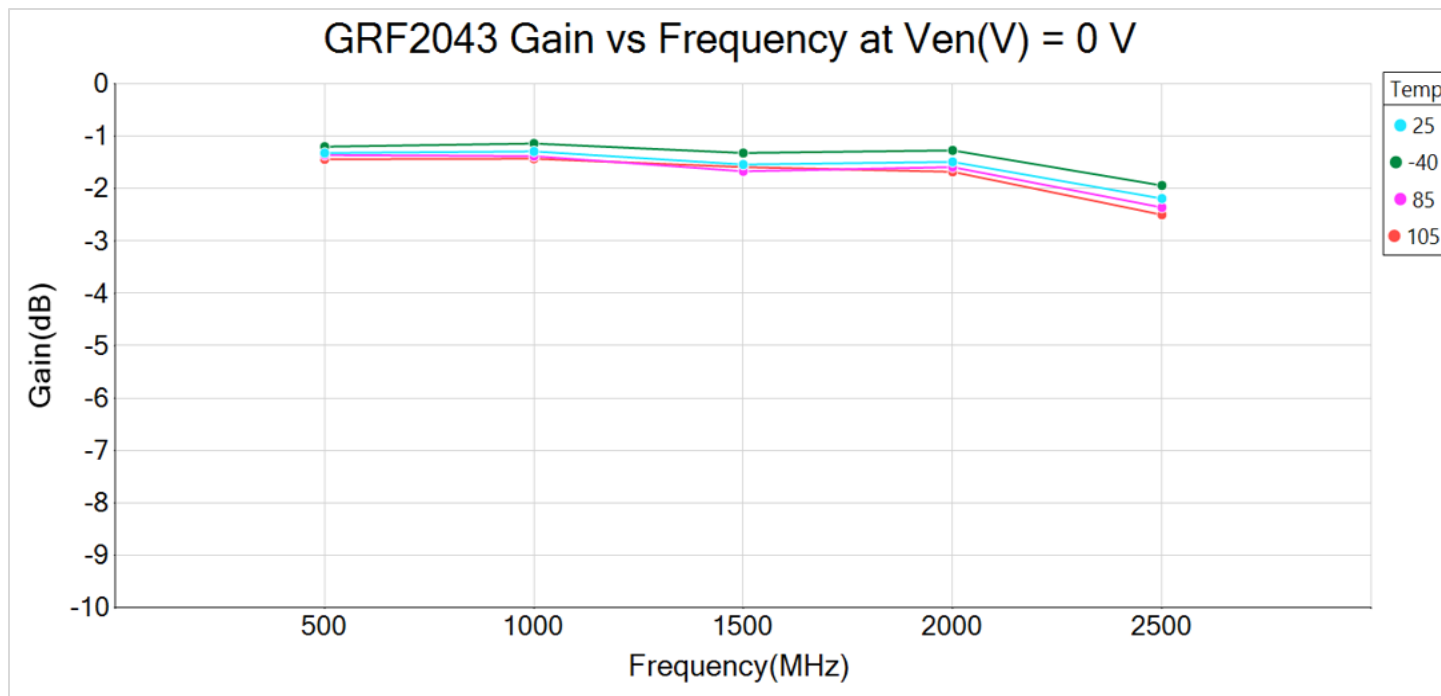

GRF2043 Typical Operating Curves: 0.4 to 2.7 GHz Tune

Gain Mode

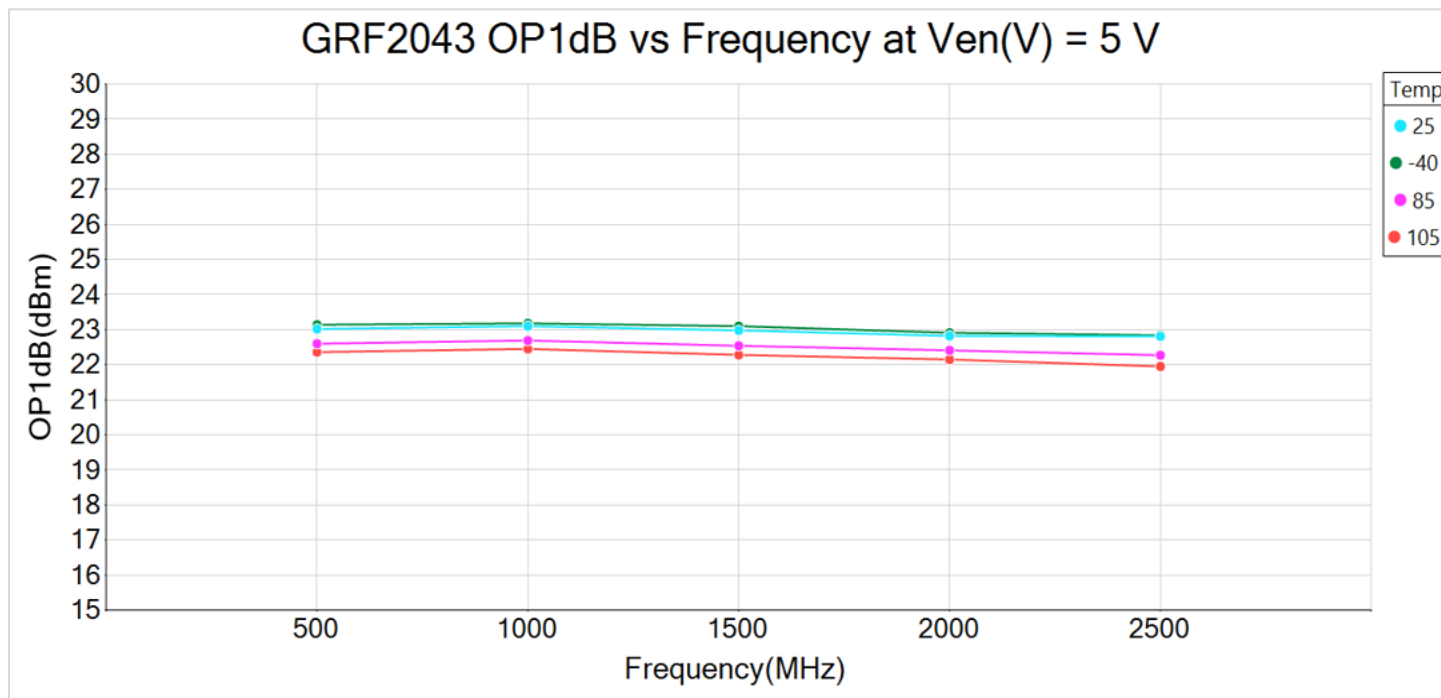

Bypass Mode

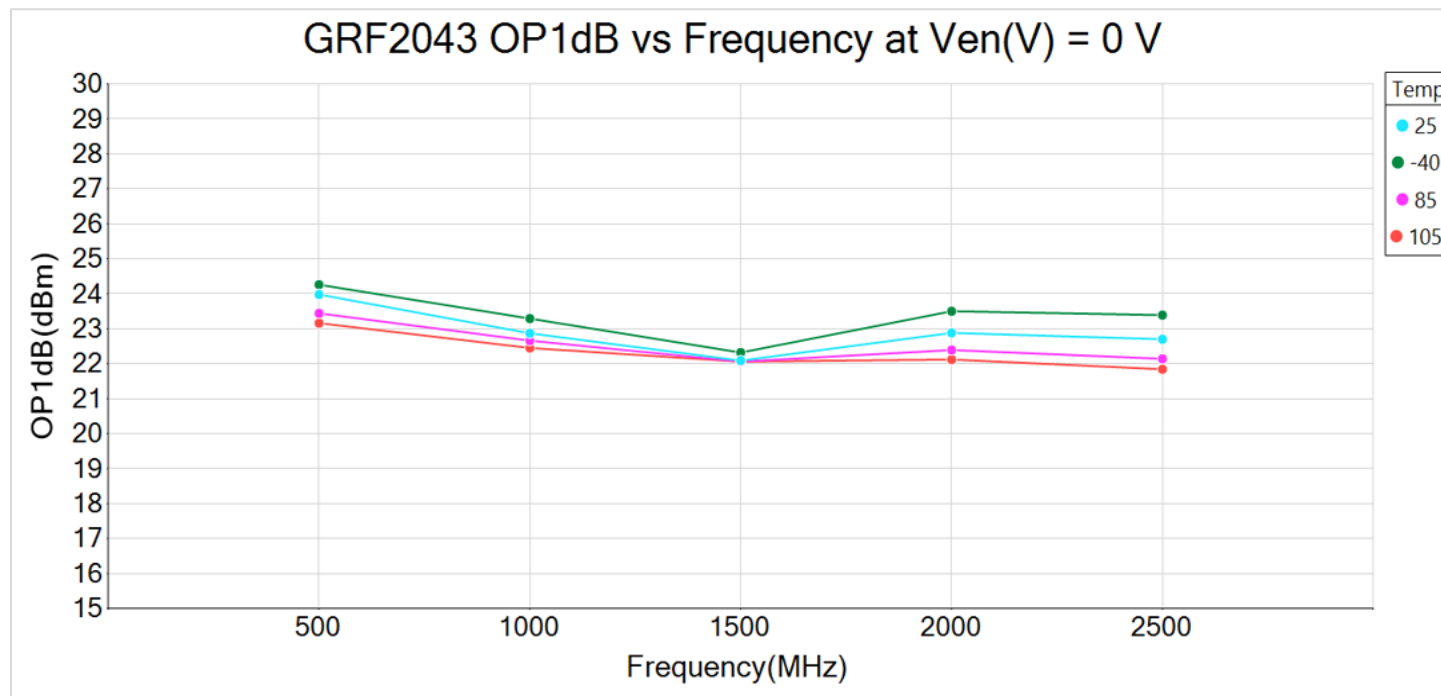

GRF2043 Typical Operating Curves: 0.4 to 2.7 GHz Tune

Gain Mode

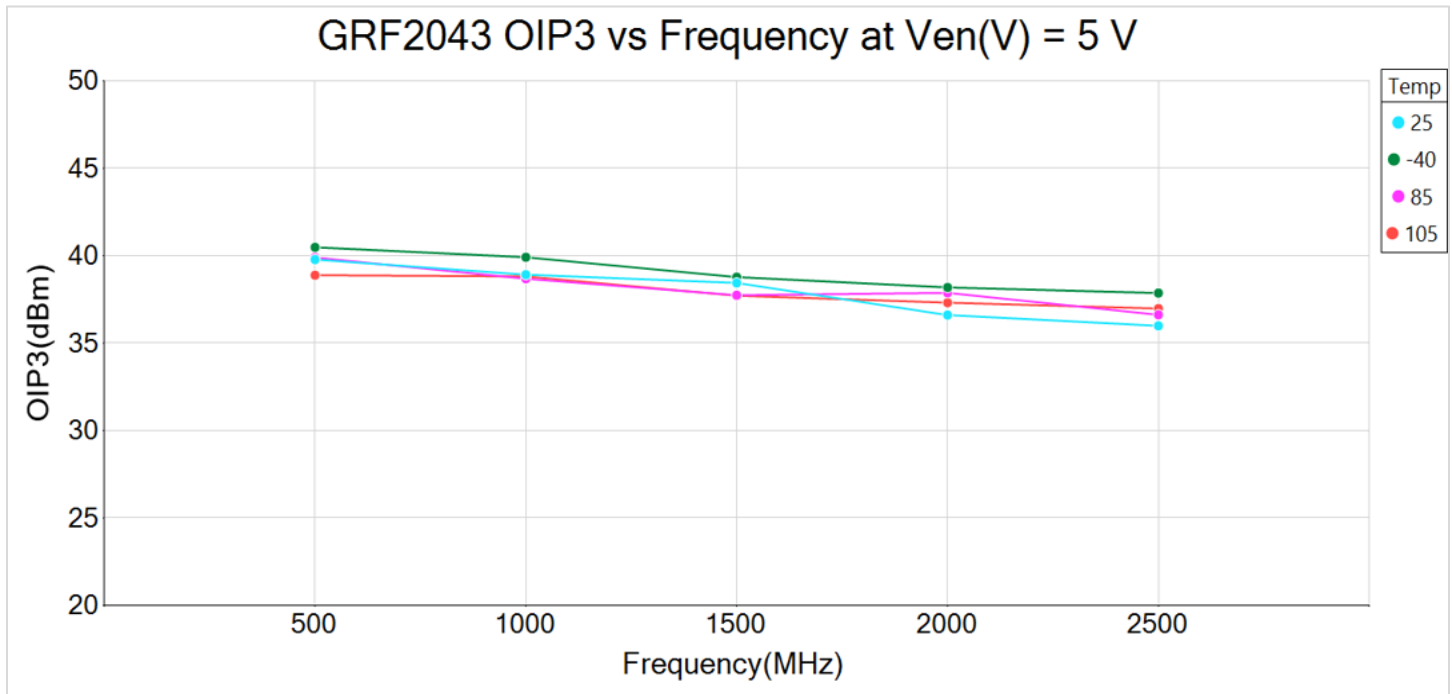

Bypass Mode

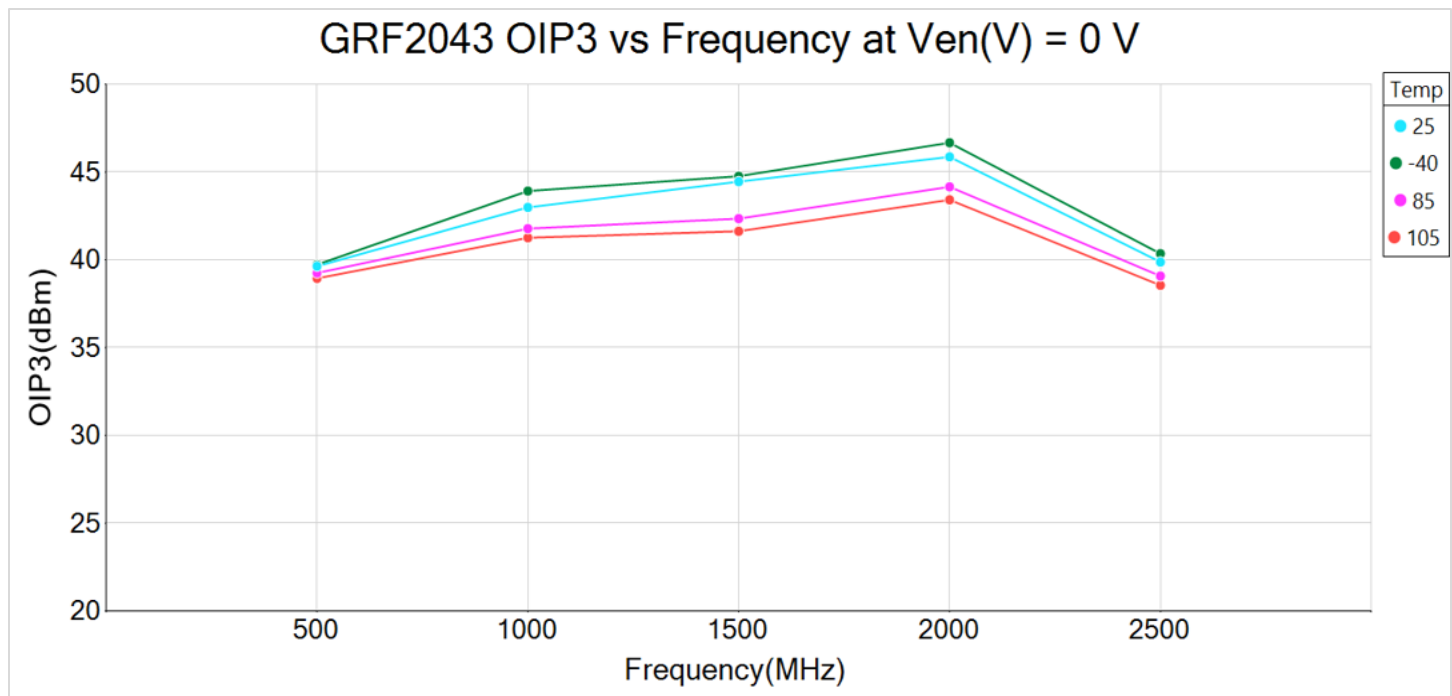

GRF2043 Typical Operating Curves: 0.4 to 2.7 GHz Tune

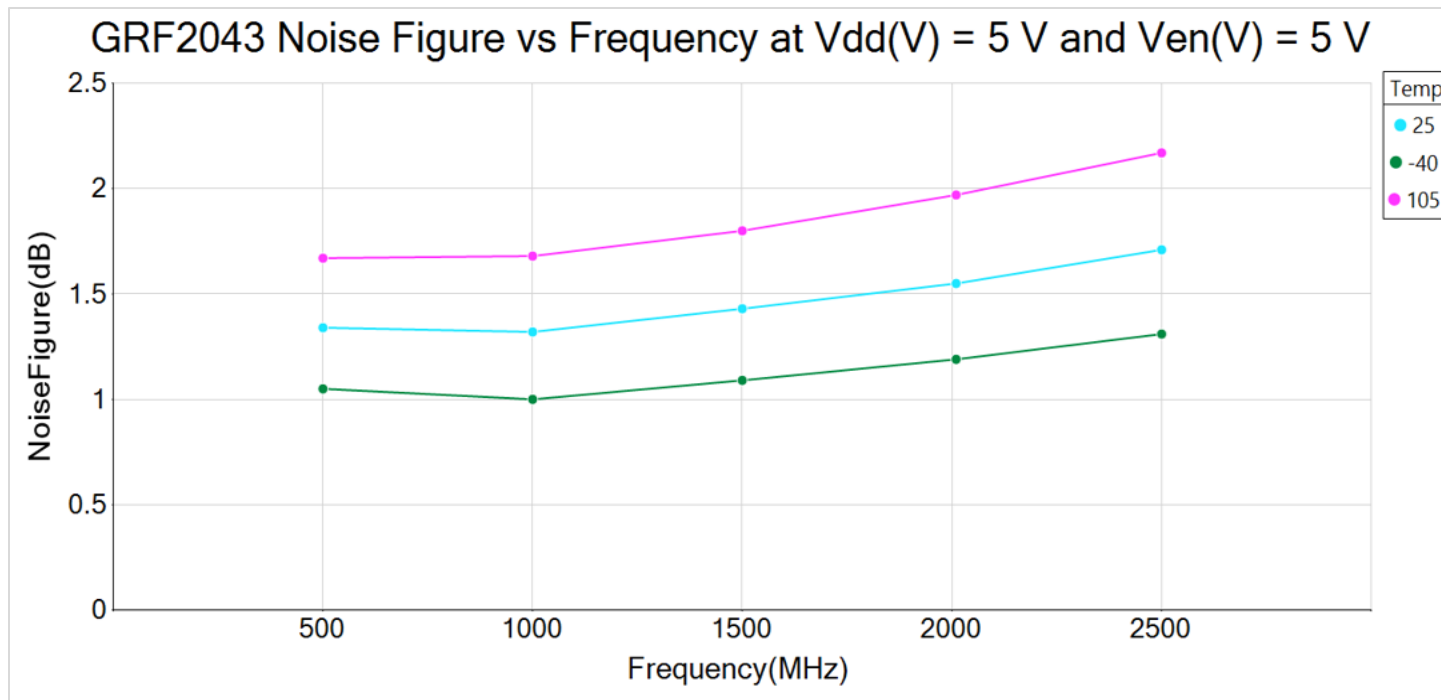

GRF2043 Typical Operating Curves: S-Parameters (Gain Mode, 0.4 to 2.7 GHz Tune)

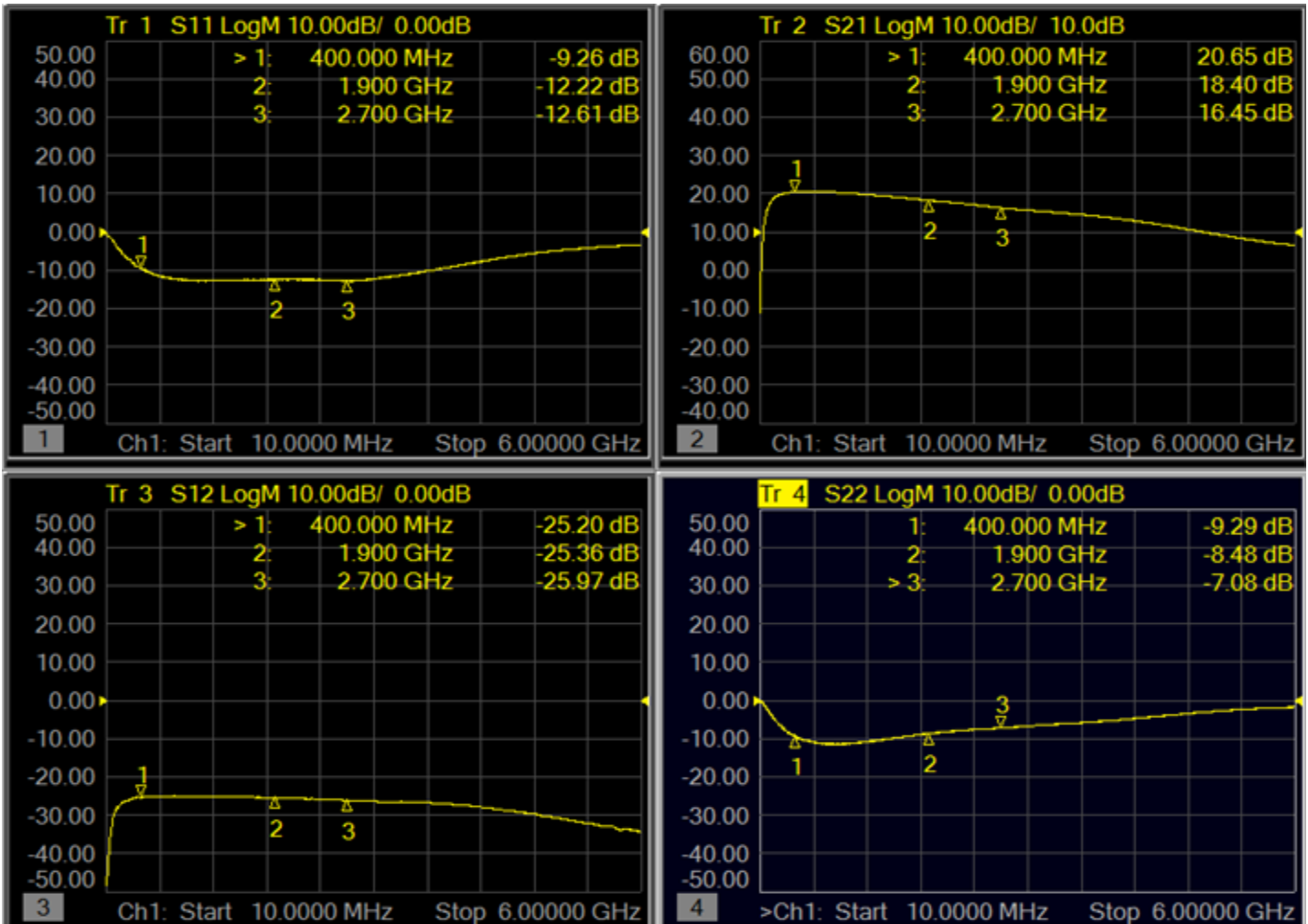

GRF2043 Typical Operating Curves: S-Parameters (Bypass Mode, 0.4 to 2.7 GHz Tune)

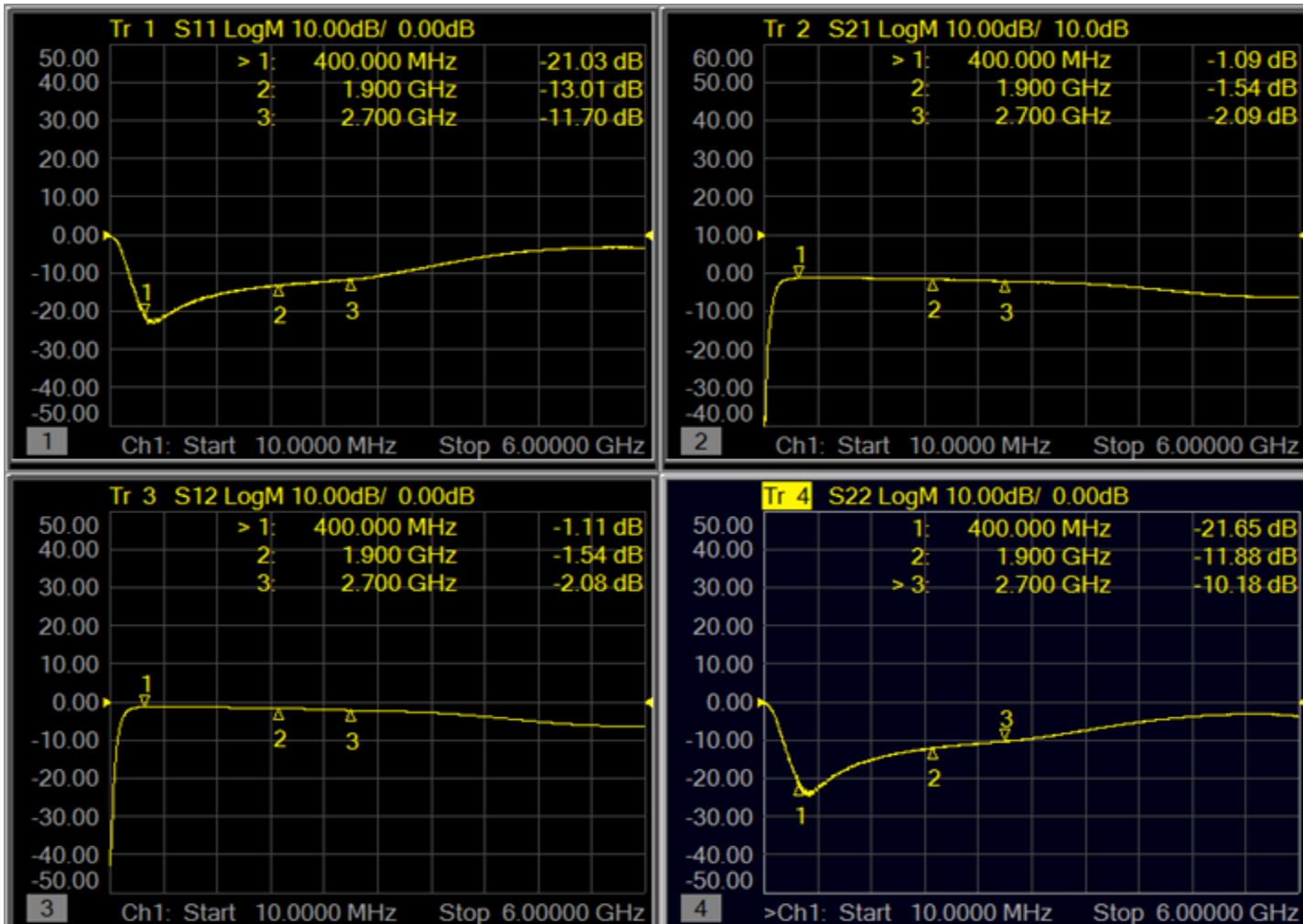

GRF2043 Typical Operating Curves: Stability Mu Factor (10 MHz to 20 GHz)

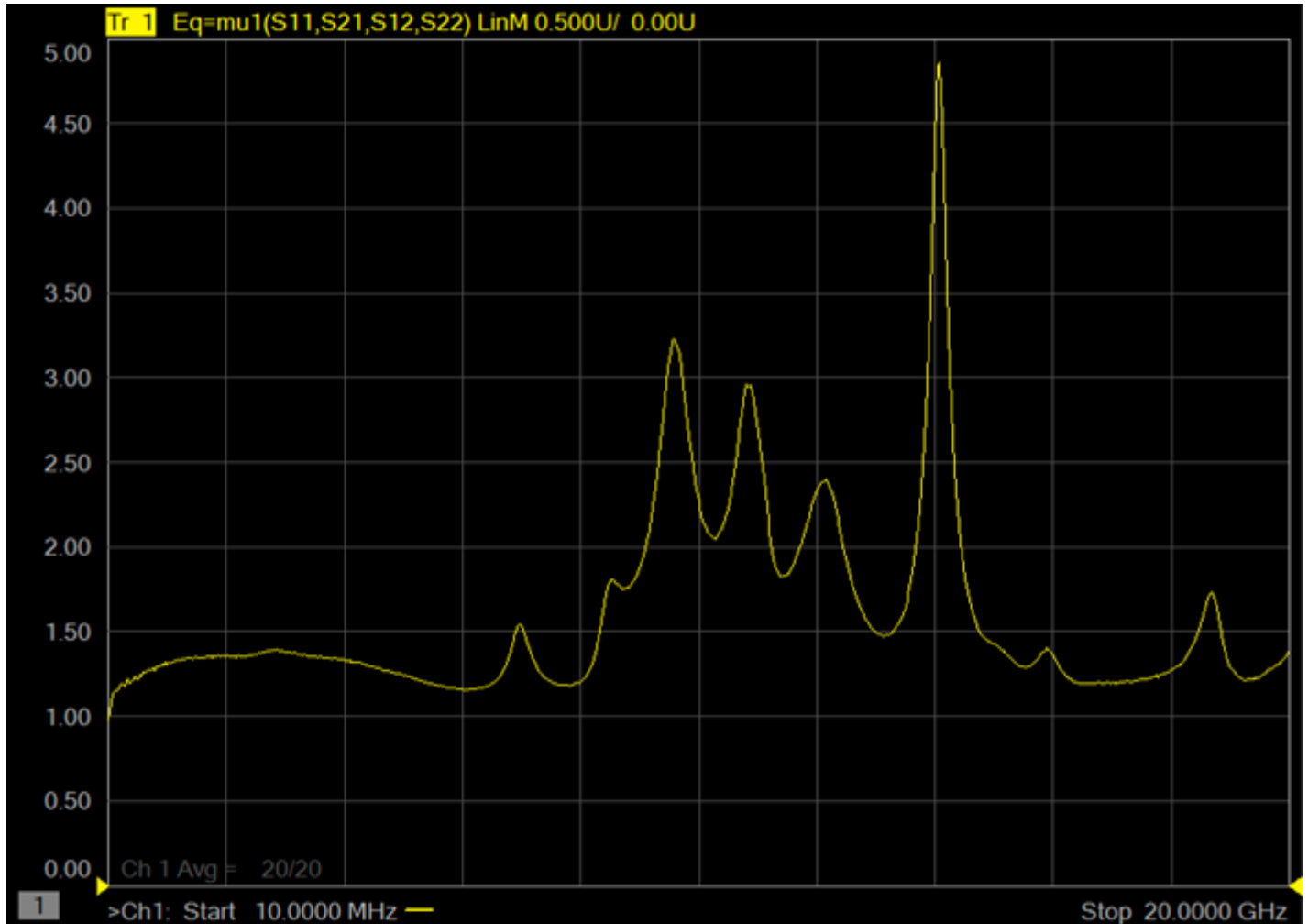

Note: Mu factor ≥ 1.0 implies unconditional stability.

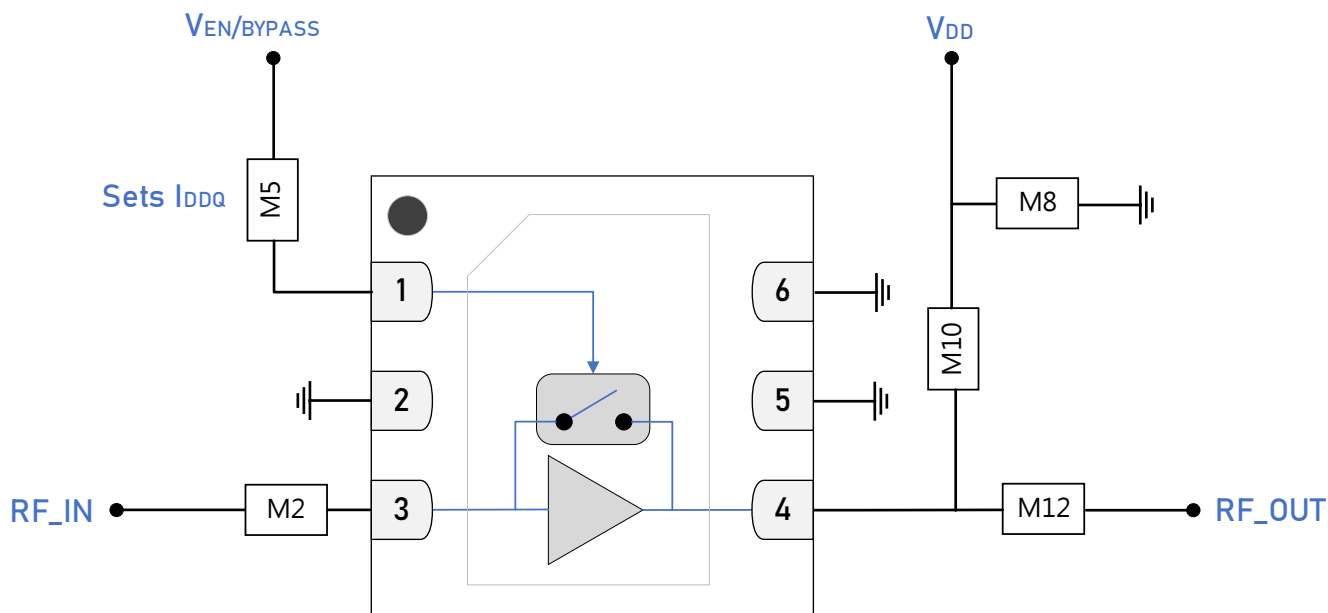

GRF2043 Standard Evaluation Board Schematic

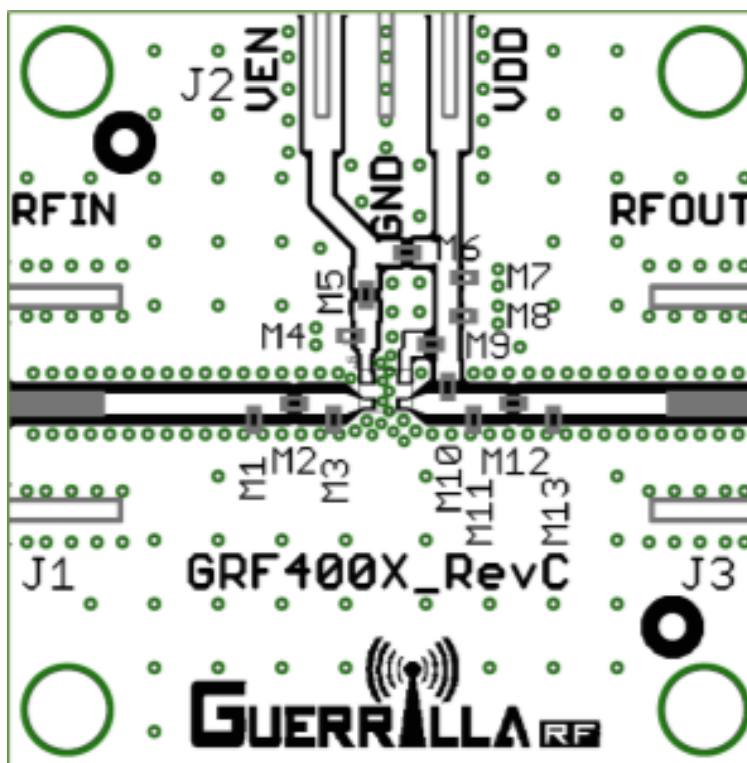

GRF2043 Evaluation Board Assembly Diagram

GRF2043 Evaluation Board Assembly Diagram Reference: 0.4 to 2.7 GHz Tune

Component	Type	Manufacturer	Family	Value	Package Size	Substitution
M1, M3, M4, M6, M7, M9, M11, M13	DNP	--	--	--	--	--
M2	Capacitor	Murata	GJM	100 pF	0402	ok
M5 (sets I _{DDQ})	Resistor	Various	5%	See Curves	0402	ok
M8	Capacitor	Murata	GRM	0.1 μF	0402	ok
M10	Inductor	Murata	LQG	33 nH	0402	ok
M12	Capacitor	Murata	GRM	100 pF	0402	ok
Evaluation Board	GRF400X_RevC					

GRF2043 Bias Resistor Selection Curves:

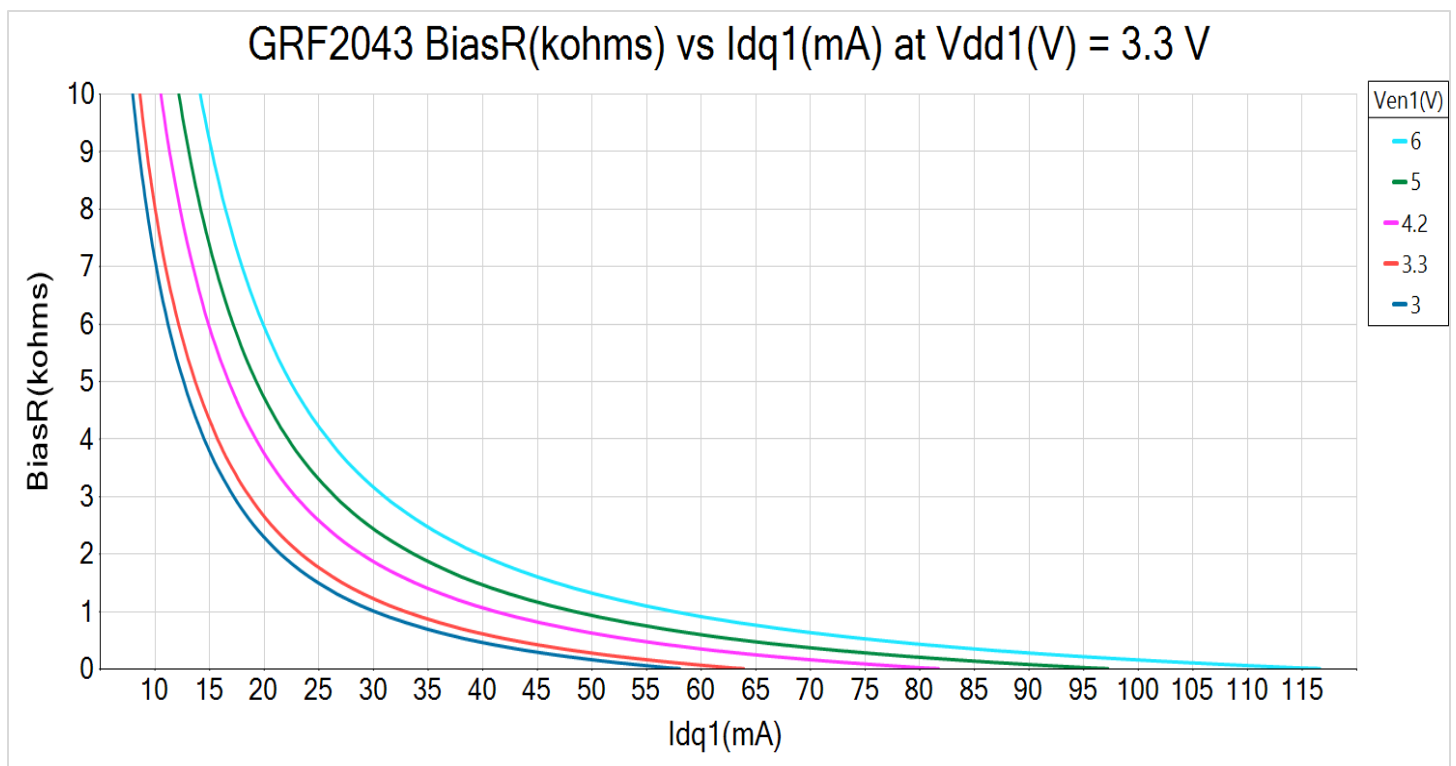
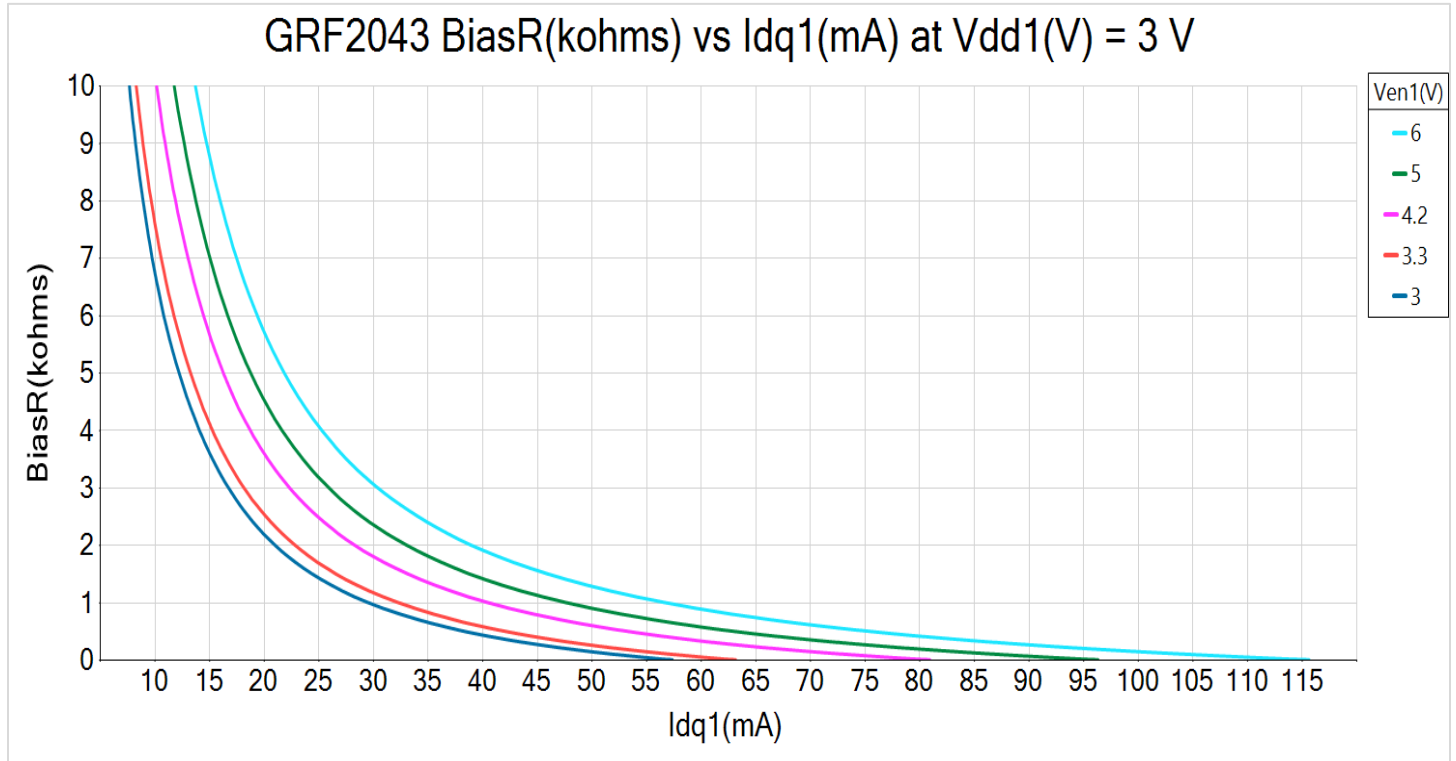

GRF2043 Bias Resistor Selection Curves:

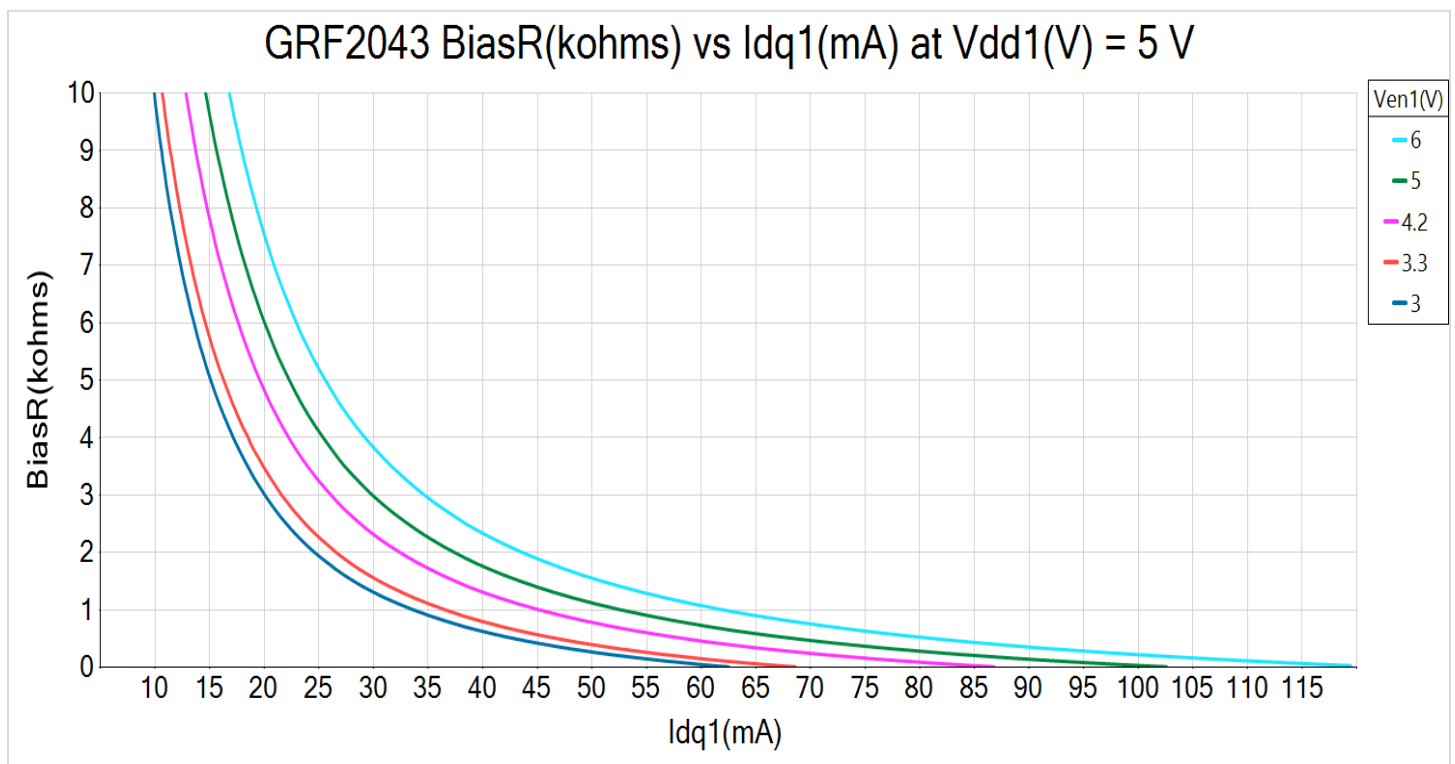
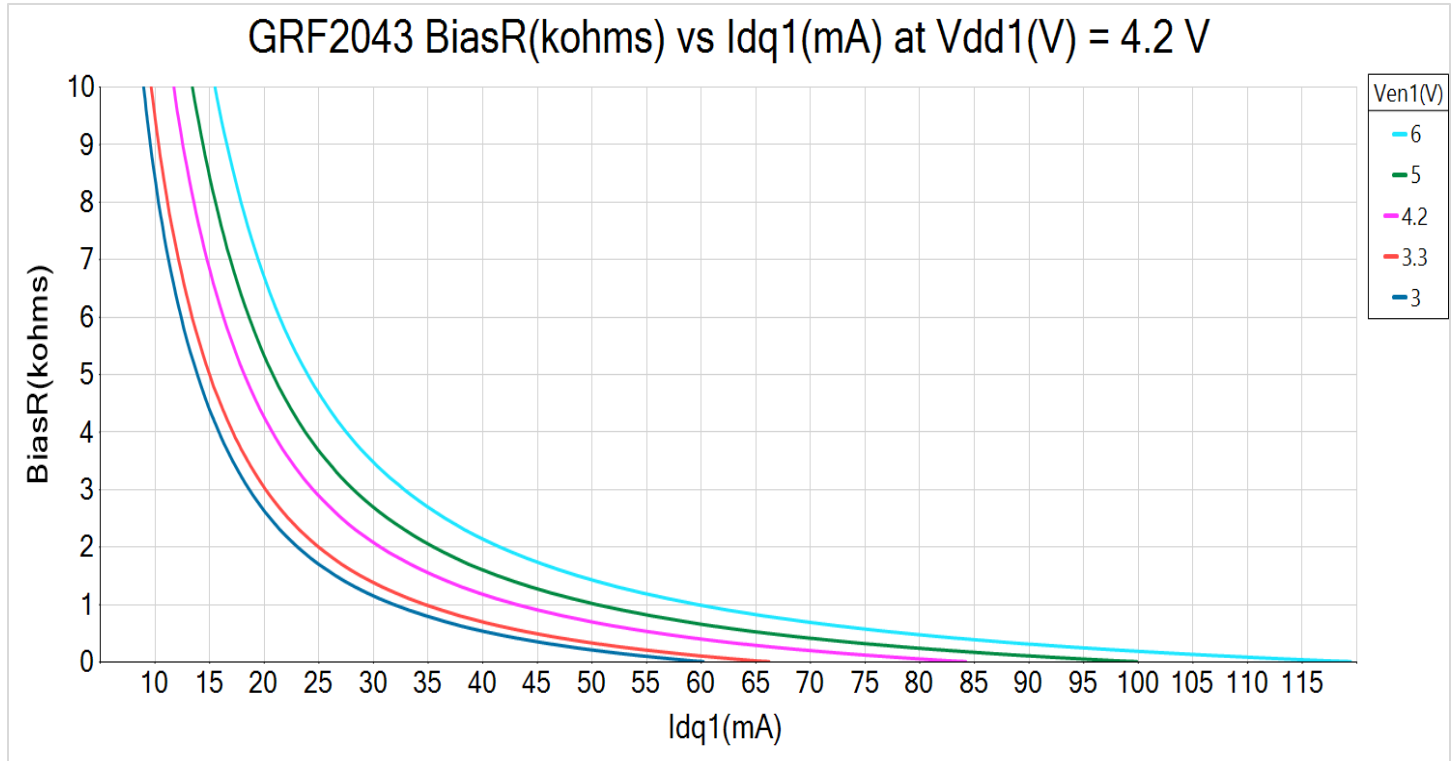

GRF2043 Bias Resistor Selection Curves:

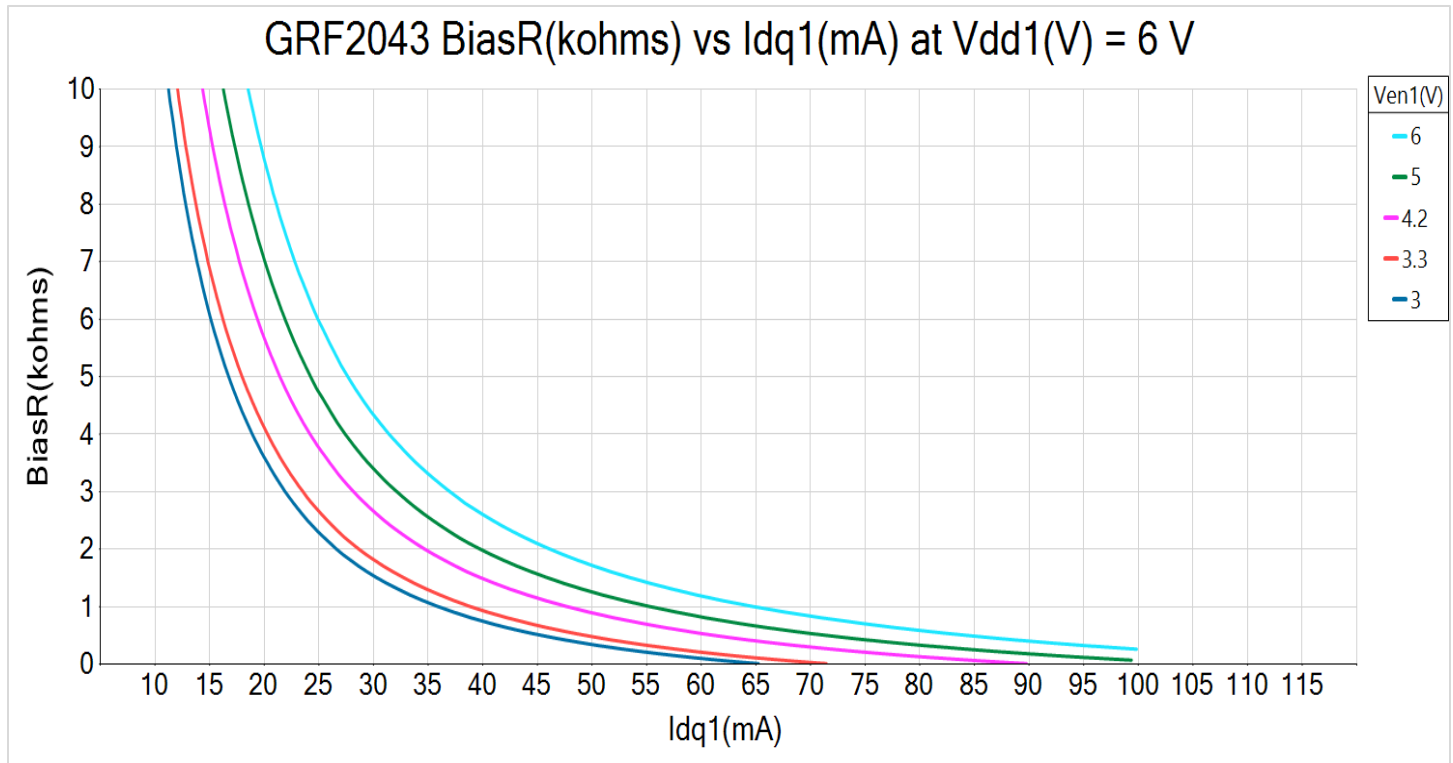

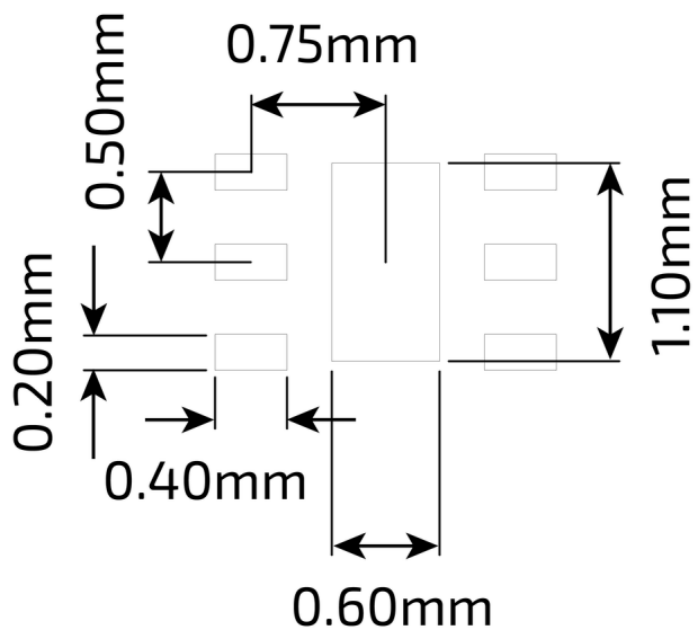

DFN-6 1.5 x 1.5 mm Suggested PCB Footprint (Top View)

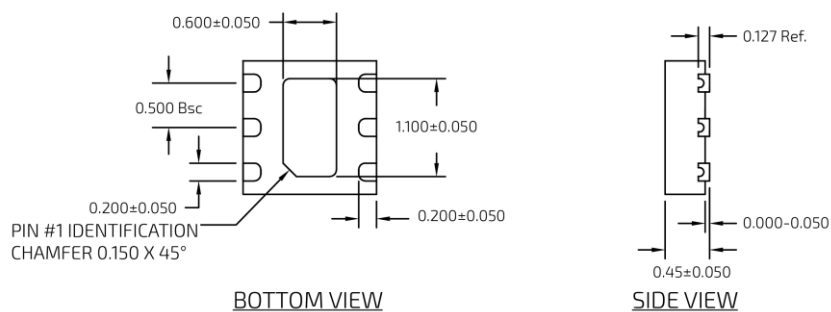
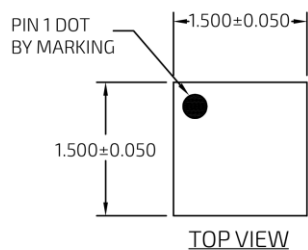

DFN-6 1.5 x 1.5 mm DFN-6 Package Dimensions

Package Marking Diagram



- Line 1: "Y" = YEAR (single digit). "WW" = WORK WEEK the device was assembled.
- Line 2: "XXXX" = Device PART NUMBER.

Tape and Reel Information

Guerrilla RF's tape and reel specification complies with Electronic Industries Alliance (EIA) standards for "Embossed Carrier Tape of Surface Mount Components for Automatic Handling" (reference EIA-481). See the following page for the Tape and Reel Specification and Device Package Information table, which includes units per reel.

Devices are loaded with pins down into the carrier pocket with protective cover tape and reeled onto a plastic reel. Each reel is packaged in a cardboard box. There are product labels on the reel, the protective ESD bag and the outside surface of the box.

For the Tape and Reel Reference Table, please refer to: [Package Manufacturing Information | Guerrilla RF \(guerrilla-rf.com\)](#)

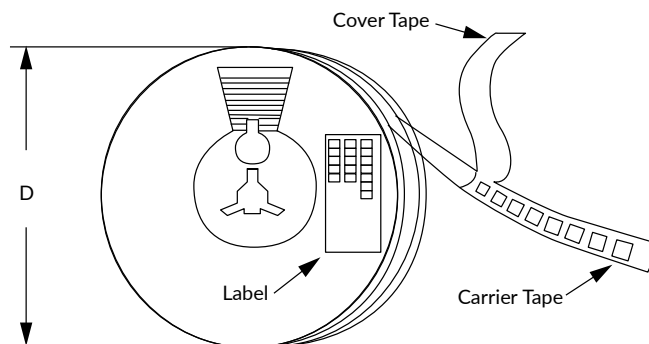

Tape and Reel Packaging with Reel Diameter Noted (D)

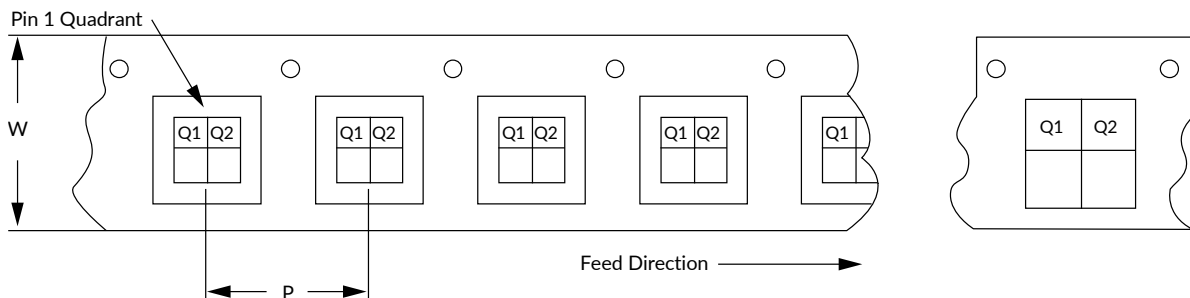

Carrier Tape Width (W), Pitch (P), Feed Direction and Pin 1 Quadrant Information



Revision History

Revision Date	Description of Change
March 2, 2020	Preliminary Data Sheet.
November 18, 2022	Release Ø Data Sheet. Upgraded Data Sheet to new format. Added new characterization plots. Added new bias resistor selection curves.
December 20, 2022	Raised RF input power in Gain Mode (P_{INMAX}) from 10 to 27 dBm. Added RF input power in Bypass Mode (P_{INMAX}).
June 25, 2024	Upgraded Data Sheet to new format only. No change to device or device specifications.
November 26, 2025	Upgraded Data Sheet to new format only. No change to device or device specifications.



Data Sheet Classifications

Data Sheet Status	Notes
Advance	S-parameter and NF data based on EM simulations for the fully packaged device using foundry-supplied transistor S-parameters. Linearity estimates based on device size, bias condition and experience with related devices.
Preliminary	All data based on limited evaluation board measurements taken within the Guerrilla RF Applications Lab. All parametric values are subject to change pending the collection of additional data.
Release Ø	All data based on measurements taken with <i>production-released</i> material. TYP values are based on a combination of ATE and bench-level measurements, with MIN/MAX limits defined using <i>modelled estimates</i> that account for part-to-part variations and expected process spreads. Although unlikely, future refinements to the TYP/MIN/MAX values may be in order as multiple lots are processed through the factory.
Release A-Z	All data based on measurements taken with production-released material <i>derived from multiple lots which have been fabricated over an extended period of time</i> . MIN/MAX limits may be refined over previous releases as more statistically significant data is collected to account for process spreads.

Information in this Data Sheet is specific to the Guerrilla RF, Inc. ("Guerrilla RF") product identified.

This Data Sheet, including the information contained in it, is provided by Guerrilla RF as a service to its customers and may be used for informational purposes only by the customer. Guerrilla RF assumes no responsibility for errors or omissions on this data sheet or the information contained herein. Information provided is believed to be accurate and reliable, however, no responsibility is assumed by Guerrilla RF for its use, nor for any infringement of patents, or other rights of third parties, resulting from its use. Guerrilla RF assumes no liability for any data sheet, data sheet information, materials, products, product information, or other information provided hereunder, including the sale, distribution, reproduction or use of Guerrilla RF products, information, or materials.

No license, whether express, implied, by estoppel, by implication or otherwise is granted by this data sheet for any intellectual property of Guerrilla RF, or any third party, including without limitation, patents, patent rights, copyrights, trademarks, and trade secrets. All rights are reserved by Guerrilla RF.

All information herein, products, product information, data sheets, and data sheet information are subject to change and availability without notice. Guerrilla RF reserves the right to change component circuitry, recommended application circuitry and specifications at any time without prior notice. Guerrilla RF may further change its data sheet, product information, documentation, products, services, specifications, or product descriptions at any time, without notice. Guerrilla RF makes no commitment to update any materials or information and shall have no responsibility whatsoever for conflicts, incompatibilities, or other difficulties arising from any future changes.

GUERRILLA RF INFORMATION, PRODUCTS, PRODUCT INFORMATION, DATA SHEETS AND DATA SHEET INFORMATION ARE PROVIDED "AS IS" AND WITHOUT WARRANTY OF ANY KIND, WHETHER EXPRESS, IMPLIED, STATUTORY, OR OTHERWISE, INCLUDING FITNESS FOR A PARTICULAR PURPOSE OR USE, MERCHANTABILITY, PERFORMANCE, QUALITY OR NON-INFRINGEMENT OF ANY INTELLECTUAL PROPERTY RIGHT; ALL SUCH WARRANTIES ARE HEREBY EXPRESSLY DISCLAIMED. GUERRILLA RF DOES NOT WARRANT THE ACCURACY OR COMPLETENESS OF THE INFORMATION, TEXT, GRAPHICS OR OTHER ITEMS CONTAINED WITHIN THESE MATERIALS. GUERRILLA RF SHALL NOT BE LIABLE FOR ANY DAMAGES, INCLUDING BUT NOT LIMITED TO ANY SPECIAL, INDIRECT, INCIDENTAL, STATUTORY, OR CONSEQUENTIAL DAMAGES, INCLUDING WITHOUT LIMITATION, LOST REVENUES OR LOST PROFITS THAT MAY RESULT FROM THE USE OF THE MATERIALS OR INFORMATION, WHETHER OR NOT THE RECIPIENT OF MATERIALS HAS BEEN ADVISED OF THE POSSIBILITY OF SUCH DAMAGE.

Customers are solely responsible for their use of Guerrilla RF products in the Customer's products and applications or in ways which deviate from Guerrilla RF's published specifications, either intentionally or as a result of design defects, errors, or operation of products outside of published parameters or design specifications. Customers should include design and operating safeguards to minimize these and other risks. Guerrilla RF assumes no liability or responsibility for applications assistance, customer product design, or damage to any equipment resulting from the use of Guerrilla RF products outside of stated published specifications or parameters.