

Connectors for Automobiles

Connect with the Best

How to choose connectors Notes on usage Catalogue PDF

results

Product information

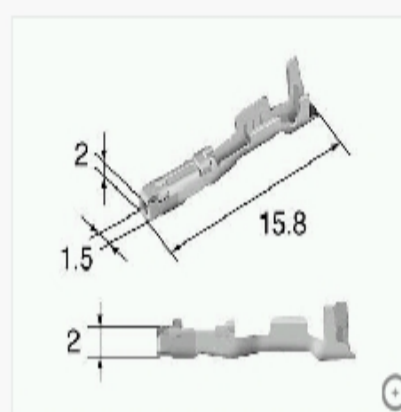

(Unit: mm)

Contact us for products

8100-3456

TS sealed series

Terminal For AV Wire

0.64mm(025)

Sealed/Unsealed	sealed
Male/Female	F
Tab Size	0.64mm(025)
Size	M
Mating parts	8100-3708 (TS sealed series)

Applicable wire size	0.22-0.35mm ²
Materials	Heat-resistant copper alloy
Surface treatment	Gold-plated
Contact resistance	Initial 8mΩ Max. after durability tests 16mΩ Max.
Leak current	50μA Max.
Insulation resistance	100MΩ Min.

TS sealed series 0.64mm(025) related products

▶ Housing (31)

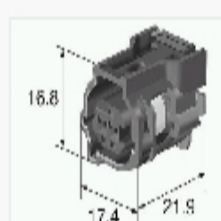

[0.64mm 6189-1161](#)

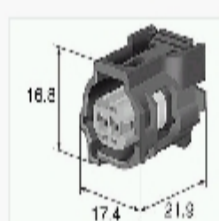

[0.64mm 6189-7020](#)

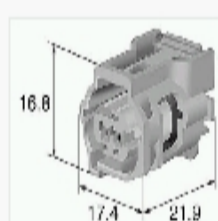

[0.64mm 6189-7073](#)



[0.64mm 6189-1129](#)

Show all results

▶ Wire seals (5)

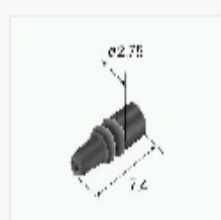

[0.64mm 7165-1043](#)

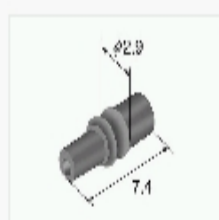

[0.64mm 7165-1312](#)

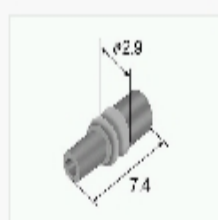

[0.64mm 7165-1198](#)



[0.64mm 7165-1199](#)

Show all results