



TF252TH

N-Channel JFET 20V, 140 to 350 μ A, 1.4mS, VTFP

ON Semiconductor®

<http://onsemi.com>

Features

- High gain : $GV=1.0\text{dB typ}$ ($V_{CC}=2\text{V}$, $R_L=2.2\text{k}\Omega$, $C_{in}=5\text{pF}$, $V_{IN}=10\text{mV}$, $f=1\text{kHz}$)
- Ultrasmall package facilitates miniaturization in end products
- Best suited for use in electret condenser microphone for audio equipments and telephones
- Excellent voltage characteristics
- Excellent transient characteristics
- Adoption of FBET process
- Halogen free compliance

Specifications

Absolute Maximum Ratings at $T_a=25^\circ\text{C}$

Parameter	Symbol	Conditions	Ratings	Unit
Gate-to-Drain Voltage	V_{GDO}		-20	V
Gate Current	I_G		10	mA
Drain Current	I_D		1	mA
Allowable Power Dissipation	P_D		100	mW
Junction Temperature	T_j		150	$^\circ\text{C}$
Storage Temperature	T_{stg}		-55 to +150	$^\circ\text{C}$

Stresses exceeding Maximum Ratings may damage the device. Maximum Ratings are stress ratings only. Functional operation above the Recommended Operating Conditions is not implied. Extended exposure to stresses above the Recommended Operating Conditions may affect device reliability.

Package Dimensions

unit : mm (typ)

7031A-001

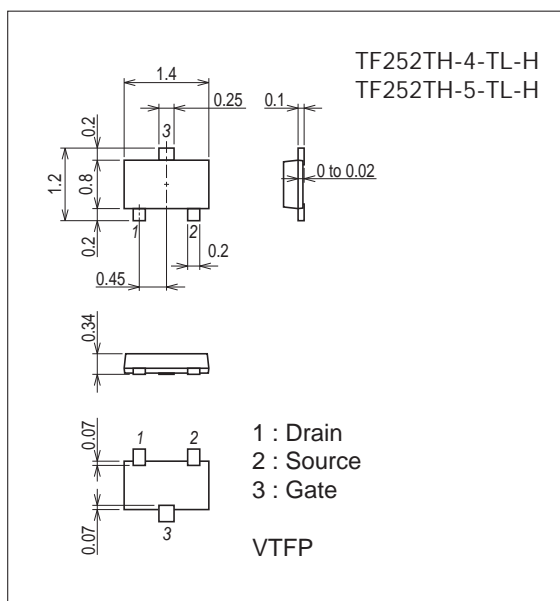

Product & Package Information

- Package : VTFP
- JEITA, JEDEC : SC-106A
- Minimum Packing Quantity : 8,000 pcs./reel

Packing Type: TL

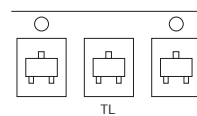

Marking

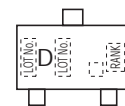

Electrical Connection

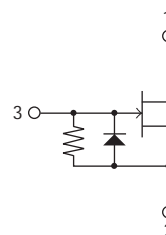

TF252TH

Electrical Characteristics at Ta=25°C

Parameter	Symbol	Conditions	Ratings			Unit
			min	typ	max	
Gate-to-Drain Breakdown Voltage	V(BR)GDO	I _G =-100μA	-20			V
Cutoff Voltage	V _{GS(off)}	V _{DS} =2V, I _D =1μA	-0.1	-0.4	-1.0	V
Drain Current	I _{DSS}	V _{DS} =2V, V _{GS} =0V	140*		350*	μA
Forward Transfer Admittance	y _{fs}	V _{DS} =2V, V _{GS} =0V, f=1kHz	0.8	1.4		mS
Input Capacitance	C _{iss}	V _{DS} =2V, V _{GS} =0V, f=1MHz		3.1		pF
Reverse Transfer Capacitance	C _{rss}			0.95		pF
[Ta=25°C, V _{CC} =2.0V, R _L =2.2kΩ, C _{in} =5pF, See specified Test Circuit.]						
Voltage Gain	G _V	V _{IN} =10mV, f=1kHz		1.0		dB
Reduced Voltage Characteristic	ΔG _{VV}	V _{IN} =10mV, f=1kHz, V _{CC} =2.0V → 1.5V		-0.6	-2.0	dB
Frequency Characteristic	ΔG _{Vf}	f=1kHz to 110Hz			-1.0	dB
Total Harmonic Distortion	THD	V _{IN} =30mV, f=1kHz		0.65		%
Output Noise Voltage	V _{NO}	V _{IN} =0V, A curve		-106	-102	dB

* : The TF252TH is classified by I_{DSS} as follows : (unit : μA)

Rank	4	5
I _{DSS}	140 to 240	210 to 350

Test Circuit

- Voltage gain
- Frequency Characteristic
- Distortion
- Reduced Voltage Characteristic

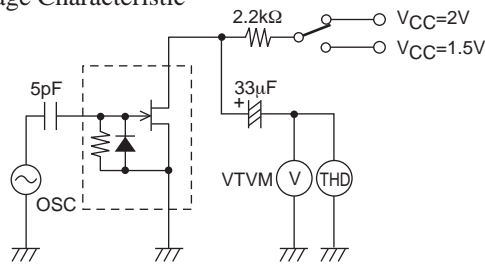

Ordering Information

Device	Package	Shipping	memo
TF252TH-4-TL-H	VTFP	8,000pcs./reel	Pb Free and Halogen Free
TF252TH-5-TL-H	VTFP	8,000pcs./reel	

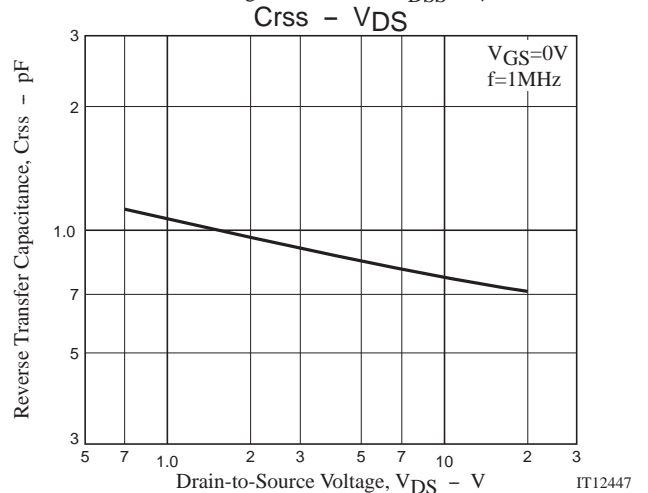
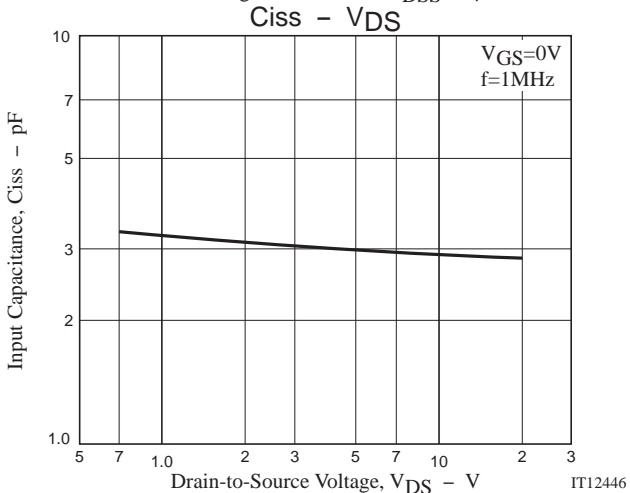
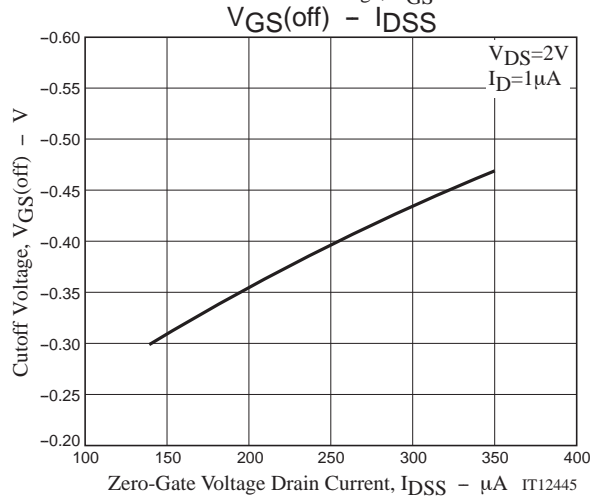
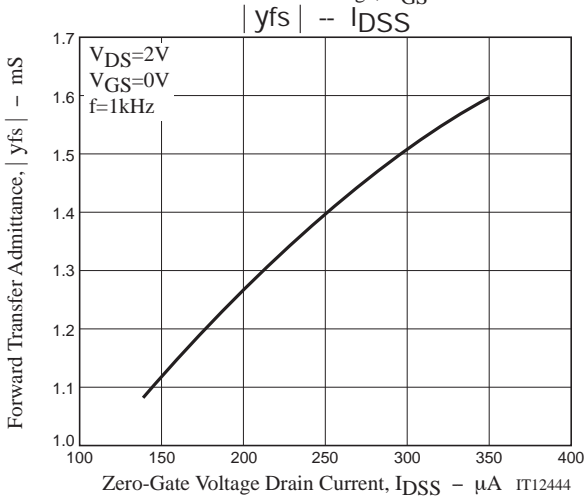
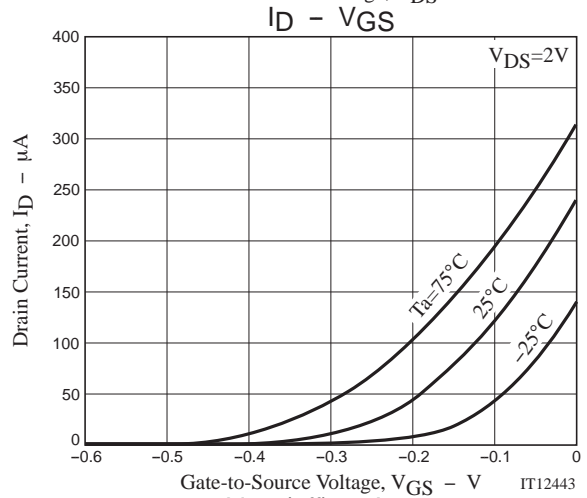
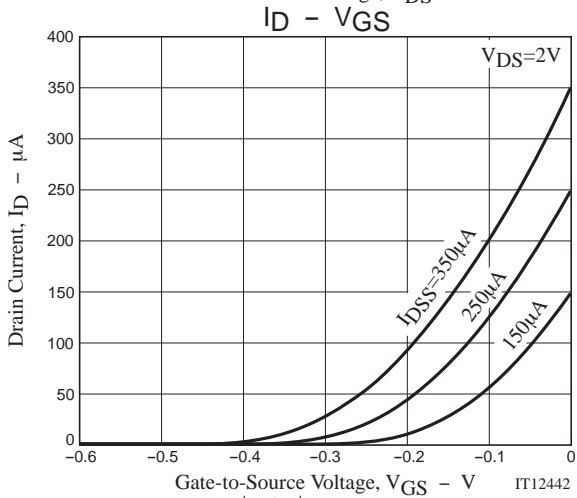
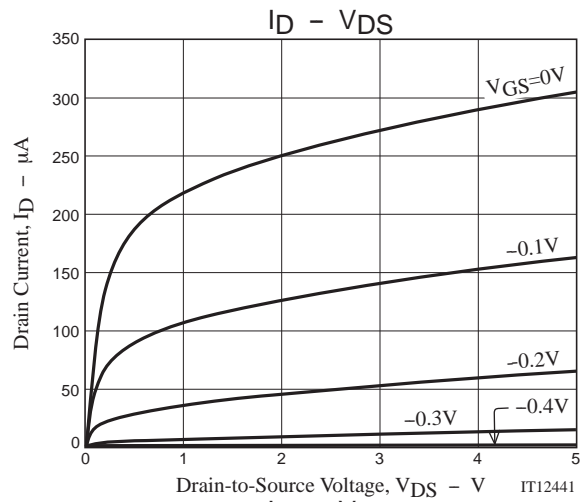
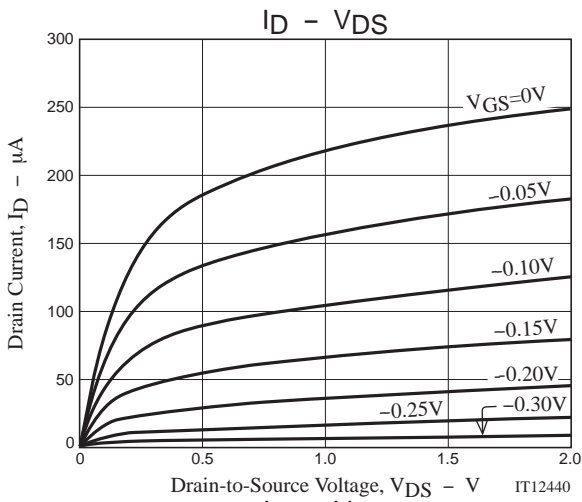

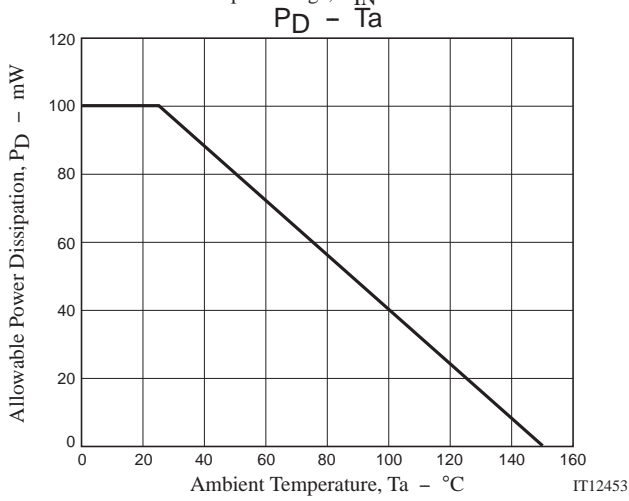
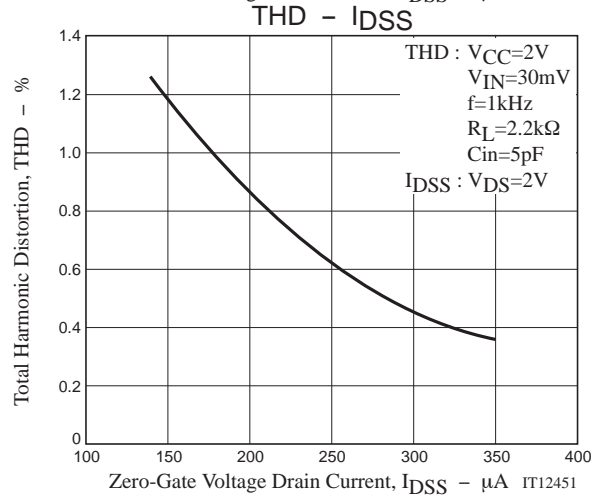
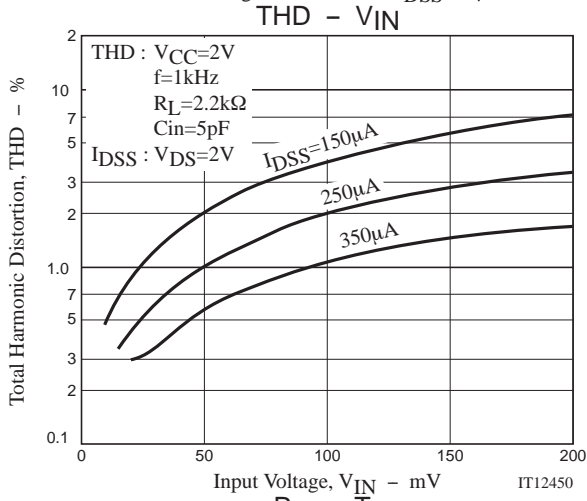
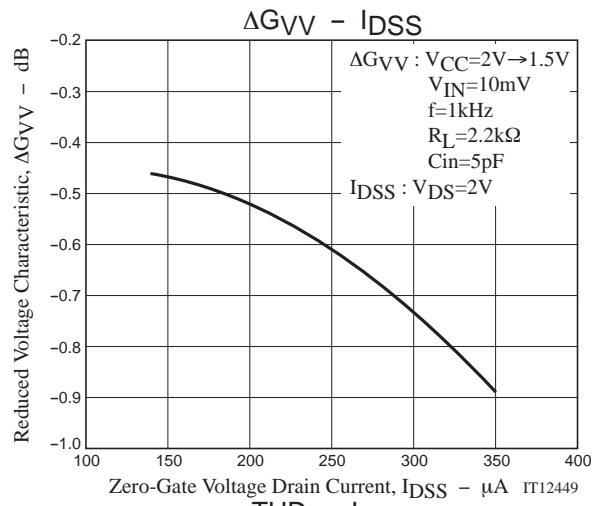
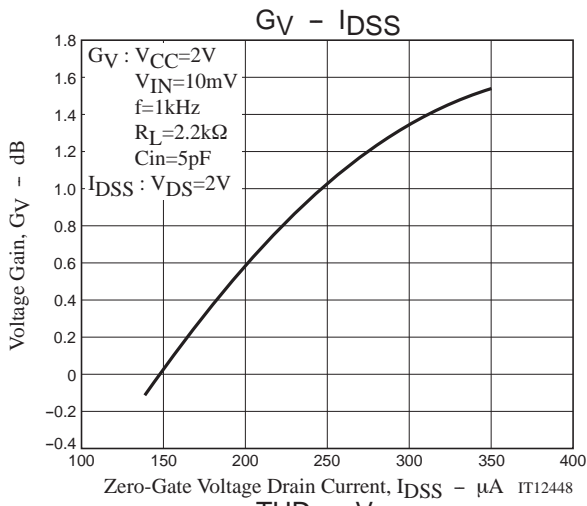

TF252TH

Taping Specification

TF252TH-4-TL-H, TF252TH-5-TL-H

1. Packing Format

Package Name	Carrier Tape Type	Maximum Number of devices contained (pcs)			Packing format	
		Reel	Inner box	Outer box	Inner BOX (C-1)	Outer BOX (A-7)
VTFP	VSFP	8,000	40,000	240,000	5 reels contained Dimensions:mm (external) 183×72×185	6 inner boxes contained Dimensions:mm (external) 440×195×210

Packing method

Reel label, Inner box label (unit :mm)

Outer box label
It is a label at the time of factory shipments.
The form of a label may change in physical distribution process.

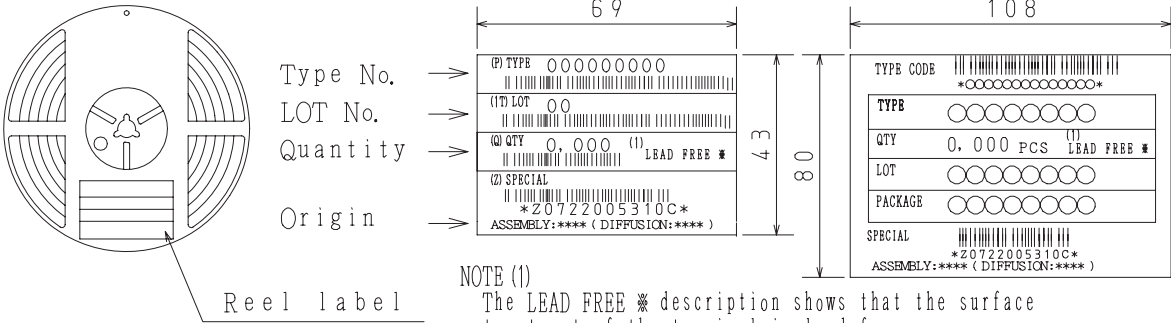

Label	JEITA Phase
LEAD FREE 3	JEITA Phase 3A
LEAD FREE 4	JEITA Phase 3

2. Taping configuration

2-1. Carrier tape size (unit:mm)

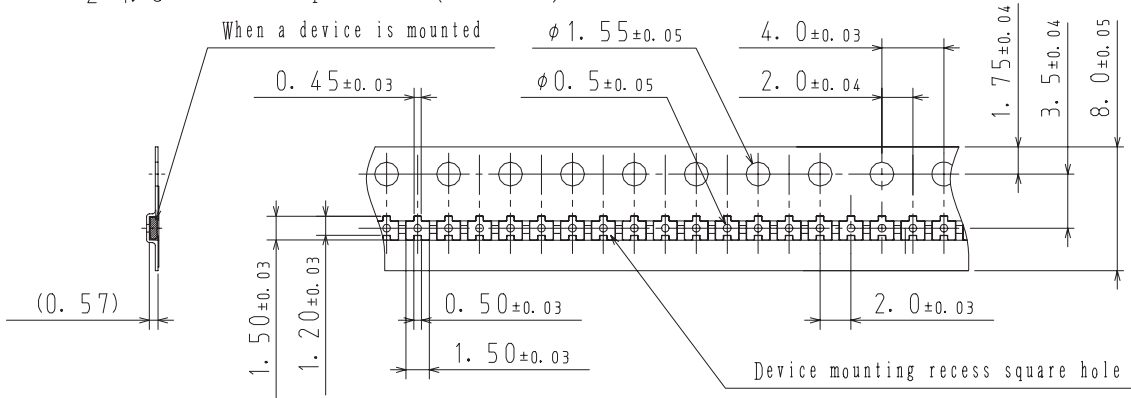

2-2. Device placement direction

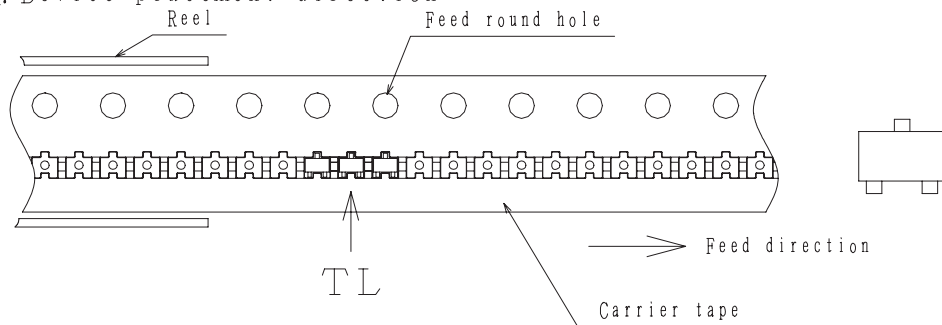

Those with oen electrode terminal on the feed hole side.....TL

ON Semiconductor and the ON logo are registered trademarks of Semiconductor Components Industries, LLC (SCILLC). SCILLC owns the rights to a number of patents, trademarks, copyrights, trade secrets, and other intellectual property. A listing of SCILLC's product/patent coverage may be accessed at www.onsemi.com/site/pdf/Patent-Marking.pdf. SCILLC reserves the right to make changes without further notice to any products herein. SCILLC makes no warranty, representation or guarantee regarding the suitability of its products for any particular purpose, nor does SCILLC assume any liability arising out of the application or use of any product or circuit, and specifically disclaims any and all liability, including without limitation special, consequential or incidental damages. "Typical" parameters which may be provided in SCILLC data sheets and/or specifications can and do vary in different applications and actual performance may vary over time. All operating parameters, including "Typicals" must be validated for each customer application by customer's technical experts. SCILLC does not convey any license under its patent rights nor the rights of others. SCILLC products are not designed, intended, or authorized for use as components in systems intended for surgical implant into the body, or other applications intended to support or sustain life, or for any other application in which the failure of the SCILLC product could create a situation where personal injury or death may occur. Should Buyer purchase or use SCILLC products for any such unintended or unauthorized application, Buyer shall indemnify and hold SCILLC and its officers, employees, subsidiaries, affiliates, and distributors harmless against all claims, costs, damages, and expenses, and reasonable attorney fees arising out of, directly or indirectly, any claim of personal injury or death associated with such unintended or unauthorized use, even if such claim alleges that SCILLC was negligent regarding the design or manufacture of the part. SCILLC is an Equal Opportunity/Affirmative Action Employer. This literature is subject to all applicable copyright laws and is not for resale in any manner.