

# TPD4E6B06 4-Channel Bidirectional Low Capacitance ESD Protection Device With 15-kV Contact and Ultra-Low Clamping Voltage

## 1 Features

- IEC 61000-4-2 Level 4
  - $\pm 15$ -kV Contact Discharge
  - $\pm 15$ -kV Air Gap Discharge
- IEC 61000-4-5 (Surge): 3 A (8/20  $\mu$ s)
- IO Capacitance: 4.8 pF (Typical)
- $R_{DYN}$ : 0.75  $\Omega$  (Typical)
- DC Breakdown Voltage:  $\pm 6$  V (Minimum)
- Ultra Low Leakage Current: 100 nA (Maximum)
- Clamping Voltage: 10 V (Maximum at  $I_{PP} = 1$  A)
- Industrial Temperature Range:  $-40^{\circ}\text{C}$  to  $+125^{\circ}\text{C}$
- Space Saving DPW Package (0.8 mm  $\times$  0.8 mm)

## 2 Applications

- Audio Lines
  - Microphone
  - Earphone
  - Speakerphone
- SD Interface
- SIM Interface
- Mobile Keyboard or Other Buttons
- Cell Phones
- eBook
- Portable Media Players
- Digital Camera
- Tablet PC
- Wearables

## 3 Description

The TPD4E6B06 is a four channel electrostatic discharge (ESD) protection device in an ultra small DPW package. It is the industry's smallest 4-channel transient voltage suppressor (TVS) diode with a 0.48-mm pitch. This larger pitch helps save on printed-circuit board (PCB) manufacturing costs. The device provides IEC61000-4-2 compliance up to 15-kV contact discharge. It has an ESD clamp circuit with back-to-back diodes for bipolar-bidirectional signal support. The 4.8-pF (typical) line capacitance is suitable for a wide range of applications supporting data rates up to 700 MHz.

### Device Information<sup>(1)</sup>

PART NUMBER	PACKAGE	BODY SIZE (NOM)
TPD4E6B06	X2SON (4)	0.80 mm $\times$ 0.80 mm

(1) For all available packages, see the orderable addendum at the end of the data sheet.

Simplified Schematic

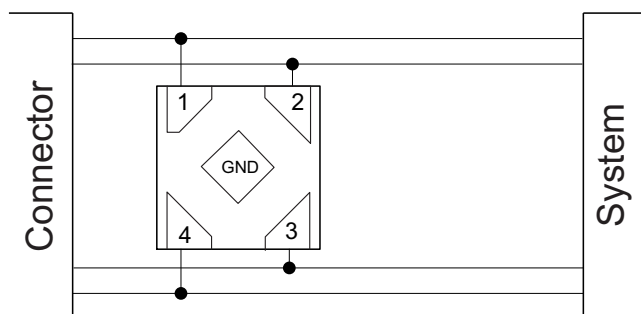

Pinout

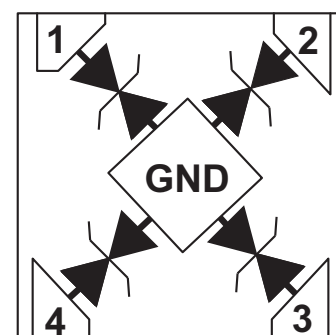

0.8 mm  $\times$  0.8mm X2SON Package  
(Bottom View)



## Table of Contents

<b>1 Features</b> .....	<b>1</b>	7.4 Device Functional Modes.....	<b>9</b>
<b>2 Applications</b> .....	<b>1</b>	<b>8 Application and Implementation</b> .....	<b>10</b>
<b>3 Description</b> .....	<b>1</b>	8.1 Application Information.....	<b>10</b>
<b>4 Revision History</b> .....	<b>2</b>	8.2 Typical Application .....	<b>10</b>
<b>5 Pin Configuration and Functions</b> .....	<b>3</b>	<b>9 Power Supply Recommendations</b> .....	<b>12</b>
<b>6 Specifications</b> .....	<b>4</b>	<b>10 Layout</b> .....	<b>12</b>
6.1 Absolute Maximum Ratings .....	4	10.1 Layout Guidelines .....	12
6.2 ESD Ratings.....	4	10.2 Layout Examples.....	12
6.3 Recommended Operating Conditions.....	4	<b>11 Device and Documentation Support</b> .....	<b>14</b>
6.4 Thermal Information .....	4	11.1 Documentation Support .....	14
6.5 Electrical Characteristics.....	5	11.2 Receiving Notification of Documentation Updates	14
6.6 Typical Characteristics .....	6	11.3 Community Resources.....	14
<b>7 Detailed Description</b> .....	<b>8</b>	11.4 Trademarks .....	14
7.1 Overview .....	8	11.5 Electrostatic Discharge Caution.....	14
7.2 Functional Block Diagram .....	8	11.6 Glossary .....	14
7.3 Feature Description.....	8	<b>12 Mechanical, Packaging, and Orderable Information</b> .....	<b>14</b>

## 4 Revision History

NOTE: Page numbers for previous revisions may differ from page numbers in the current version.

### Changes from Revision B (February 2017) to Revision C Page

- Added "Power Supply Recommendations" section .....

**12**

### Changes from Revision A (December 2015) to Revision B Page

- Changed the value of  $R_{DYN}$  from 0.75 and 0.65 to 0.45 and 0.42 respectively, in the [Electrical Characteristics](#) table .....

**5**

### Changes from Original (May 2014) to Revision A Page

- Updated the *Handling Ratings* table into an *ESD Ratings* table and moved  $T_{stg}$  to the *Absolute Maximum Ratings* table... **4**
- Added new note to *Absolute Maximum Ratings* table .....
- Added frequency test condition to *IO capacitance* in the *Electrical Characteristics* table..... **5**
- Added [Community Resources](#) .....

**14**

## 5 Pin Configuration and Functions

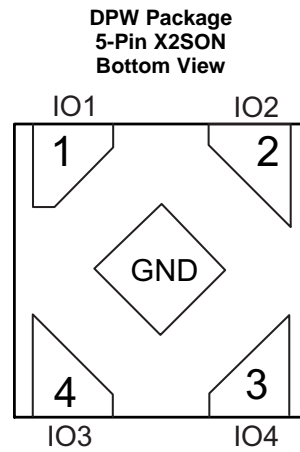

**Pin Functions**

PIN		I/O	DESCRIPTION
NO	NAME		
1	IO1	IO	ESD protected line
2	IO2	IO	ESD protected line
3	IO3	IO	ESD protected line
4	IO4	IO	ESD protected line
5	GND	—	Ground

## 6 Specifications

### 6.1 Absolute Maximum Ratings

over operating free-air temperature range (unless otherwise noted)<sup>(1)(2)(3)</sup>

		MIN	MAX	UNIT
Peak pulse	IEC 61000-4-5 Current ( $t_p - 8/20 \mu s$ ) <sup>(4)</sup>		3	A
	IEC 61000-4-5 Power ( $t_p - 8/20 \mu s$ ) <sup>(4)</sup>		40	W
Operating temperature		-40	125	°C
Storage temperature	$T_{stg}$	-65	155	°C

- (1) Stresses beyond those listed under *Absolute Maximum Ratings* may cause permanent damage to the device. These are stress ratings only, which do not imply functional operation of the device at these or any other conditions beyond those indicated under *Recommended Operating Conditions*. Exposure to absolute-maximum-rated conditions for extended periods may affect device reliability.
- (2) Absolute maximum ratings apply over recommended junction temperature range.
- (3) Voltages are with respect to GND unless otherwise noted.
- (4) Measured at 25°C.

### 6.2 ESD Ratings

		VALUE	UNIT
$V_{(ESD)}$ Electrostatic discharge	Human body model (HBM), per ANSI/ESDA/JEDEC JS-001, all pins <sup>(1)</sup>	±2000	V
	Charged device model (CDM), per JEDEC specification JESD22-C101, all pins <sup>(2)</sup>	±500	

- (1) JEDEC document JEP155 states that 500-V HBM allows safe manufacturing with a standard ESD control process. Pins listed as 2 kV may actually have higher performance.
- (2) JEDEC document JEP157 states that 250-V CDM allows safe manufacturing with a standard ESD control process. Pins listed as 500 V may actually have higher performance.

### 6.3 Recommended Operating Conditions

over operating free-air temperature range (unless otherwise noted)

		MIN	MAX	UNIT
$V_{IO}$	Input pin voltage	-5.5	5.5	V
$T_A$	Operating free-air temperature	-40	125	°C

### 6.4 Thermal Information

THERMAL METRIC <sup>(1)</sup>		TPD4E6B06	UNIT
		DPW (X2SON)	
		5 PINS	
$R_{\theta JA}$	Junction-to-ambient thermal resistance	291.8	°C/W
$R_{\theta JC(top)}$	Junction-to-case (top) thermal resistance	224.2	°C/W
$R_{\theta JB}$	Junction-to-board thermal resistance	245.8	°C/W
$\Psi_{JT}$	Junction-to-top characterization parameter	31.4	°C/W
$\Psi_{JB}$	Junction-to-board characterization parameter	245.6	°C/W
$R_{\theta JC(bot)}$	Junction-to-case (bottom) thermal resistance	195.4	°C/W

- (1) For more information about traditional and new thermal metrics, see the [Semiconductor and IC Package Thermal Metrics](#) application report.

## 6.5 Electrical Characteristics

$T_A = -40^\circ\text{C}$  to  $+125^\circ\text{C}$  (unless otherwise specified)

PARAMETER		TEST CONDITION	MIN	TYP	MAX	UNIT
$V_{RWM}$	Reverse stand-off voltage	$I_{IO} = 10 \mu\text{A}$	-5.5		5.5	V
$V_{BRF}$	Break-down voltage	$I_{IO \text{ to GND}} = 1 \text{ mA}$	6			V
$V_{BRR}$	Break-down voltage	$I_{GND \text{ to IO}} = 1 \text{ mA}$	6			V
$I_{LEAK}$	Leakage current	$V_{IO} = 5 \text{ V}$			100	nA
$V_{CLAMP}$	Clamp voltage with ESD strike	$I = 1 \text{ A, IO to GND, } 8/20 \mu\text{s}^{(1)}$		10		V
		$I = 5 \text{ A, IO to GND, } 8/20 \mu\text{s}^{(1)}$		13		V
		$I = 1 \text{ A, IO to GND, } 8/20 \mu\text{ss}^{(1)}$		9		V
		$I = 5 \text{ A, IO to GND, } 8/20 \mu\text{s}^{(1)}$		13		V
$R_{DYN}$	Dynamic resistance	Any IO to GND pin <sup>(2)</sup>		0.45		$\Omega$
		GND to any IO pin <sup>(2)</sup>		0.42		$\Omega$
$C_L$	IO capacitance	$V_{IO} = 2.5 \text{ V; } f = 10 \text{ MHz}$		4.8	7	pF

- (1) Non-repetitive current pulse 8/20  $\mu\text{s}$  exponentially decaying waveform according to IEC61000-4-5.  
 (2) Extraction of  $R_{DYN}$  using least squares fit of TLP characteristics between  $I = 10 \text{ A}$  and  $I = 20 \text{ A}$ .

## 6.6 Typical Characteristics

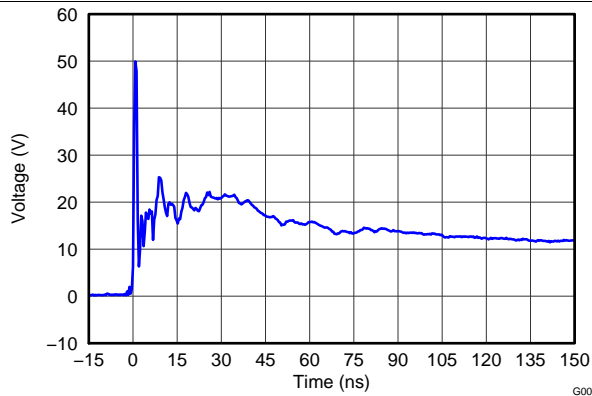

Figure 1. IEC 61000-4-2 Clamping Voltage, 8-kV Contact

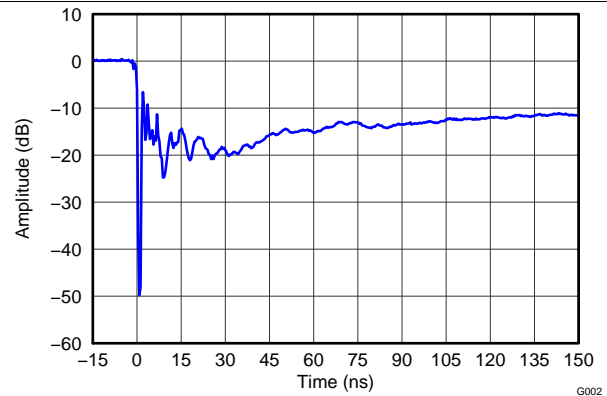

Figure 2. IEC 61000-4-2 Clamping Voltage, -8-kV Contact

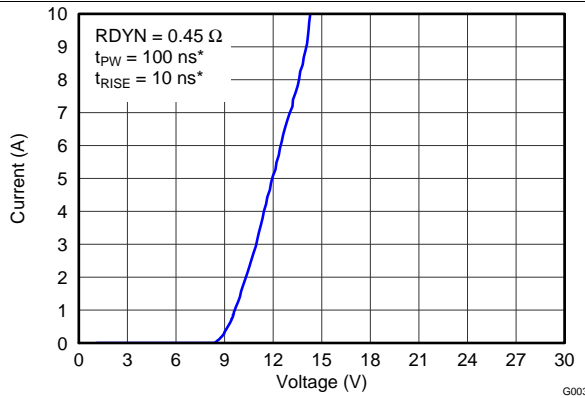

Figure 3. TLP,  $t_{PW} = 100 \text{ ns}$ ,  $t_{RISE} = 10 \text{ ns}$ , IO to GND

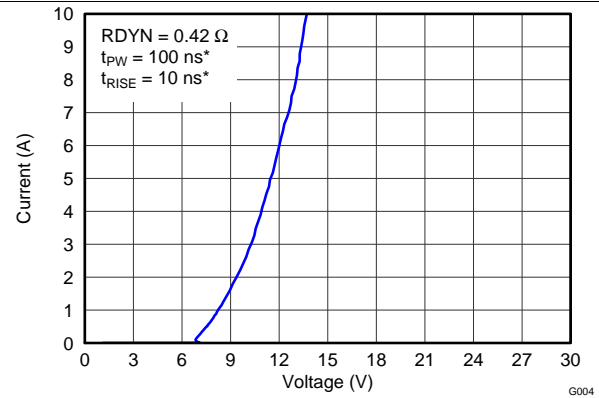

Figure 4. TLP,  $t_{PW} = 100 \text{ ns}$ ,  $t_{RISE} = 10 \text{ ns}$ , GND to IO

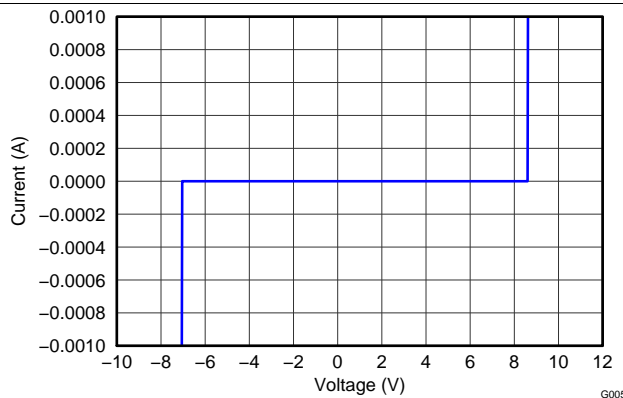

Figure 5. IV Curve

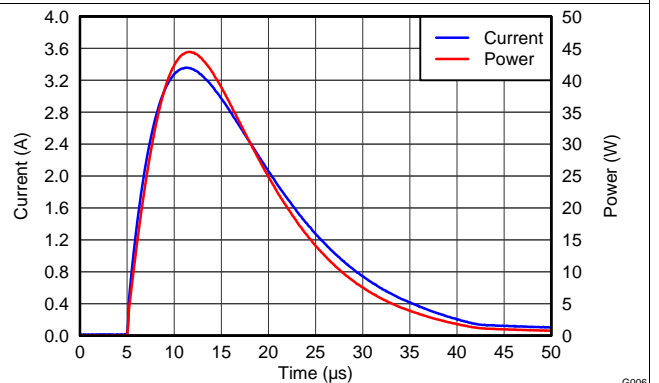
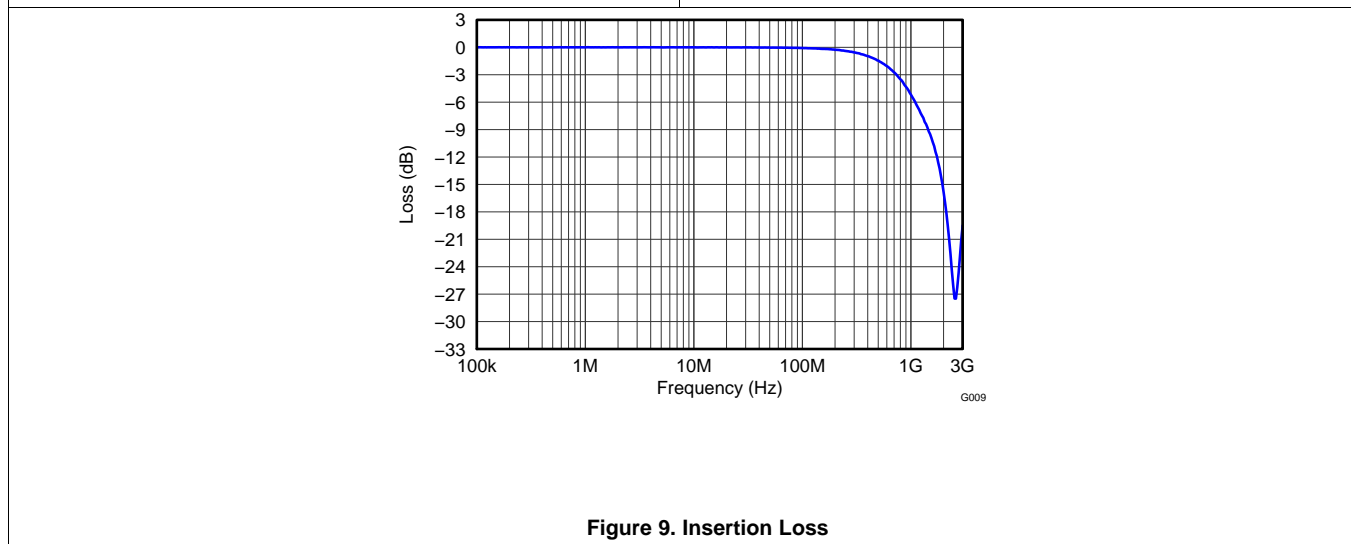
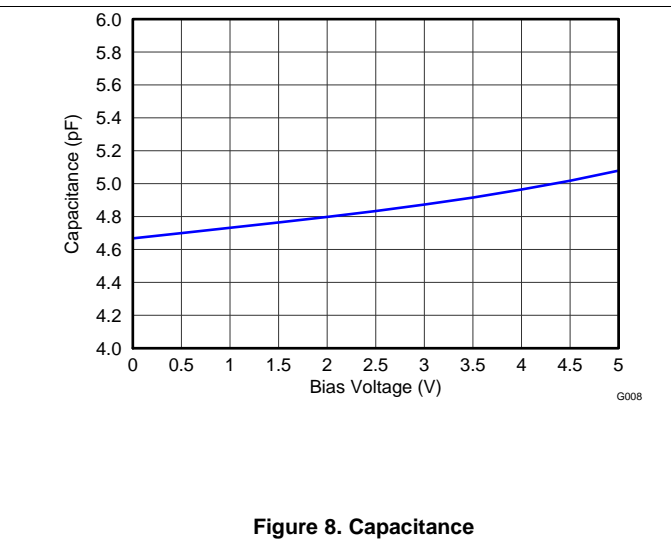
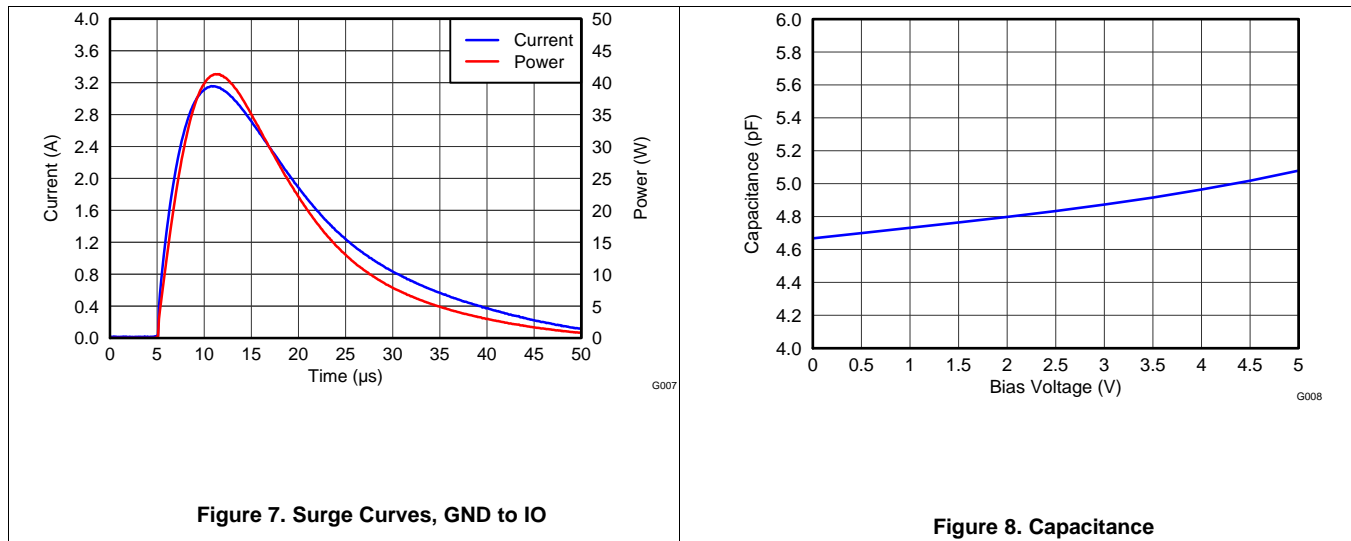

Figure 6. Surge Curves, IO to GND

Typical Characteristics (continued)



## 7 Detailed Description

### 7.1 Overview

The TPD4E6B06 is a four channel ESD Protection device in an ultra small DPW package. It is the industry's smallest 4-CH ESD protection device with 0.48-mm pitch. This larger pitch helps save on PCB manufacturing costs. The device provides IEC61000-4-2 compliance up to 15-kV contact discharge. It has an ESD clamp circuit with back-to-back diodes for bipolar/bidirectional signal support. The 4.8-pF (Typical) line capacitance is suitable for a wide range of applications supporting frequencies up to 700 MHz.

### 7.2 Functional Block Diagram

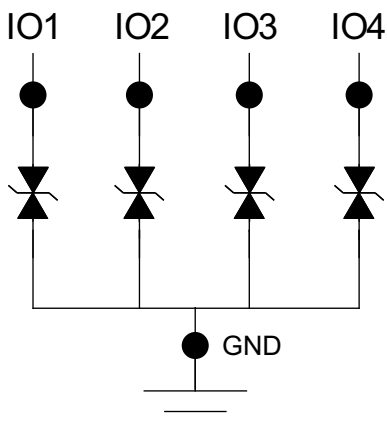

### 7.3 Feature Description

#### 7.3.1 IEC 61000-4-2 Level 2 ESD Protection

The IO pins can withstand ESD events up to  $\pm 15$ -kV contact and  $\pm 15$ -kV air. An ESD-surge clamp diverts the current to ground.

#### 7.3.2 IEC 61000-4-5 Surge Protection

The IO pins can withstand surge events up to 3 A and 40 W (8/20  $\mu$ s waveform). An ESD-surge clamp diverts this current to ground.

#### 7.3.3 IO Capacitance

The capacitance between any IO pin to ground is 4.8 pF (typical). This capacitance supports frequencies up to 700 MHz.

#### 7.3.4 $R_{DYN}$

The low  $R_{DYN}$  of 0.75  $\Omega$  (typical) allows for lower clamping voltages.

#### 7.3.5 DC Breakdown Voltage

The DC breakdown voltage of any IO pin is a minimum of  $\pm 6$  V. This ensures that sensitive equipment is protected from surges above the reverse standoff voltage of  $\pm 5.5$  V (minimum).

#### 7.3.6 Ultra-Low Leakage Current

The IO pins feature an ultra-low leakage current of 100 nA (maximum) with a bias of 2.5 V.

## Feature Description (continued)

### 7.3.7 Clamping Voltage

The IO pins feature an ESD clamp capable of clamping the voltage to 10 V (IO to GND) or 9 V (GND to IO) of IEC61000-4-5 surge when  $I_{PP} = 1$  A.

### 7.3.8 Industrial Temperature Range

This device features an industrial operating range of  $-40^{\circ}\text{C}$  to  $+125^{\circ}\text{C}$ .

### 7.3.9 Space Saving DPW Package

The small 0.8 mm  $\times$  0.8 mm package size saves board space and makes it easy to add ESD protection.

## 7.4 Device Functional Modes

The TPD4E6B06 is a passive integrated circuit that triggers when voltages are above  $V_{BRF}$  or  $V_{BRR}$ . During ESD events, voltages as high as  $\pm 15$  kV (air) can be directed to ground via the internal diode network. Once the voltages on the protected line fall below the trigger levels of the TPD4E6B06 (usually within 10s of nanoseconds) the device reverts to passive.

## 8 Application and Implementation

### NOTE

Information in the following applications sections is not part of the TI component specification, and TI does not warrant its accuracy or completeness. TI's customers are responsible for determining suitability of components for their purposes. Customers should validate and test their design implementation to confirm system functionality.

### 8.1 Application Information

The TPD4E6B06 is a diode array type TVS. These low capacitance types of TVSs are typically used to provide a path to ground for dissipating ESD events on hi speed signal lines between a human interface connector and a system. During high voltage ESD strikes, the device clamps to a safe voltage level to protect the system.

The typical application of the TPD4E6B06 is to be placed in between the connector and the system. The low capacitance of the TPD4E6B06 gives flexibility in the end application, as it can be used on many different high speed interfaces.

### 8.2 Typical Application

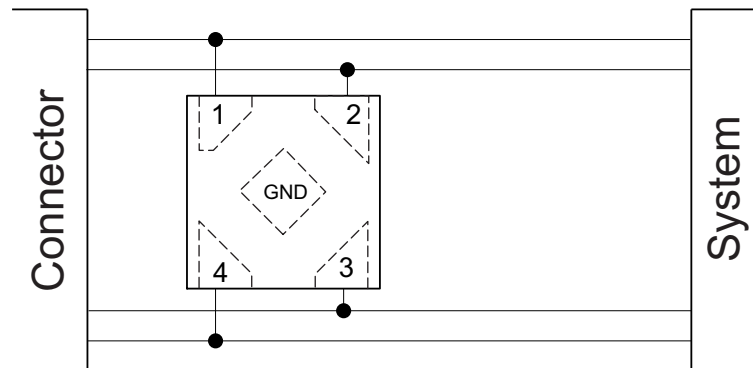

**Figure 10. Protecting Data Lines**

#### 8.2.1 Design Requirements

Table 1 shows the design parameters.

**Table 1. Design Parameters**

DESIGN PARAMETER	EXAMPLE VALUE
Signal range on data lines	–5.5 V to 5.5 V
Operating frequency	Up to 700 MHz

#### 8.2.2 Detailed Design Procedure

The designer needs to know the following:

- Signal range on all the protected lines
- Operating frequency

##### 8.2.2.1 Signal Range

The TPD4E6B06 has 4 protection channels for signal lines. Any I/O supports a signal range of –5.5 V to 5.5 V.

##### 8.2.2.2 Operating Frequency

The TPD4E6B06 has 4.8 pF of capacitance (Typical), supporting up to 700 MHz frequencies.

**8.2.3 Application Curve**

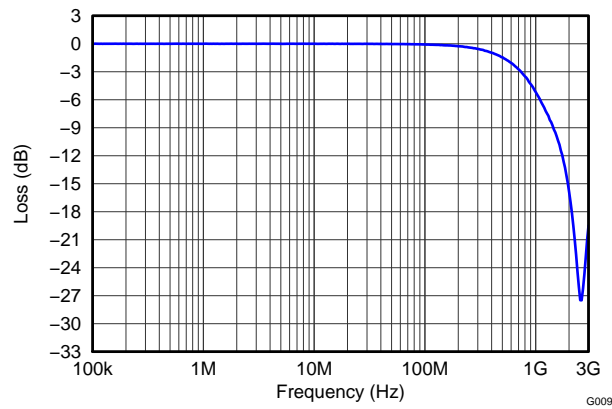

**Figure 11. Insertion Loss (Any IO to GND)**

## 9 Power Supply Recommendations

The TPD4E6B06 is a passive TVS diode-based ESD protection device, so there is no need to power it. Ensure that the maximum voltage specifications for each pin are not violated.

## 10 Layout

### 10.1 Layout Guidelines

- Place the device as close to the connector as possible.
  - EMI during an ESD event can couple from the trace being struck to other nearby unprotected traces, resulting in early system failures.
  - The PCB designer must minimize the possibility of EMI coupling by keeping any unprotected traces away from the protected traces which are between the TVS and the connector.
- Route the protected traces as straight as possible.
- Eliminate any sharp corners on the protected traces between the TVS and the connector by using rounded corners with the largest radii possible.
  - Electric fields tend to build up on corners, increasing EMI coupling.

### 10.2 Layout Examples

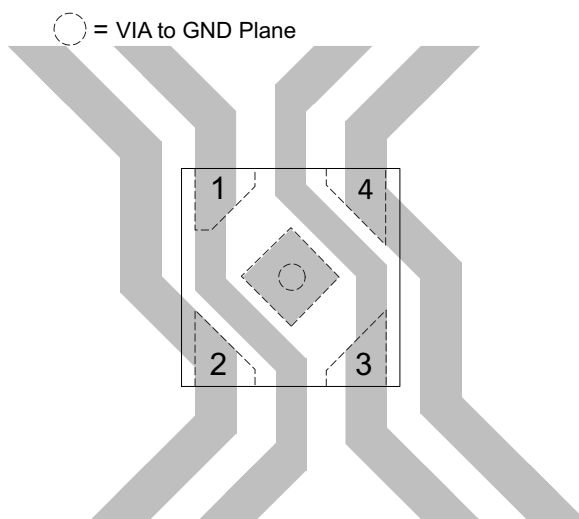

**Figure 12. Single Layer Routing**

### Layout Examples (continued)

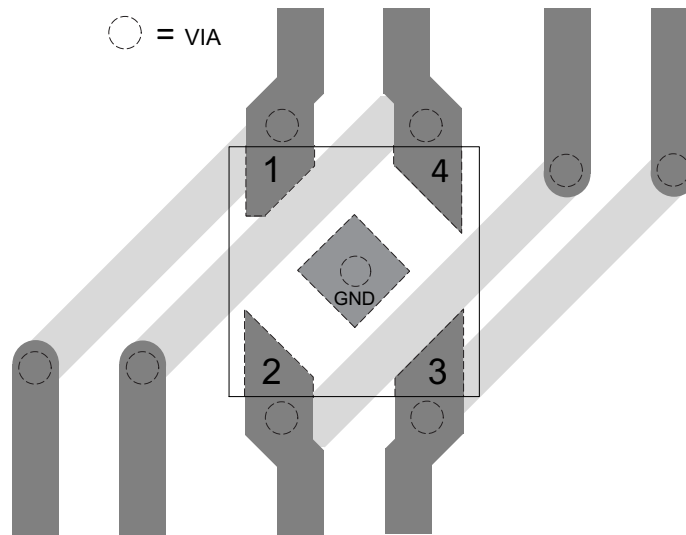

Figure 13. Double Layer Routing

## 11 Device and Documentation Support

### 11.1 Documentation Support

#### 11.1.1 Related Documentation

For related documentation, see the following:

- [Reading and Understanding an ESD Protection Datasheet](#)
- [ESD Layout Guide](#)

### 11.2 Receiving Notification of Documentation Updates

To receive notification of documentation updates, navigate to the device product folder on [ti.com](http://ti.com). In the upper right corner, click on *Alert me* to register and receive a weekly digest of any product information that has changed. For change details, review the revision history included in any revised document.

### 11.3 Community Resources

The following links connect to TI community resources. Linked contents are provided "AS IS" by the respective contributors. They do not constitute TI specifications and do not necessarily reflect TI's views; see TI's [Terms of Use](#).

**TI E2E™ Online Community** *TI's Engineer-to-Engineer (E2E) Community*. Created to foster collaboration among engineers. At [e2e.ti.com](http://e2e.ti.com), you can ask questions, share knowledge, explore ideas and help solve problems with fellow engineers.

**Design Support** *TI's Design Support* Quickly find helpful E2E forums along with design support tools and contact information for technical support.

### 11.4 Trademarks

E2E is a trademark of Texas Instruments.  
All other trademarks are the property of their respective owners.

### 11.5 Electrostatic Discharge Caution



These devices have limited built-in ESD protection. The leads should be shorted together or the device placed in conductive foam during storage or handling to prevent electrostatic damage to the MOS gates.

### 11.6 Glossary

[SLYZ022](#) — *TI Glossary*.

This glossary lists and explains terms, acronyms, and definitions.

## 12 Mechanical, Packaging, and Orderable Information

The following pages include mechanical, packaging, and orderable information. This information is the most current data available for the designated devices. This data is subject to change without notice and revision of this document. For browser-based versions of this data sheet, refer to the left-hand navigation.



**DPW0004A**

**PACKAGE OUTLINE**

**X2SON - 0.4 mm max height**

PLASTIC SMALL OUTLINE - NO LEAD

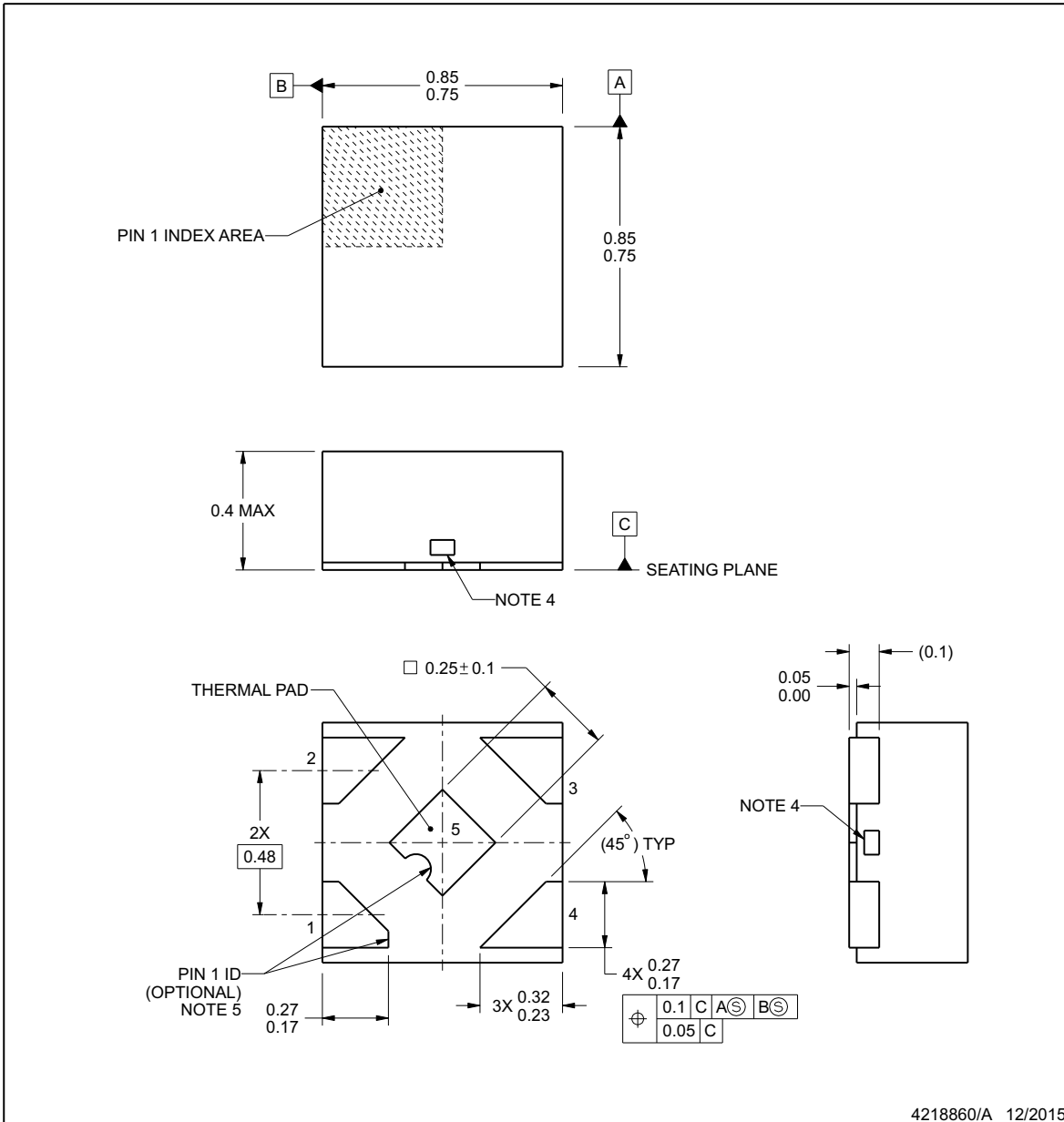

**NOTES:**

1. All linear dimensions are in millimeters. Any dimensions in parenthesis are for reference only. Dimensioning and tolerancing per ASME Y14.5M.
2. This drawing is subject to change without notice.
3. The package thermal pad must be soldered to the printed circuit board for thermal and mechanical performance.
4. The size and shape of this feature may vary.
5. Features may not exist. Recommend use of pin 1 marking on top of package for orientation purposes.

**EXAMPLE BOARD LAYOUT**

**DPW0004A**

**X2SON - 0.4 mm max height**

PLASTIC SMALL OUTLINE - NO LEAD

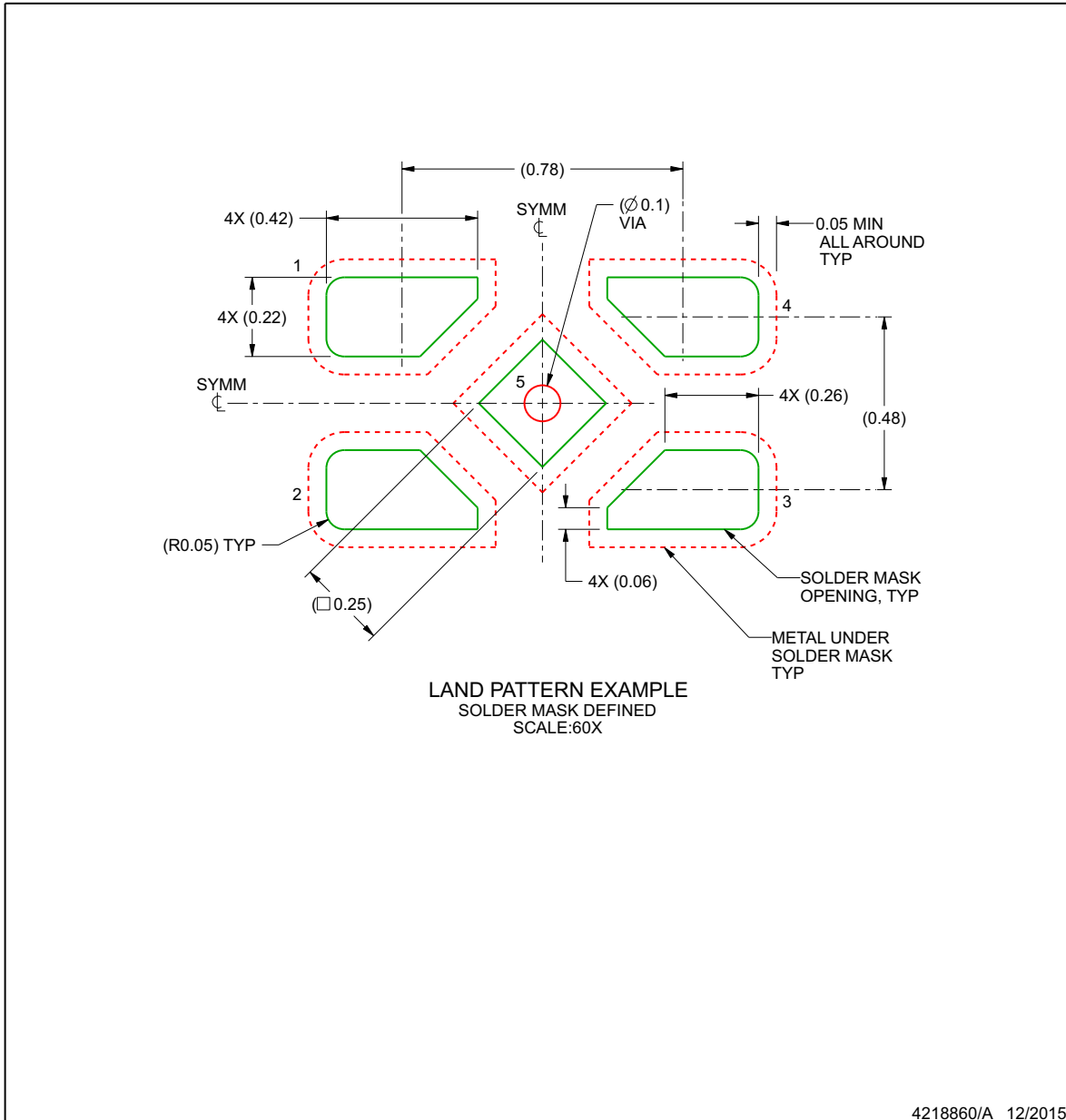

NOTES: (continued)

- 6. This package is designed to be soldered to a thermal pad on the board. For more information, see Texas Instruments literature number SLUA271 ([www.ti.com/lit/slua271](http://www.ti.com/lit/slua271)).
- 7. Vias are optional depending on application, refer to device data sheet. If some or all are implemented, recommended via locations are shown.

EXAMPLE STENCIL DESIGN

DPW0004A

X2SON - 0.4 mm max height

PLASTIC SMALL OUTLINE - NO LEAD

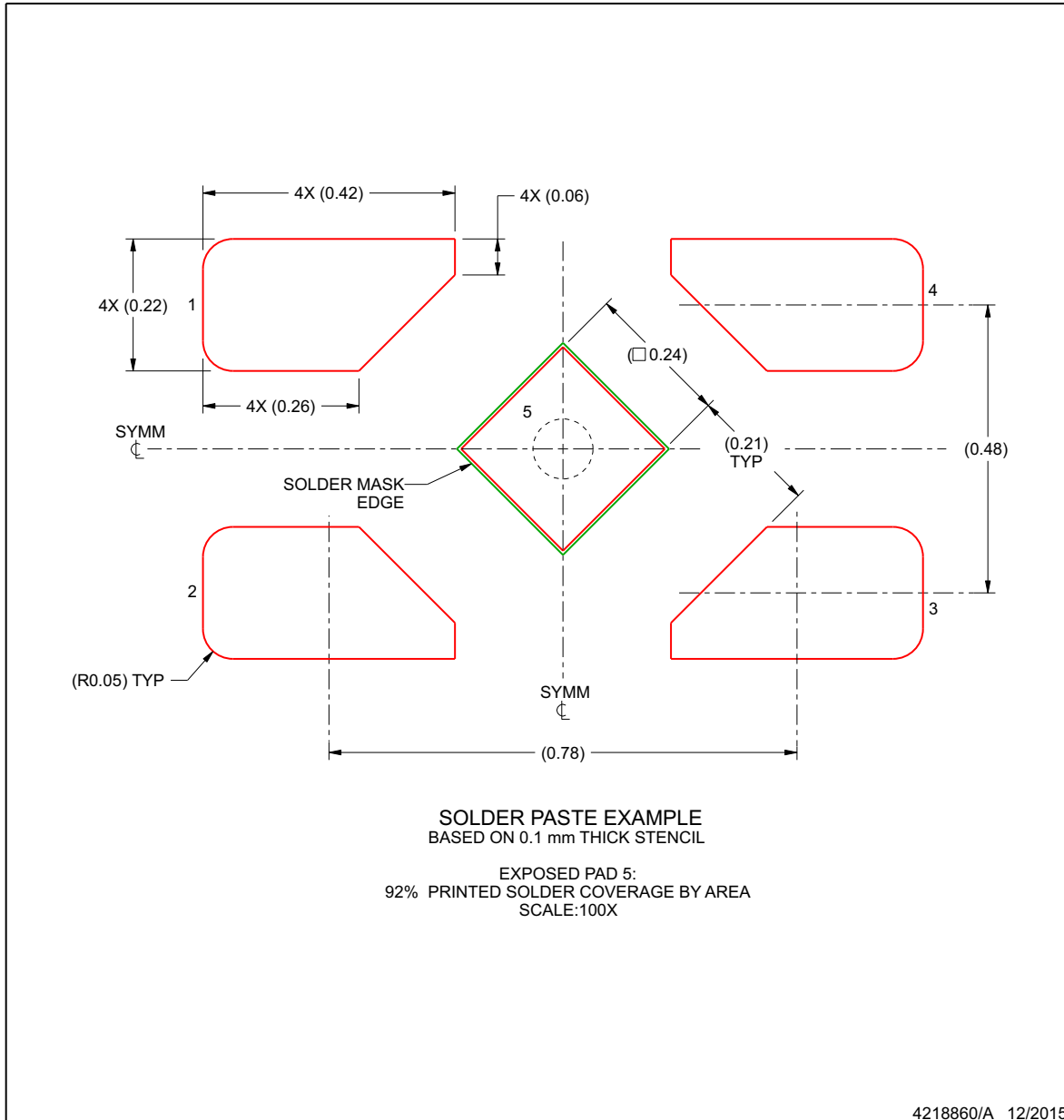

NOTES: (continued)

8. Laser cutting apertures with trapezoidal walls and rounded corners may offer better paste release. IPC-7525 may have alternate design recommendations.

**PACKAGING INFORMATION**

Orderable Device	Status (1)	Package Type	Package Drawing	Pins	Package Qty	Eco Plan (2)	Lead/Ball Finish (6)	MSL Peak Temp (3)	Op Temp (°C)	Device Marking (4/5)	Samples
TPD4E6B06DPWR	ACTIVE	X2SON	DPW	4	3000	Green (RoHS & no Sb/Br)	CU NIPDAU	Level-1-260C-UNLIM	-40 to 125	(B1 ~ B5)	<b>Samples</b>

(1) The marketing status values are defined as follows:

**ACTIVE:** Product device recommended for new designs.

**LIFEBUY:** TI has announced that the device will be discontinued, and a lifetime-buy period is in effect.

**NRND:** Not recommended for new designs. Device is in production to support existing customers, but TI does not recommend using this part in a new design.

**PREVIEW:** Device has been announced but is not in production. Samples may or may not be available.

**OBSELETE:** TI has discontinued the production of the device.

(2) Eco Plan - The planned eco-friendly classification: Pb-Free (RoHS), Pb-Free (RoHS Exempt), or Green (RoHS & no Sb/Br) - please check <http://www.ti.com/productcontent> for the latest availability information and additional product content details.

**TBD:** The Pb-Free/Green conversion plan has not been defined.

**Pb-Free (RoHS):** TI's terms "Lead-Free" or "Pb-Free" mean semiconductor products that are compatible with the current RoHS requirements for all 6 substances, including the requirement that lead not exceed 0.1% by weight in homogeneous materials. Where designed to be soldered at high temperatures, TI Pb-Free products are suitable for use in specified lead-free processes.

**Pb-Free (RoHS Exempt):** This component has a RoHS exemption for either 1) lead-based flip-chip solder bumps used between the die and package, or 2) lead-based die adhesive used between the die and leadframe. The component is otherwise considered Pb-Free (RoHS compatible) as defined above.

**Green (RoHS & no Sb/Br):** TI defines "Green" to mean Pb-Free (RoHS compatible), and free of Bromine (Br) and Antimony (Sb) based flame retardants (Br or Sb do not exceed 0.1% by weight in homogeneous material)

(3) MSL, Peak Temp. - The Moisture Sensitivity Level rating according to the JEDEC industry standard classifications, and peak solder temperature.

(4) There may be additional marking, which relates to the logo, the lot trace code information, or the environmental category on the device.

(5) Multiple Device Markings will be inside parentheses. Only one Device Marking contained in parentheses and separated by a "~" will appear on a device. If a line is indented then it is a continuation of the previous line and the two combined represent the entire Device Marking for that device.

(6) Lead/Ball Finish - Orderable Devices may have multiple material finish options. Finish options are separated by a vertical ruled line. Lead/Ball Finish values may wrap to two lines if the finish value exceeds the maximum column width.

**Important Information and Disclaimer:**The information provided on this page represents TI's knowledge and belief as of the date that it is provided. TI bases its knowledge and belief on information provided by third parties, and makes no representation or warranty as to the accuracy of such information. Efforts are underway to better integrate information from third parties. TI has taken and continues to take reasonable steps to provide representative and accurate information but may not have conducted destructive testing or chemical analysis on incoming materials and chemicals. TI and TI suppliers consider certain information to be proprietary, and thus CAS numbers and other limited information may not be available for release.

In no event shall TI's liability arising out of such information exceed the total purchase price of the TI part(s) at issue in this document sold by TI to Customer on an annual basis.



**TAPE AND REEL INFORMATION**

**QUADRANT ASSIGNMENTS FOR PIN 1 ORIENTATION IN TAPE**

\*All dimensions are nominal

Device	Package Type	Package Drawing	Pins	SPQ	Reel Diameter (mm)	Reel Width W1 (mm)	A0 (mm)	B0 (mm)	K0 (mm)	P1 (mm)	W (mm)	Pin1 Quadrant
TPD4E6B06DPWR	X2SON	DPW	4	3000	180.0	9.5	0.94	0.94	0.5	2.0	8.0	Q1

**TAPE AND REEL BOX DIMENSIONS**



\*All dimensions are nominal

Device	Package Type	Package Drawing	Pins	SPQ	Length (mm)	Width (mm)	Height (mm)
TPD4E6B06DPWR	X2SON	DPW	4	3000	184.0	184.0	19.0

## GENERIC PACKAGE VIEW

DPW 4

X2SON - 0.4 mm max height

PLASTIC SMALL OUTLINE - NO LEAD



Images above are just a representation of the package family, actual package may vary.  
Refer to the product data sheet for package details.

4211218-2/D



# EXAMPLE BOARD LAYOUT

DPW0004A

X2SON - 0.4 mm max height

PLASTIC SMALL OUTLINE - NO LEAD

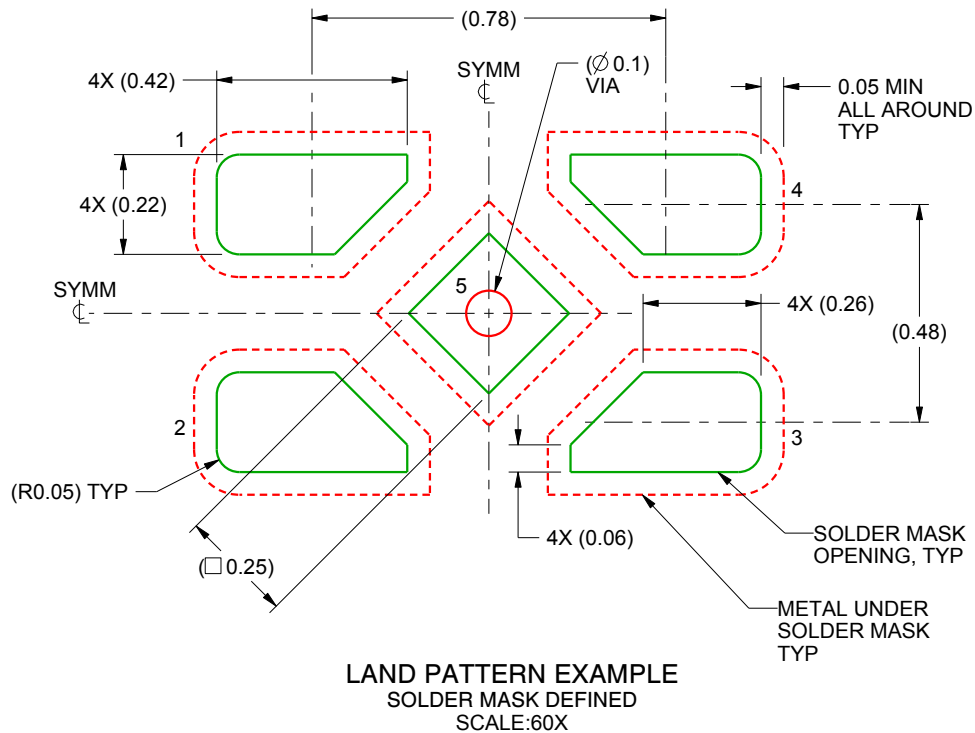

4218860/A 12/2015

NOTES: (continued)

6. This package is designed to be soldered to a thermal pad on the board. For more information, see Texas Instruments literature number SLUA271 ([www.ti.com/lit/slue271](http://www.ti.com/lit/slue271)).
7. Vias are optional depending on application, refer to device data sheet. If some or all are implemented, recommended via locations are shown.

# EXAMPLE STENCIL DESIGN

DPW0004A

X2SON - 0.4 mm max height

PLASTIC SMALL OUTLINE - NO LEAD

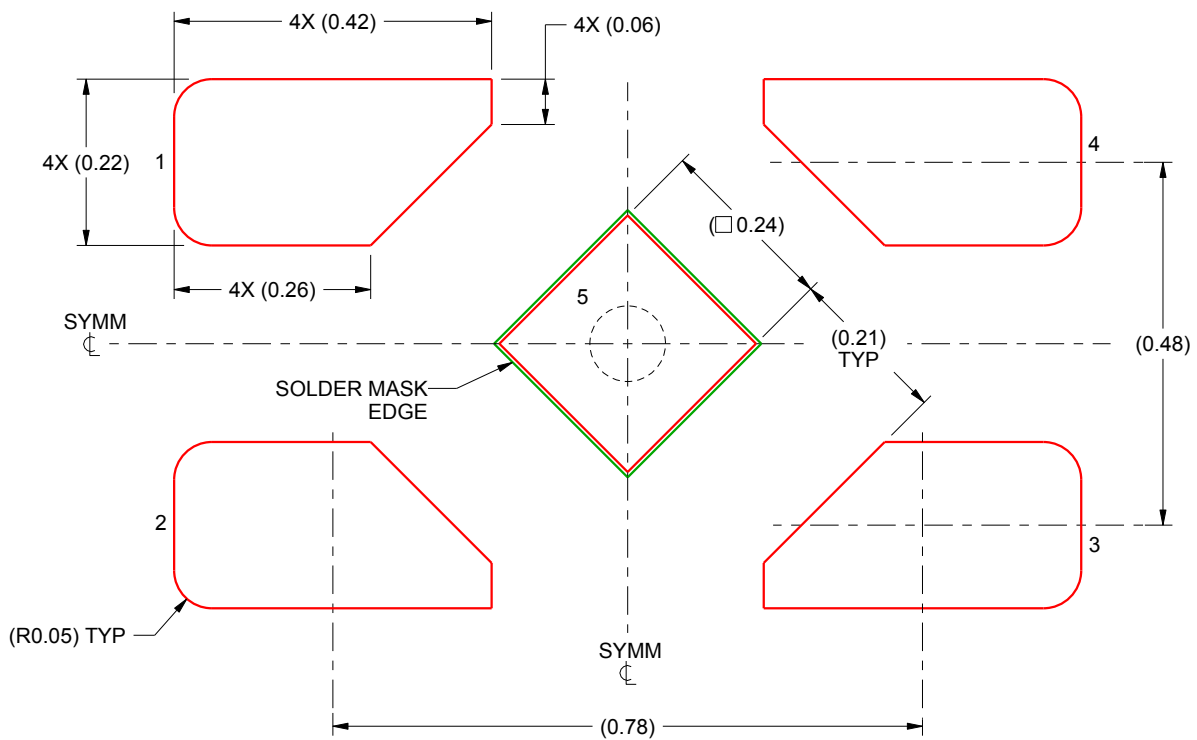

SOLDER PASTE EXAMPLE  
BASED ON 0.1 mm THICK STENCIL

EXPOSED PAD 5:  
92% PRINTED SOLDER COVERAGE BY AREA  
SCALE:100X

4218860/A 12/2015

NOTES: (continued)

8. Laser cutting apertures with trapezoidal walls and rounded corners may offer better paste release. IPC-7525 may have alternate design recommendations.

## IMPORTANT NOTICE AND DISCLAIMER

TI PROVIDES TECHNICAL AND RELIABILITY DATA (INCLUDING DATASHEETS), DESIGN RESOURCES (INCLUDING REFERENCE DESIGNS), APPLICATION OR OTHER DESIGN ADVICE, WEB TOOLS, SAFETY INFORMATION, AND OTHER RESOURCES "AS IS" AND WITH ALL FAULTS, AND DISCLAIMS ALL WARRANTIES, EXPRESS AND IMPLIED, INCLUDING WITHOUT LIMITATION ANY IMPLIED WARRANTIES OF MERCHANTABILITY, FITNESS FOR A PARTICULAR PURPOSE OR NON-INFRINGEMENT OF THIRD PARTY INTELLECTUAL PROPERTY RIGHTS.

These resources are intended for skilled developers designing with TI products. You are solely responsible for (1) selecting the appropriate TI products for your application, (2) designing, validating and testing your application, and (3) ensuring your application meets applicable standards, and any other safety, security, or other requirements. These resources are subject to change without notice. TI grants you permission to use these resources only for development of an application that uses the TI products described in the resource. Other reproduction and display of these resources is prohibited. No license is granted to any other TI intellectual property right or to any third party intellectual property right. TI disclaims responsibility for, and you will fully indemnify TI and its representatives against, any claims, damages, costs, losses, and liabilities arising out of your use of these resources.

TI's products are provided subject to TI's Terms of Sale ([www.ti.com/legal/termsofsale.html](http://www.ti.com/legal/termsofsale.html)) or other applicable terms available either on [ti.com](http://ti.com) or provided in conjunction with such TI products. TI's provision of these resources does not expand or otherwise alter TI's applicable warranties or warranty disclaimers for TI products.

Mailing Address: Texas Instruments, Post Office Box 655303, Dallas, Texas 75265  
Copyright © 2019, Texas Instruments Incorporated