

STRADA-2X2-FR

Asymmetric spotlight beam for floodlighting railway tracks according to Russian normative

TECHNICAL SPECIFICATIONS:

Dimensions	50.0 mm
Height	11.8 mm
Fastening	glue, pin, screw
ROHS compliant	yes ⓘ



MATERIAL SPECIFICATIONS:

Component	Type	Material	Colour	Finish
STRADA-2X2-FR	Multi-lens	PMMA	clear	

ORDERING INFORMATION:

Component	Qty in box	MOQ	MPQ	Box weight (kg)
C16378_STRADA-2X2-FR » Box size: 476 x 273 x 292 mm	800		160	11.7

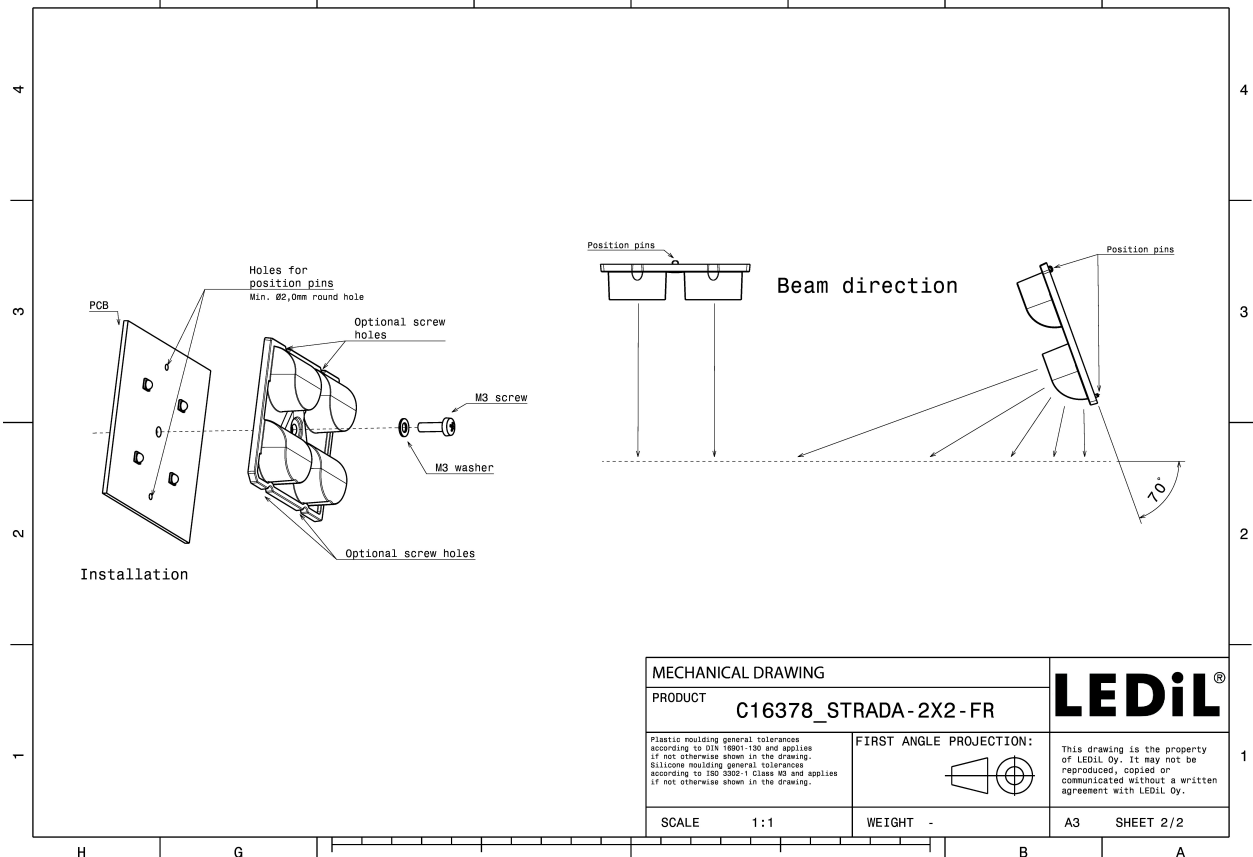
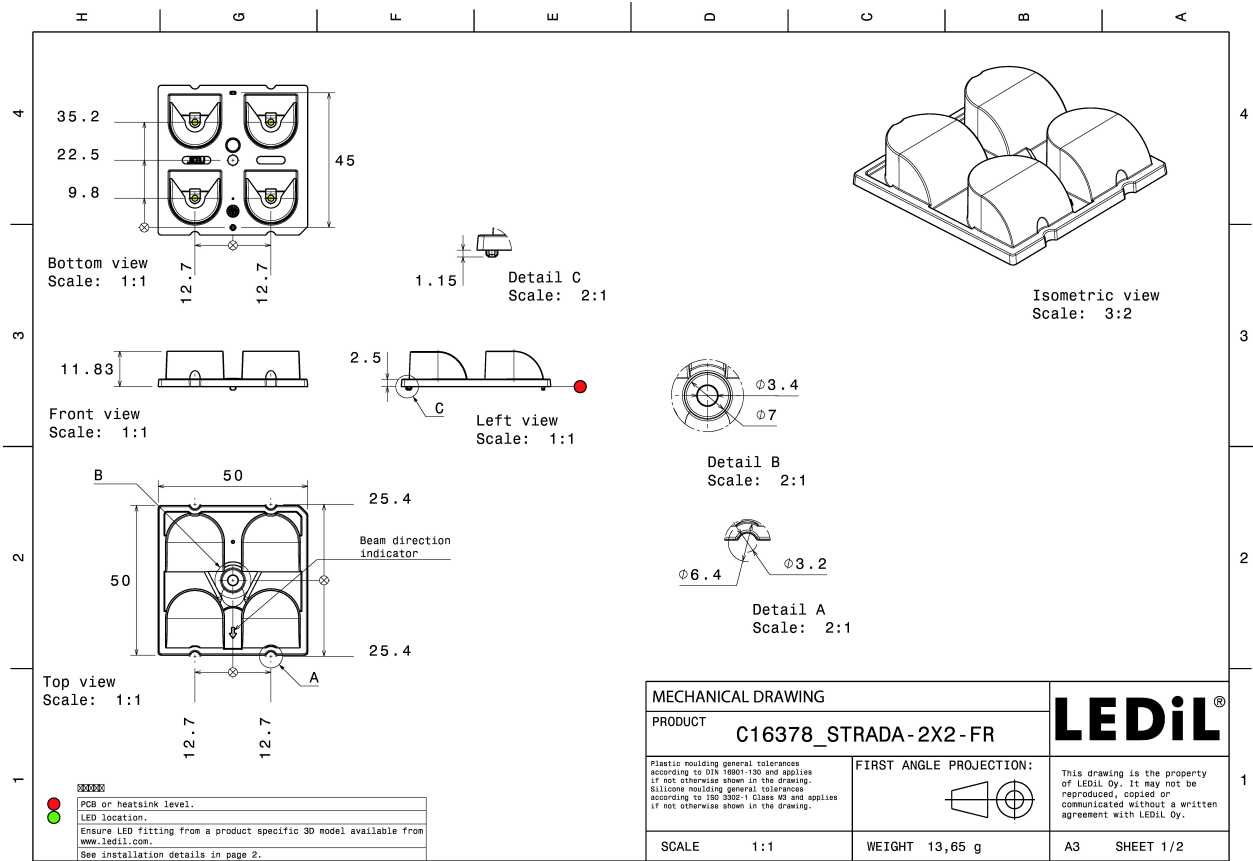

See also our general installation guide: www.ledil.com/installation_guide

PHOTOMETRIC DATA (MEASURED):

CREE

LED XP-G2
 FWHM 15.0 + 16.0°
 Efficiency 90 %
 Peak intensity 5.8 cd/lm
 LEDs/each optic 1
 Light colour White
 Required components:

Transparent protective cover

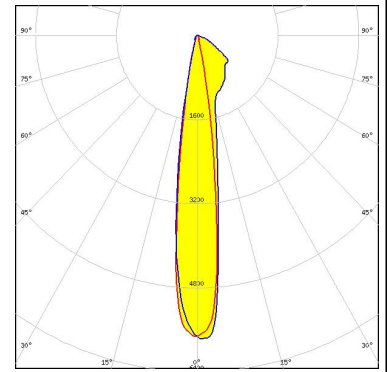

CREE

LED XP-G2
 FWHM 15.0 + 16.0°
 Efficiency 94 %
 Peak intensity 5.9 cd/lm
 LEDs/each optic 1
 Light colour White
 Required components:

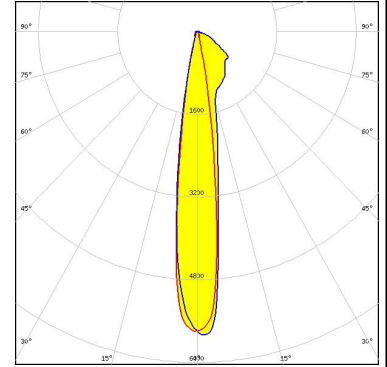

NICHIA

LED NVSW219F
 FWHM 18.0 + 20.0°
 Efficiency 94 %
 Peak intensity 4.4 cd/lm
 LEDs/each optic 1
 Light colour White
 Required components:

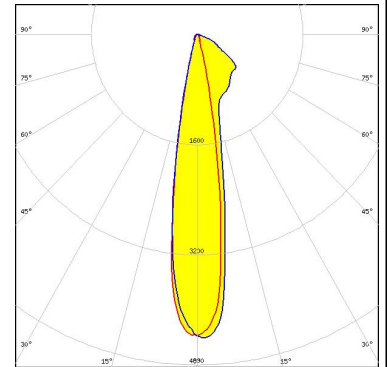

NICHIA

LED NVSW319B
 FWHM 20.0 + 22.0°
 Efficiency 94 %
 Peak intensity 3.9 cd/lm
 LEDs/each optic 1
 Light colour White
 Required components:

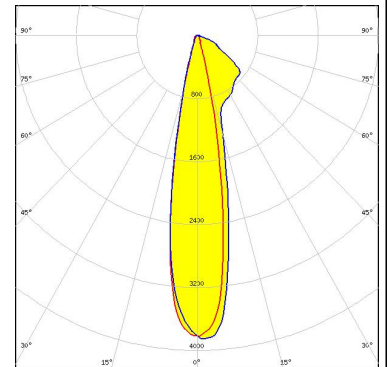

PHOTOMETRIC DATA (MEASURED):

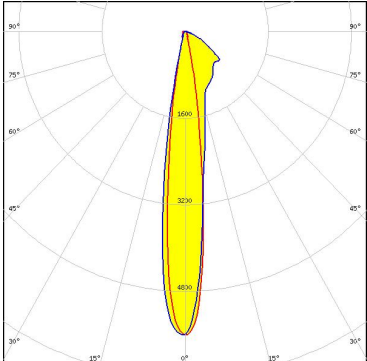
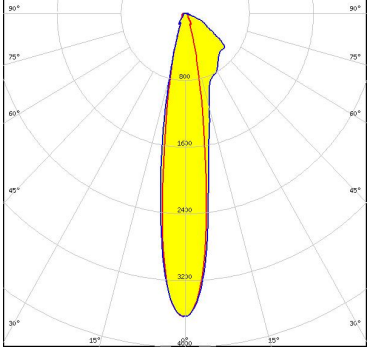
<p>OSRAM Opto Semiconductors</p> <p>LED OSOLON Square PC FWHM 14.0 + 15.0° Efficiency 94 % Peak intensity 5.6 cd/lm LEDs/each optic 1 Light colour White Required components:</p>	
<p>SEOUL SEOUL SEMICONDUCTOR</p> <p>LED Z5M3 FWHM Asymmetric Efficiency 94 % Peak intensity 3.6 cd/lm LEDs/each optic 1 Light colour White Required components:</p>	

PHOTOMETRIC DATA (SIMULATED):



LED XP-G2 HE
 FWHM 18.0 + 21.0°
 Efficiency 92 %
 Peak intensity 4.4 cd/lm
 LEDs/each optic 1
 Light colour White
 Required components:

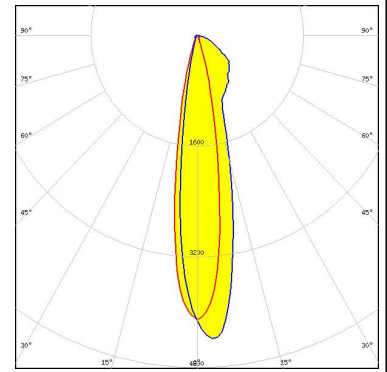

LED XP-G3
 FWHM Asymmetric
 Efficiency 85 %
 Peak intensity 4.2 cd/lm
 LEDs/each optic 1
 Light colour White
 Required components:

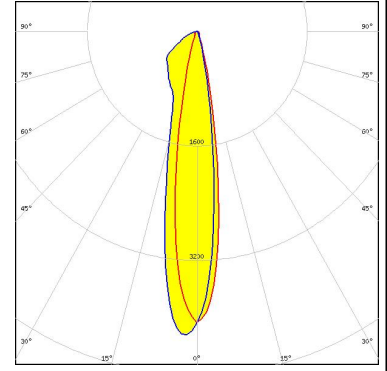

Transparent protective cover



LED XP-G3
 FWHM 17.0 + 18.0°
 Efficiency 92 %
 Peak intensity 4.8 cd/lm
 LEDs/each optic 1
 Light colour White
 Required components:

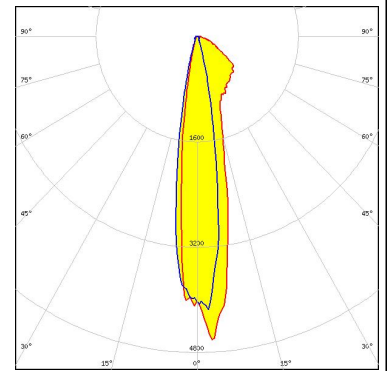

LED LUXEON TX
 FWHM 15.0 + 16.0°
 Efficiency 93 %
 Peak intensity 6.6 cd/lm
 LEDs/each optic 1
 Light colour White
 Required components:

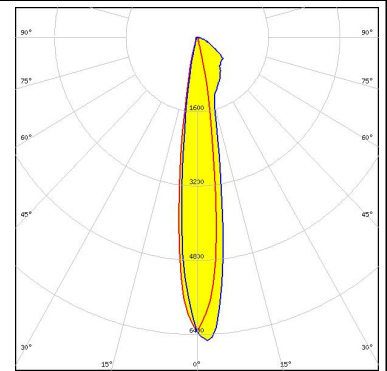

PHOTOMETRIC DATA (SIMULATED):

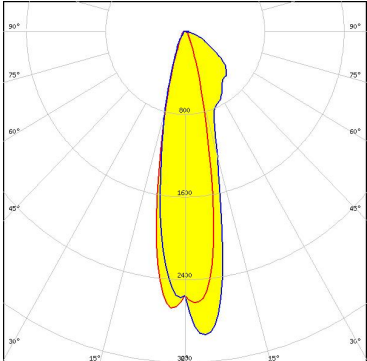
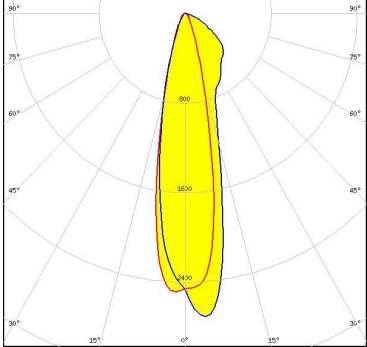
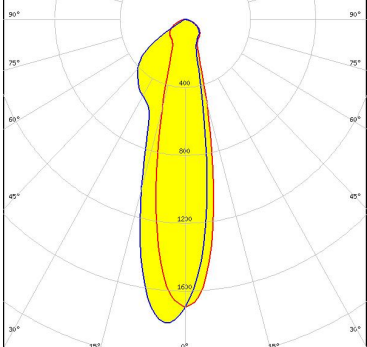
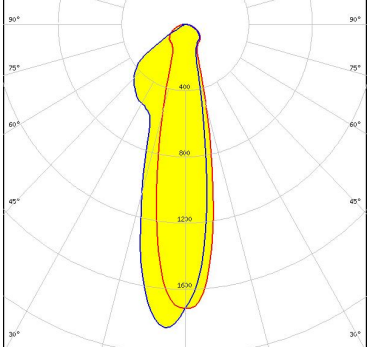
<p>NICHIA</p> <p>LED: NV4WB35AM FWHM: 22.0 + 24.0° Efficiency: 94 % Peak intensity: 3 cd/lm LEDs/each optic: 1 Light colour: White Required components:</p>	
<p>NICHIA</p> <p>LED: NV4WB35AM FWHM: Asymmetric Efficiency: 88 % Peak intensity: 2.7 cd/lm LEDs/each optic: 1 Light colour: White Required components:</p> <p>Transparent protective cover</p>	
<p>NICHIA</p> <p>LED: NVSW519A FWHM: 23.0 + 25.0° Efficiency: 88 % Peak intensity: 1.8 cd/lm LEDs/each optic: 1 Light colour: White Required components:</p> <p>Transparent protective cover</p>	
<p>NICHIA</p> <p>LED: NVSW519A FWHM: 23.0 + 24.0° Efficiency: 93 % Peak intensity: 1.8 cd/lm LEDs/each optic: 1 Light colour: White Required components:</p>	

PHOTOMETRIC DATA (SIMULATED):

<p>NICHIA</p> <p>LED: NVSxE21A FWHM: 12.0 + 13.0° Efficiency: 93 % Peak intensity: 7.6 cd/lm LEDs/each optic: 1 Light colour: White Required components:</p>	
<p>NICHIA</p> <p>LED: NWSx229A FWHM: 24.0 + 25.0° Efficiency: 93 % Peak intensity: 2.8 cd/lm LEDs/each optic: 1 Light colour: White Required components:</p>	
<p>OSRAM <small>Opto Semiconductors</small></p> <p>LED: OSCONIQ P 3737 (2W version) FWHM: 14.0° Efficiency: 93 % Peak intensity: 6.9 cd/lm LEDs/each optic: 1 Light colour: White Required components:</p>	
<p>OSRAM <small>Opto Semiconductors</small></p> <p>LED: OSCONIQ P 3737 (3W version) FWHM: 20.0 + 22.0° Efficiency: 94 % Peak intensity: 3.8 cd/lm LEDs/each optic: 1 Light colour: White Required components:</p>	

PHOTOMETRIC DATA (SIMULATED):

OSRAM

Opto Semiconductors

LED OSLO Square CSSRM2/CSSRM3
 FWHM 13.0 + 14.0°
 Efficiency 86 %
 Peak intensity 6.6 cd/lm
 LEDs/each optic 1
 Light colour White
 Required components:

Transparent protective cover

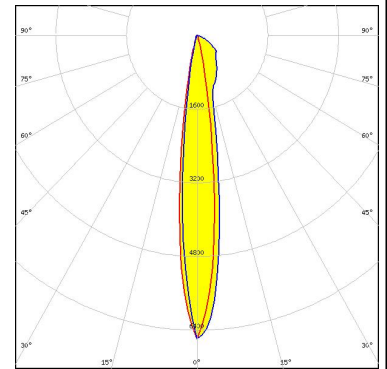

OSRAM

Opto Semiconductors

LED OSLO Square CSSRM2/CSSRM3
 FWHM 13.0 + 14.0°
 Efficiency 93 %
 Peak intensity 6.9 cd/lm
 LEDs/each optic 1
 Light colour White
 Required components:

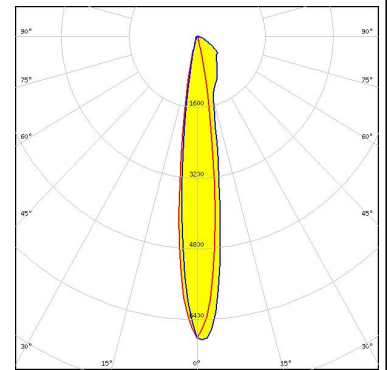

SAMSUNG

LED LH351B
 FWHM 18.0 + 19.0°
 Efficiency 94 %
 Peak intensity 5 cd/lm
 LEDs/each optic 1
 Light colour White
 Required components:

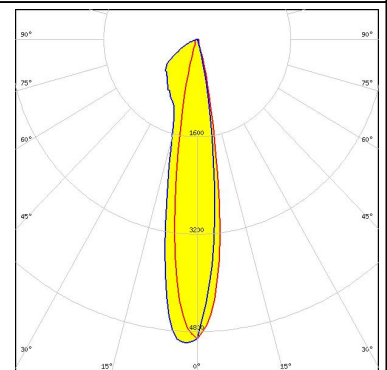

SAMSUNG

LED LH351C
 FWHM 18.0 + 20.0°
 Efficiency 94 %
 Peak intensity 4.6 cd/lm
 LEDs/each optic 1
 Light colour White
 Required components:

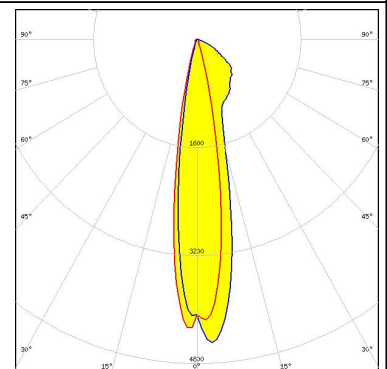

PHOTOMETRIC DATA (SIMULATED):

SAMSUNG

LED	LH351D
FWHM	22.0 + 26.0°
Efficiency	94 %
Peak intensity	3 cd/lm
LEDs/each optic	1
Light colour	White
Required components:	

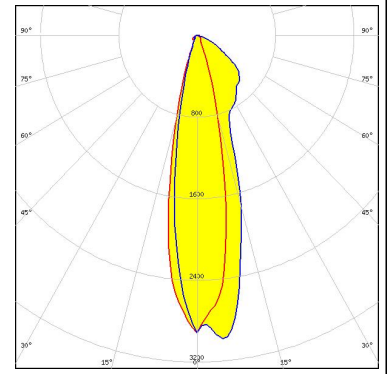

GENERAL INFORMATION:

NOTE: The typical beam angle will be changed by different color, chip size and chip position tolerance. The typical total beam angle is the full angle measured where the luminous intensity is half of the peak value.

MATERIALS:

As part of our continuous research and improvement processes, and to ensure the best possible quality and availability of our products, LEDiL reserves the right to change material grades without notice.

PRODUCT DATA USER AGREEMENT AND DISCLAIMER:

The measured data in the provided downloadable LEDiL Product Datasheets and Mechanical 2D-Drawings is rounded and provided as reference for planning. LEDiL Oy's optical specifications have been verified by conducting performance testing of the products in accordance with the company's quality system. The reported data are averaged results of multiple measurements with typical variation. LEDiL Oy reserves the right to without prior notification make changes and improvements to its products.

LEDiL Oy assumes neither warranty, nor guarantee nor any other liability of any kind for the contents and correctness of the provided data. The provided data has been generated with highest diligence but the provided data may in reality not represent the complete possible variation range of all intrinsic parameters. Therefore, in certain cases a deviation from the provided data could occur.

LEDiL Oy reserves the right to undertake technical changes of its products without further notification which could lead to changes in the provided data. LEDiL Oy assumes no liability of any kind for the possible deviation from any provided data or any other damage resulting from the usage of the provided data.

The user agrees to this disclaimer and user agreement with the download or usage of the provided files.

LEDiL Oy

Joensuunkatu 13
FI-24240 SALO
Finland

LEDiL Inc.

228 West Page Street
Suite D
Sycamore IL 60178
USA

Ledil Optics Technology (Shenzhen) Co., Ltd.

405 , Block B
Casic Motor Building
Shenzhen 518057
P.R.CHINA

Local sales and technical support

[www.ledil.com/
where_to_buy](http://www.ledil.com/where_to_buy)

Shipping locations

Salo, Finland
Hong Kong, China

Distribution Partners

[www.ledil.com/
where_to_buy](http://www.ledil.com/where_to_buy)