

SuperESD - ESD5302F-ES

1. Description

The ESD5302F-ES is an ultra-low capacitance TVS (Transient Voltage Suppressor) array designed to protect high speed data interfaces. It has been specifically designed to protect sensitive electronic components which are connected to data and transmission lines from over-stress caused by ESD (Electrostatic Discharge).

2. Features

- IEC 61000-4-2 Level 4 ESD Protection
 - ±18kV Contact Discharge
 - ±18kV Air Discharge
- 60W Peak pulse Power (8/20us)
- Low leakage current
- Working voltage: 5V
- RoHS compliant
- Protecting two unidirectional lines
- Low clamping voltage

3. Applications

- Portable electronics
- USB 2.0 and USB 3.0
- HDMI 1.3 and HDMI 1.4
- SATA and eSATA
- DVI
- IEEE 1394
- PCI Express
- Notebooks

4. Ordering Information

Part Number	Package	Marking	Material	Packing	Quantity per reel	Flammability Rating	Reel Size
ESD5302F-ES	SOT-23	R22	Halogen free	Tape & Reel	3,000 PCS	UL 94V-0	7 inches

Table-1 Ordering information

5. Pin Configuration and Functions

Pin	Name	Description	Outline	Circuit Diagram
1	IO	Connect to IO		
2	IO	Connect to IO		
3	GND	Connect to GND		

Table-2 Pin configuration

6. Specification

6.1. Absolute Maximum rating

Over operating free-air temperature range (unless otherwise noted)

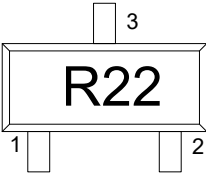
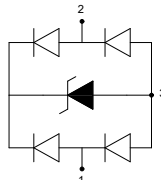
Parameters	Symbol	Min.	Max.	Unit
Peak pulse power (tp=8/20us)@25°C	P _{pk}	-	60	W
Peak pulse current (tp=8/20us)@25°C	I _{PP}	-	4	A
ESD (IEC61000-4-2 air discharge) @25°C	V _{ESD}	-	±18	kV
ESD (IEC61000-4-2 contact discharge) @25°C	V _{ESD}	-	±18	kV
Junction temperature	T _J	-	150	°C
Operating temperature	T _{OP}	-40	125	°C
Storage temperature	T _{STG}	-55	150	°C
Lead temperature	T _L	-	260	°C

Table-3 Absolute Maximum rating

6.2. Electrical Characteristics

At TA = 25°C unless otherwise noted

Parameter	Symbol	Conditions	Min.	Typ.	Max.	Units
Reverse Stand-off Voltage	V_{RWM}				5.0	V
Reverse Breakdown Voltage	V_{BR}	$I_T=1mA$	6.0		9.0	V
Reverse Leakage Current	I_R	$V_{RWM}=5V$			1.0	μA
Clamping Voltage	V_C	$I_{PP}=1A$; $t_p=8/20\mu s$		8.0	10.0	V
Clamping Voltage	V_C	$I_{PP}=4A$; $t_p=8/20\mu s$		11.0	13.0	V
Junction Capacitance	C_J	$V_R=0V$; $f=1MHz$		0.6	0.8	pF

Table-4 Electrical Characteristics

Symbol	Parameters
V_{RWM}	Peak Reverse Working Voltage
I_R	Reverse Leakage Current @ V_{RWM}
V_{BR}	Breakdown Voltage @ I_T
I_T	Test Current
I_{PP}	Maximum Reverse Peak Pulse Current
V_C	Clamping Voltage @ I_{PP}
I_F	Forward Current
V_F	Forward Voltage @ I_F

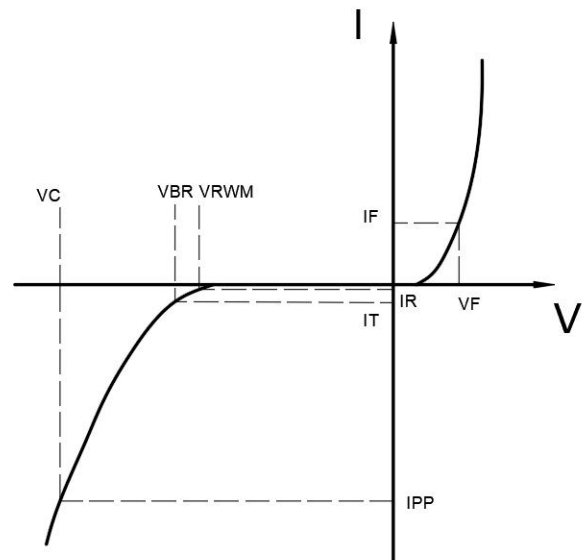

7. Typical Characteristic

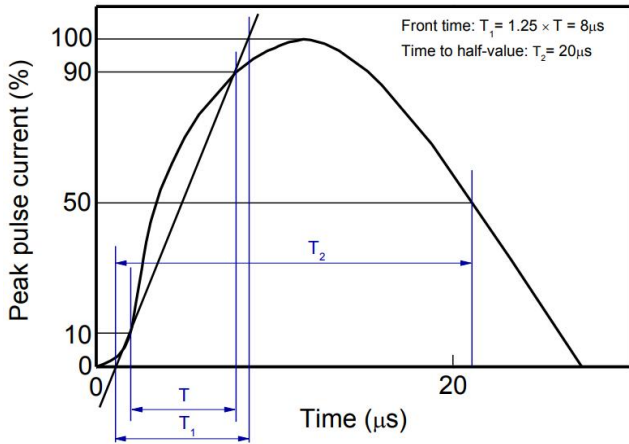

8/20μs waveform per IEC61000-4-5

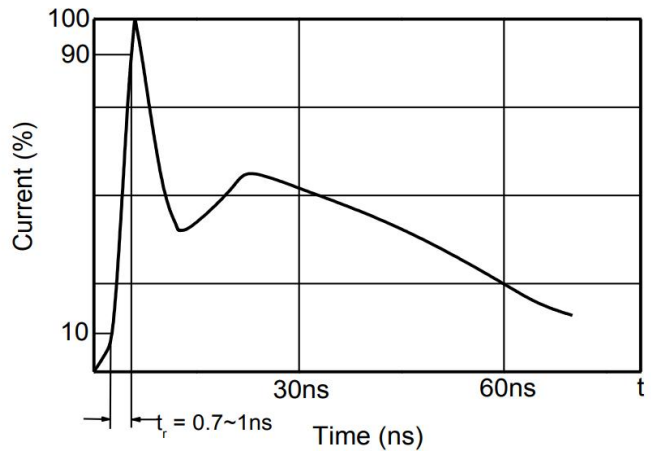

Contact discharge current waveform per IEC61000-4-2

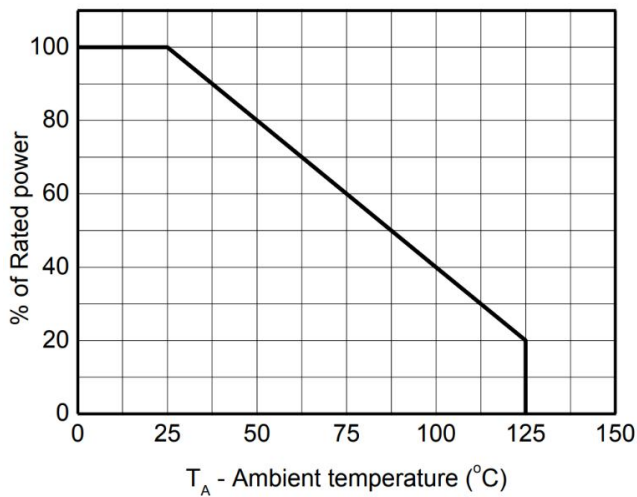

Power derating vs. Ambient temperature

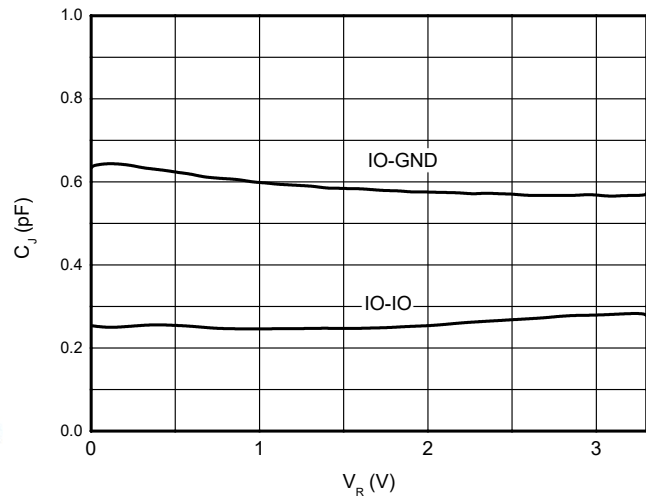

Capacitance vs. Reverse voltage

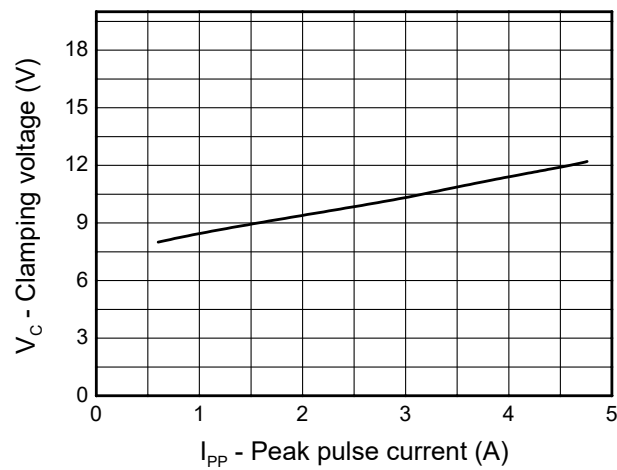

Clamping voltage vs. Peak pulse current

8. Dimension (SOT-23)

POD(Z)

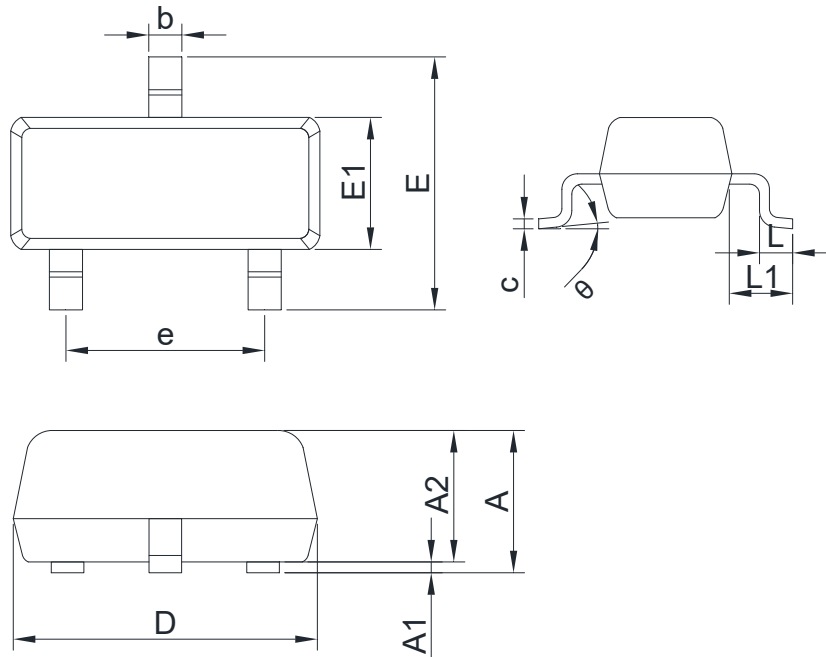

COMMON DIMENSIONS CUNITS MEASURE=MILLIMETER					
SYMBOL	MIN	MAX	SYMBOL	MIN	MAX
A	0.90	1.20	E	2.25	2.55
A1	0.00	0.10	E1	1.20	1.40
A2	0.90	1.10	e	1.80	2.00
b	0.30	0.50	L	0.30	0.50
c	0.07	0.18	L1	0.475	0.625
D	2.80	3.04	theta	0°	8°

9. Recommended Soldering Footprint

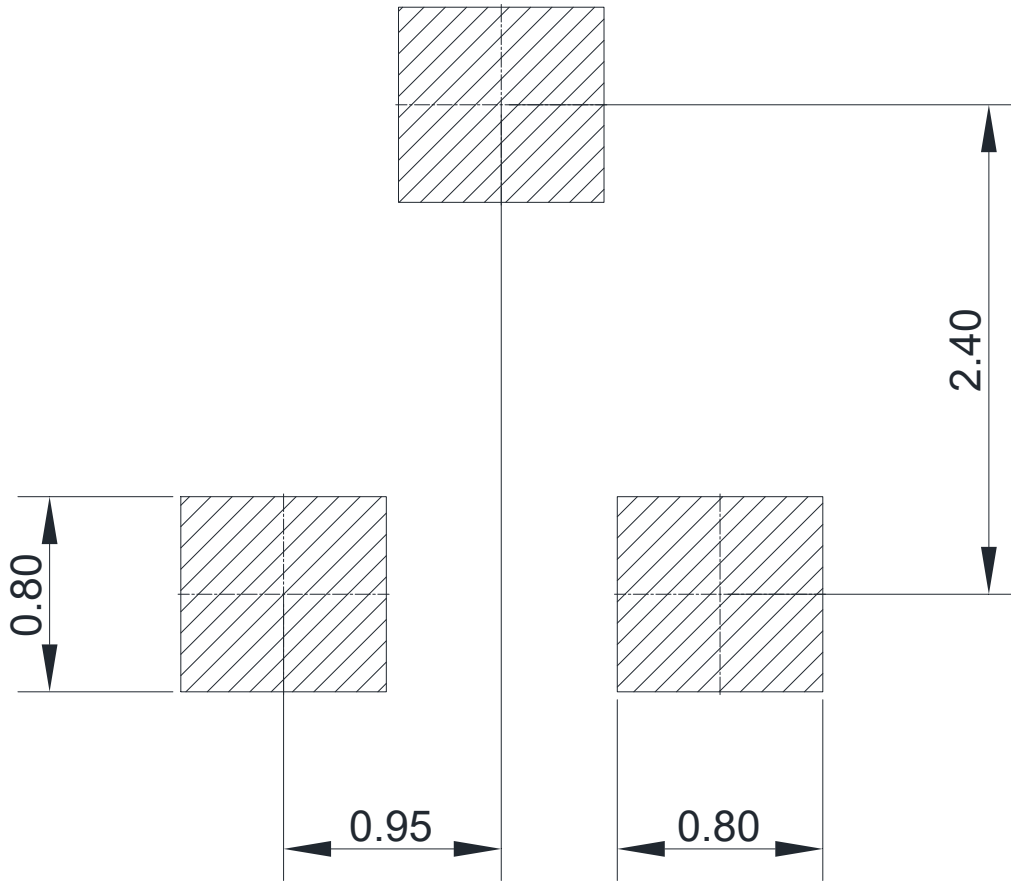

DIMENSIONS: MILLIMETERS

DISCLAIMER

ELECSUPER PROVIDES TECHNICAL AND RELIABILITY DATA (INCLUDING DATASHEETS), DESIGN RESOURCES (INCLUDING REFERENCE DESIGNS), APPLICATION OR OTHER DESIGN ADVICE, SAFETY INFORMATION, AND OTHER RESOURCES "AS IS" AND WITH ALL FAULTS, AND DISCLAIMS ALL WARRANTIES, EXPRESS AND IMPLIED, INCLUDING WITHOUT LIMITATION ANY IMPLIED WARRANTIES OF MERCHANTABILITY, FITNESS FOR A PARTICULAR PURPOSE OR NON-INFRINGEMENT OF THIRD PARTY INTELLECTUAL PROPERTY RIGHTS.

These resources are intended for skilled developers designing with ElecSuper products. You are solely responsible for

- (1) selecting the appropriate ElecSuper products for your application;
- (2) designing, validating and testing your application;
- (3) ensuring your application meets applicable standards, and any other safety, security, or other requirements.

These resources are subject to change without notice. ElecSuper grants you permission to use these resources only for development of an application that uses the ElecSuper products described in the resource. Other reproduction and display of these resources are prohibited. No license is granted to any other ElecSuper intellectual property right or to any third party intellectual property right. ElecSuper disclaims responsibility for, and you will fully indemnify ElecSuper and its representatives against, any claims, damages, costs, losses, and liabilities arising out of your use of these resources. ElecSuper's products are provided subject to ElecSuper's Terms of Sale or other applicable terms available either on www.elecsuper.com or provided in conjunction with such ElecSuper products. ElecSuper's provision of these resources does not expand or otherwise alter ElecSuper's applicable warranties or warranty disclaimers for ElecSuper products.