



SPC5 Development Ecosystem

ZHANG Livia

Senior Application Engineer, Micro BU
ADG Marketing and Application
Greater China & South Asia Region
STMicroelectronics



2017年ST汽车MCU技术日
2017年6月6日，上海
2017年6月8日，深圳
2017年6月13日，北京

SPC5 Ecosystem

2

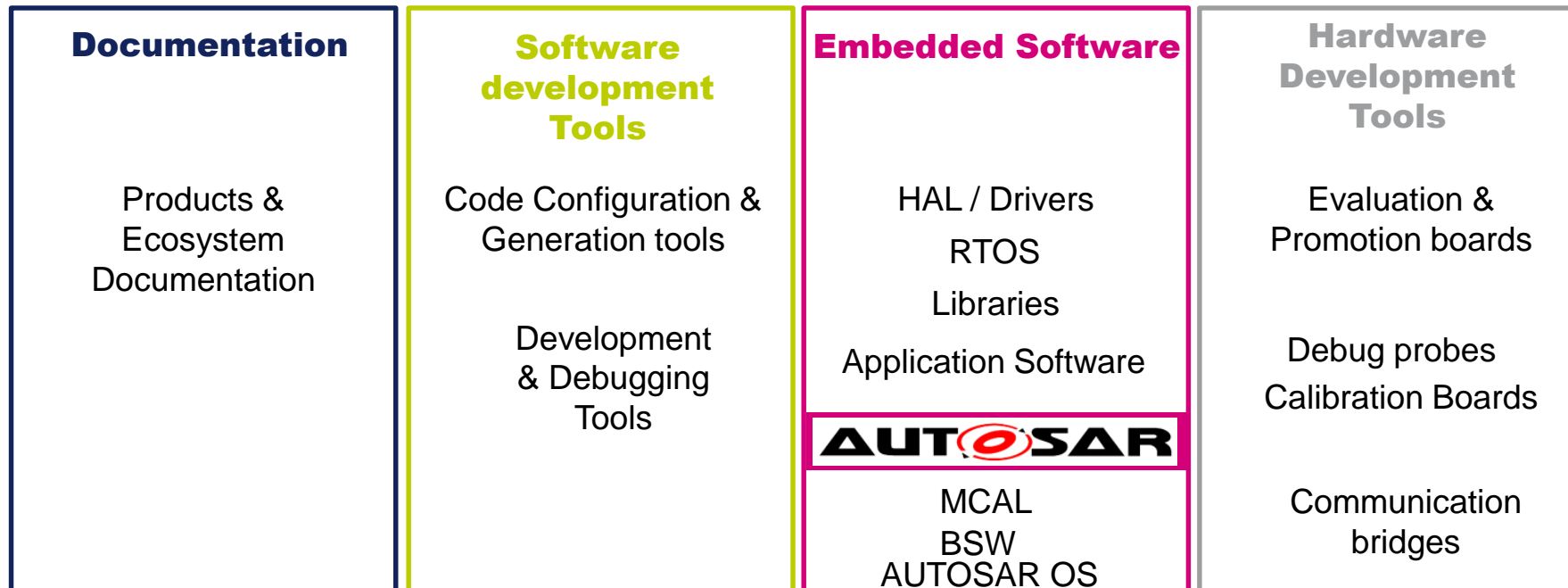

life.augmented

Software & development tools

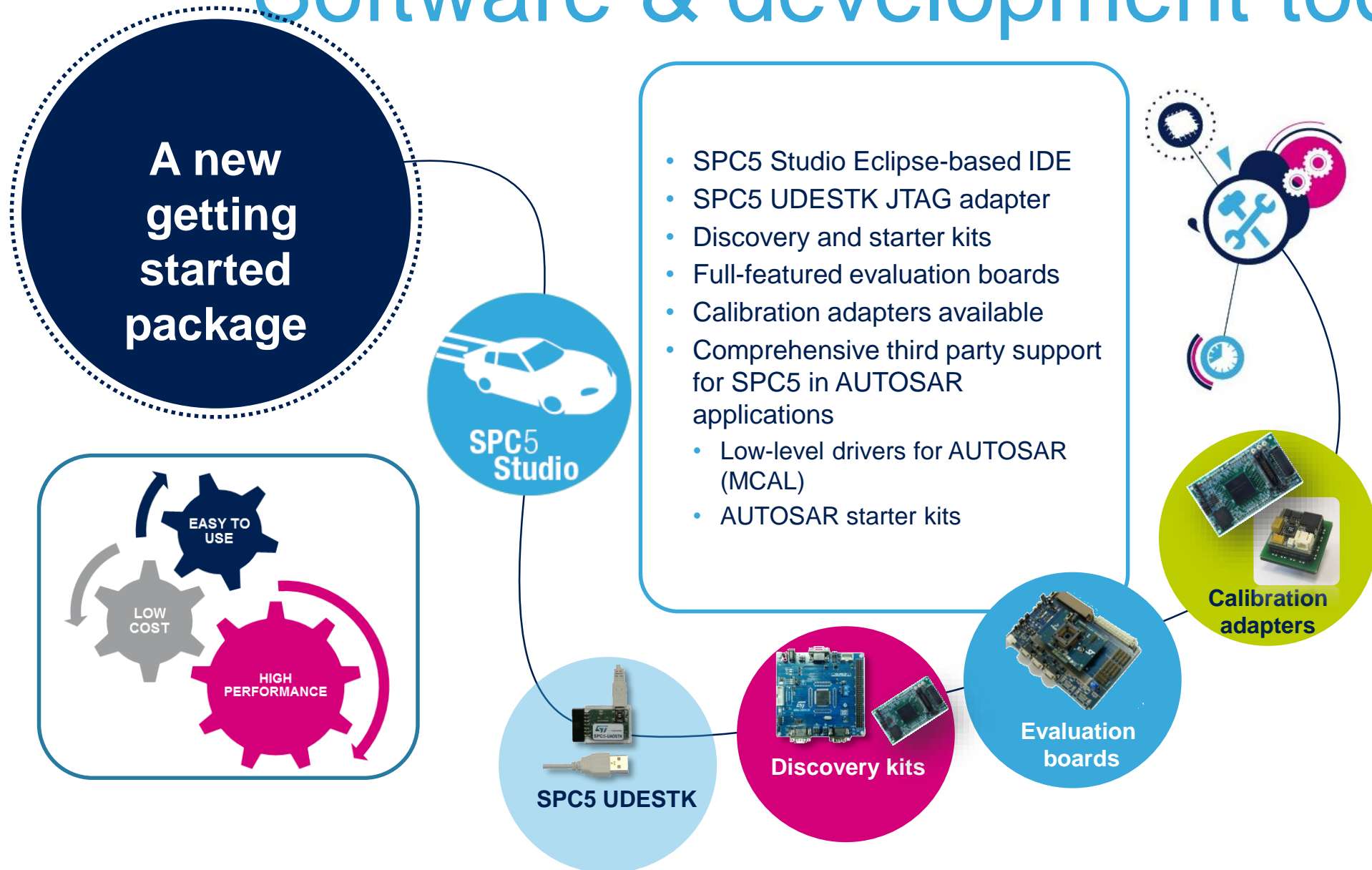

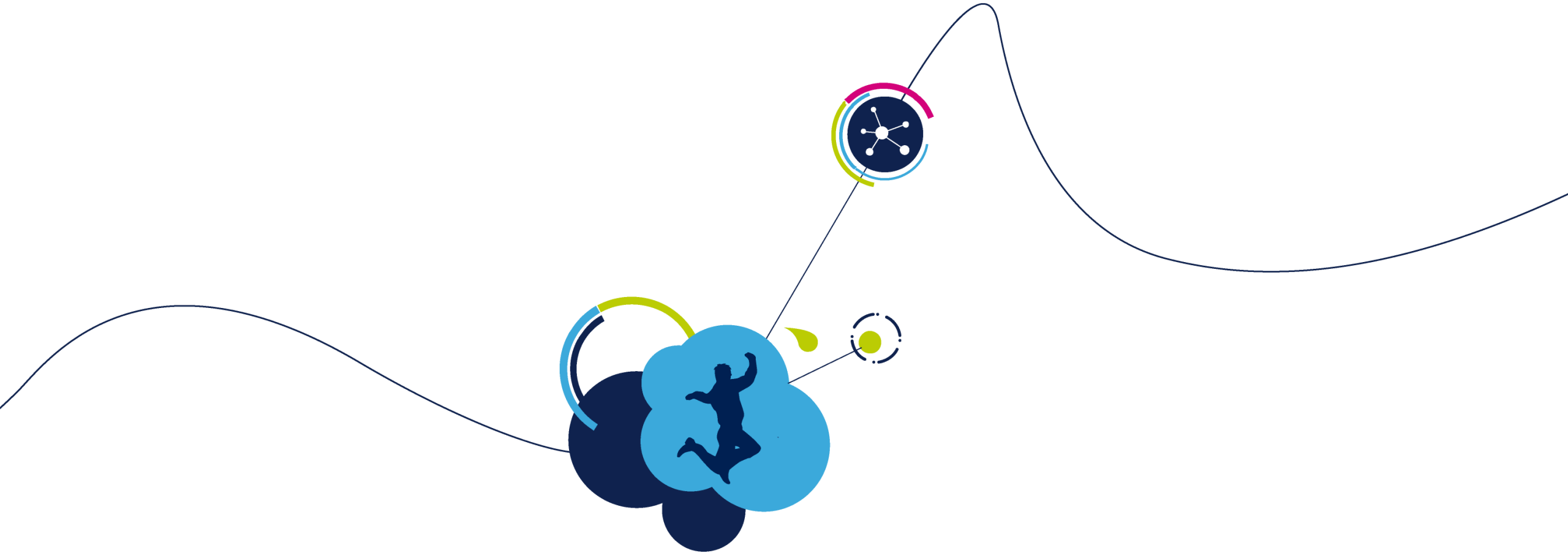

SPC5Studio IDE



life.augmented

SPC5Studio Development Framework



- Eclipse Based Open Framework
- Quick Application Development
- Easy to Get Started
- Easy to Use
- Free on www.st.com

Save more than **80%** time resources

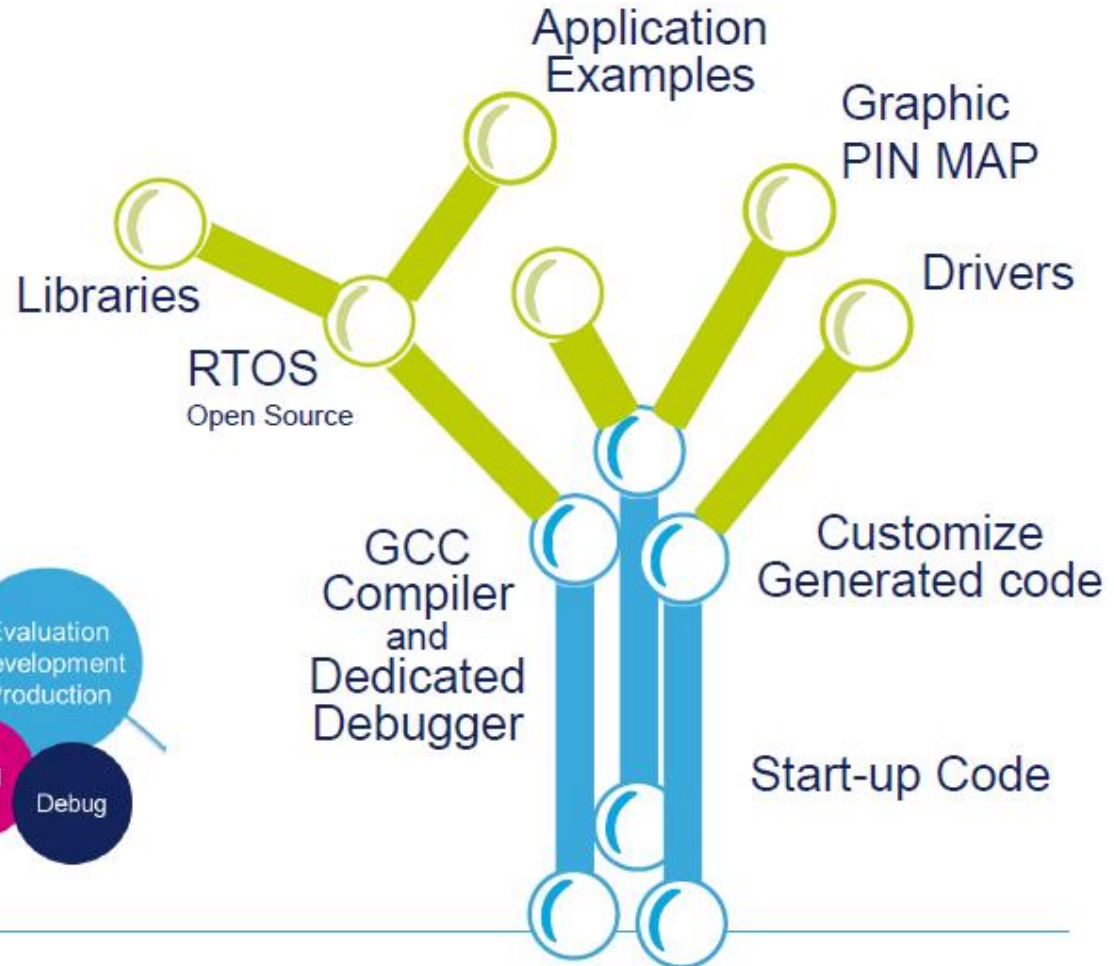

life.augmented



SPC56 Family support

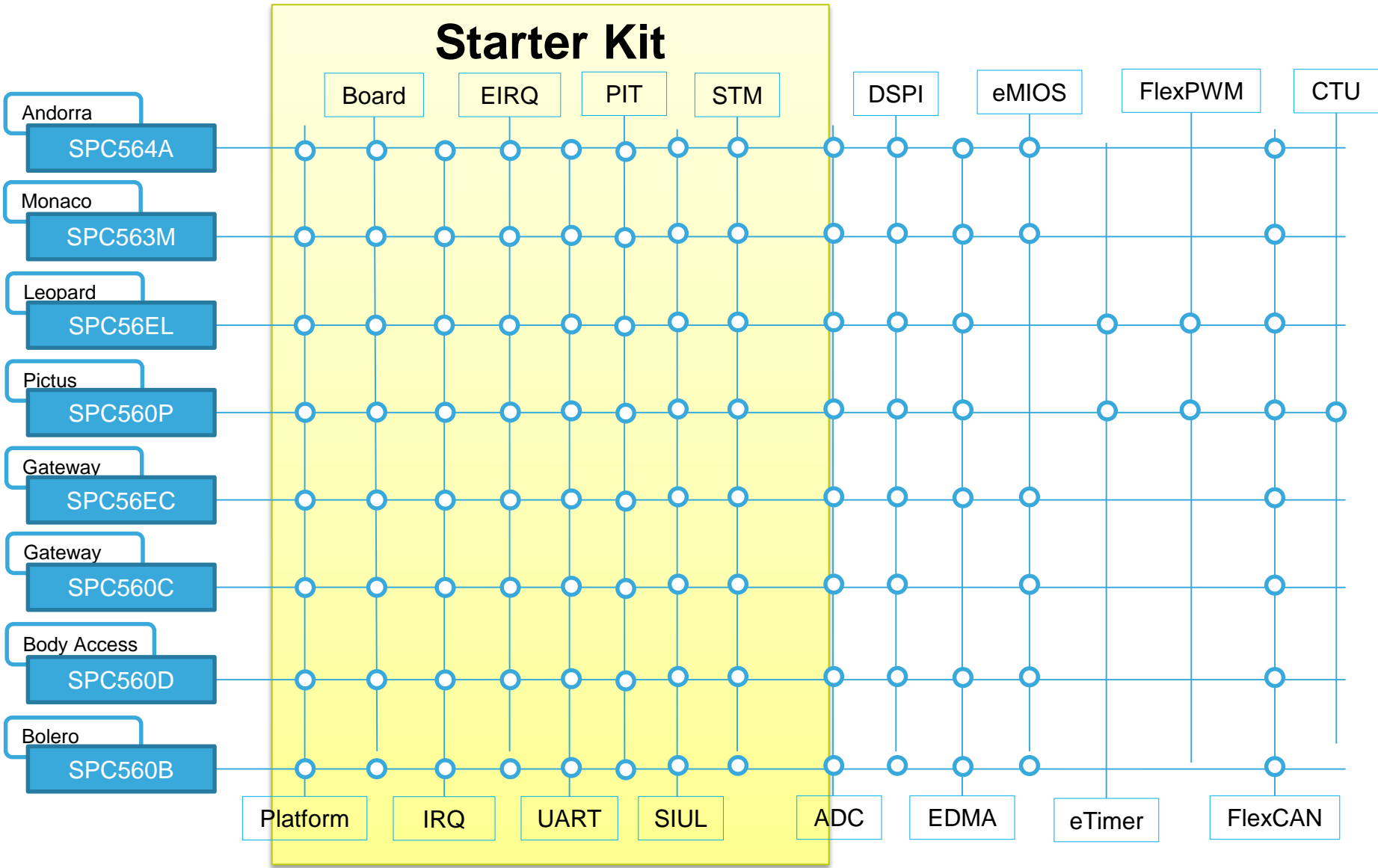

*SPC5Studio V5.3





SPC57 Family support 7

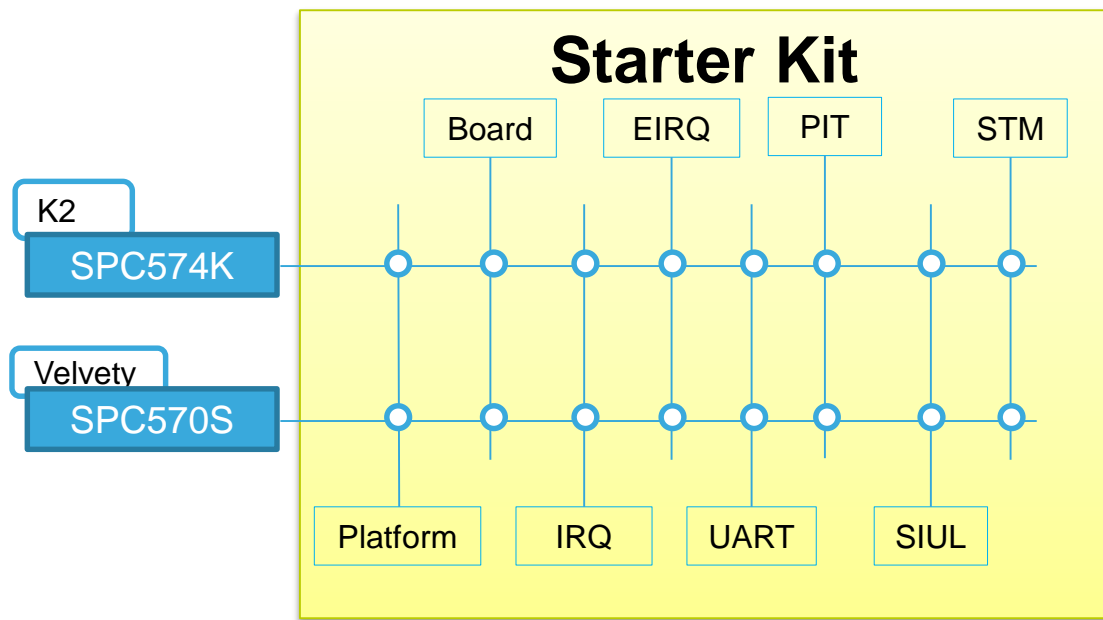

- *Starter Kit* available for
 - K2
 - Velvety
- K2 Multicore:
 - boot support
 - application framework



*SPC5Studio V5.3



SPC58 Family support 8

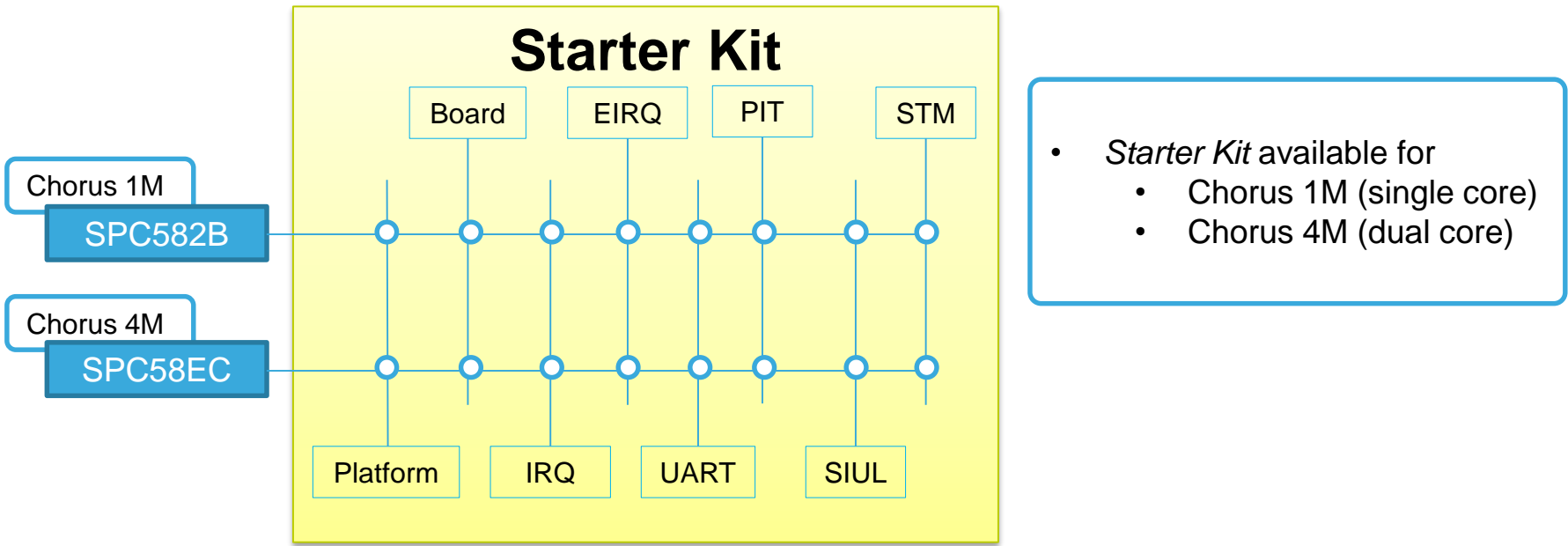

*SPC5Studio V5.3

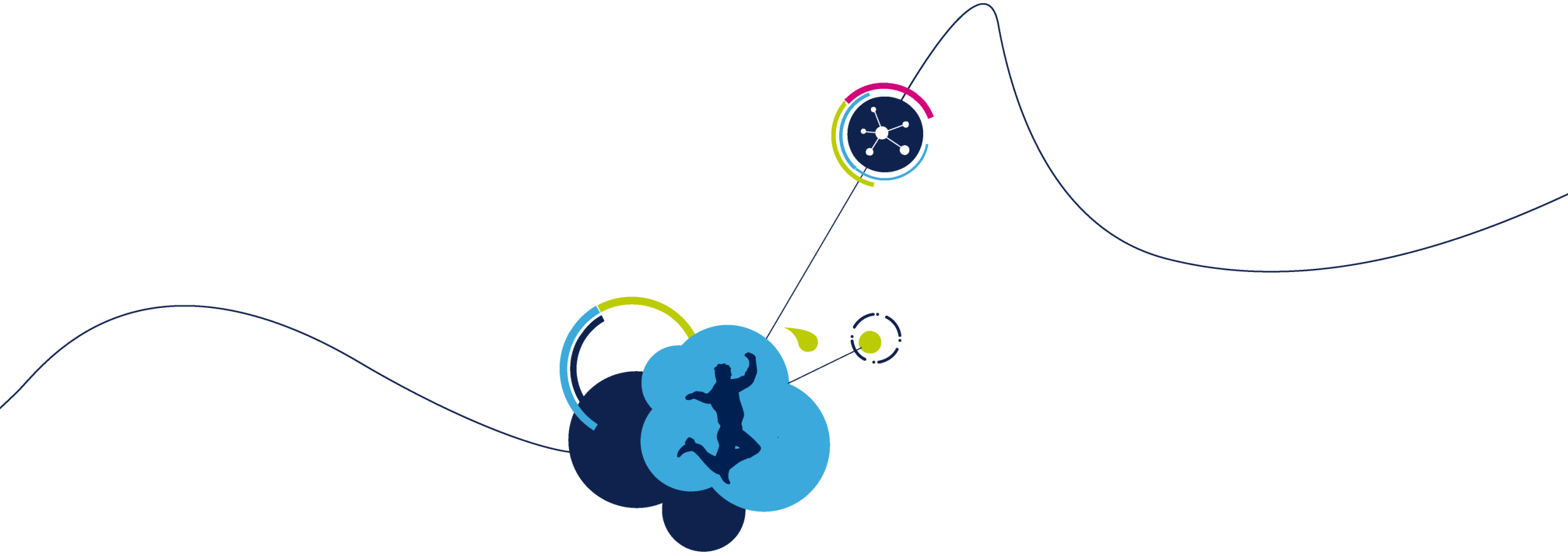

Hardware Development Tools



life.augmented

Wide offer of hardware tools

ST offers a comprehensive choice of hardware tools from starter kits to evaluation kits to emulation systems

Modular approach for maximum scalability

The hardware modular approach guarantee high flexibility in development and application scalability

The SPC5 kits are the reference system for the automotive family of microcontrollers.

From first evaluation to application specific development, SPC5 kits allow full access to CPU's signals and motherboard's peripherals such as CAN, SCI, LIN and Flex-Ray

**Easily prototype
your application
on device and
system
platforms**

Smart
Driving



Promotion and Evaluation Boards

- Two level of boards to satisfy all needs
 - Premium Evaluation boards
 - Access all peripherals, change MCU using socket and mini-modules
 - Port for JTAG and Nexus trace debuggers
 - Discovery/Discovery+ Boards
 - IC soldered on PCB with customer option to change it
 - Embedded debugger
 - Legacy Automotive connector
 - Connectivity Ports (Can / LIN)
 - Arduino-Compatible (Pictus Discovery+ only)



Promote the solution enabling immediate user operation
Connect to other system in automotive environment
Debug your application
Connect extension modules with ST smart power devices
Connect ARDUINO World



SPC5 Discovery kits

12

An entry-level solution with integrated debugger to enable a quick evaluation of main functionalities at an affordable cost *

The expansion connector makes it easy to plug in application and extension modules for rapid prototyping, while Arduino-compatible connectors allow the use of a wide choice of specialized shields

Developers benefit from the fully customizable SPC5Studio development environment with its intuitive user interface

**Evaluate SPC5
MCUs at a budget
price**

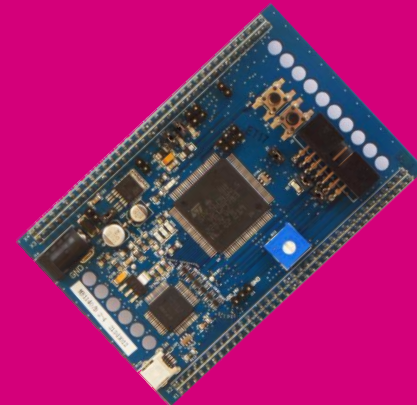

* Features depending from specific Discovery



life.augmented

Downloaded from [Arrow.com](https://www.arrow.com)

Discovery kits

Line	Part number	Description	Supported devices
SPC56 A line	SPC564A-DISP	Discovery Kit for the SPC56 A Line with SPC564A70L7.	SPC564A70L7
SPC56 B line	SPC560B-DIS	Discovery Kit for the SPC56 B Line with SPC560B54L5.	SPC560B54L5
SPC56 D line	SPC560D-DIS	Discovery Kit for the SPC56 D Line with SPC560D40L1.	SPC560D40L1
SPC56 L line	SPC56EL70L5DISP	Discovery Kit for the SPC56 L Line with SPC56EL60L5.	SPC56EL60L5
SPC56 M line	SPC563M-DISP	Discovery Kit for the SPC56 M Line with SPC563M64L7.	SPC563M64L7
SPC56 P line	SPC560P-DISP	Discovery Kit for the SPC56 P Line with SPC560P50L5.	SPC560P50L5
SPC57 K line	SPC574K-DIS	[Available soon] Discovery Kit for the SPC57 K Line with SPC574K72E5.	SPC574K72E5
SPC57 S line	SPC570S-DISP	Discovery Kit for the SPC57 S Line with SPC570S50L3.	SPC570S50L3
SPC58 B line	SPC582B-DIS	[Available soon] Discovery Kit for the SPC58 B Line with SPC582B60E1.	SPC582B60E1
	SPC584B-DIS	[Available soon] Discovery Kit for the SPC58 B Line with SPC584B70E1.	SPC584B70E1



SPC5 Premium evaluation boards

With SPC5 Premium boards developers can quickly evaluate all the functionalities of SPC5 automotive MCUs.

Adapter boards are available for each specific device line and package granting full access to all of the CPU's signals and motherboard peripherals for advanced development.

Supported by both SPC5 Studio and 3rd party software tools

**Modular approach
saves
development time
and costs**

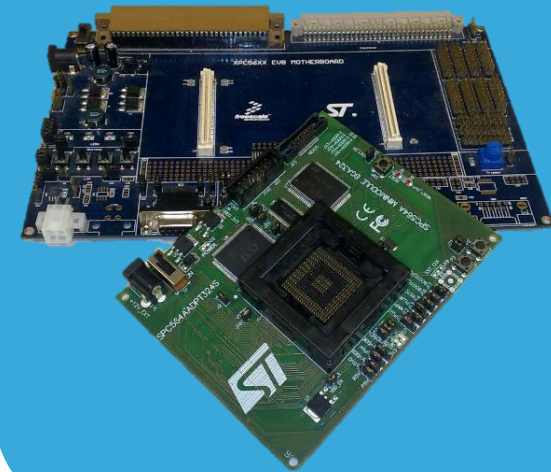

Premium evaluation board features

- Modular evaluation system for the SPC5 microcontroller's families
- Single 12V external power supply
- Four on-board regulators
- 5.0 V, 3.3 V and 1.25 V switching regulators
- 5 V linear regulator for the ADC supplies and references
- Master power switch and regulator status LEDs
- Two 240-way high-density expansion connectors for MCU daughter cards
- All MCU signals readily accessible at a port-ordered group of 0.1" pitch headers
- RS232/SCI physical interface and standard DB9 female connector
- FlexRAY channels interface with a DB9 connector (for both transceivers) and alternative connectors
- LINFlexD interface with two different style connectors
- High speed CAN channels and two female standard DB9 connectors
- Ethernet interface with a standard RJ45 Ethernet connector
- Potentiometer for analog voltage input
- User switches and LED's freely configurable



Premium evaluation boards

SPC56 family, B, C and D lines

Line	Part number	Description	Supported devices
B line	SPC560B64A100S	Socketed mini module for B-Line, C-Line and D-Line in LQFP100 package.	SPC560B40L3 SPC560B50L3 SPC560B54L3 SPC560B60L3 SPC560C40L3 SPC560C50L3 SPC560D30L3 SPC560D40L3
	SPC560B64A208S	for B-Line in BGA208 package.	SPC560B50B2 SPC560B64B2
	SPC560BADPT144S	for B-Line in LQFP144 package.	SPC560B40L5 SPC560B50L5 SPC560B54L5 SPC560B60L5 SPC560B64L5
	SPC560BADPT176S	for B-Line in LQFP176 package	SPC560B64L7
	SPC560BADPT64S	for B-Line in LQFP64 package.	SPC560D30L1 SPC560D40L1
C line	SPC56EC74A176S	for Bolero 3M in LQFP176 package..	SPC56EC74L7
	SPC56EC74A208QS	for Bolero 3M in BGA208 package	SPC56EC74B1
	SPC56EC74A256S	for Bolero 3M in BGA256 package	SPC56EC74B2
	SPC560B64A100S	for B-Line, C-Line and D-Line in LQFP100 package.	SPC560B40L3 SPC560B50L3 SPC560B54L3 SPC560B60L3 SPC560C40L3 SPC560C50L3 SPC560D30L3 SPC560D40L3

*Socketed mini module Requires SPC56XXMB



Premium evaluation boards

SPC56 family, B, C and D lines

Line	Part number	Description	Supported devices
D line	SPC560B64A100S	for B-Line, C-Line and D-Line in LQFP100 package.	SPC560B40L3 SPC560B50L3 SPC560B54L3 SPC560B60L3 SPC560C40L3 SPC560C50L3 SPC560D30L3 SPC560D40L3
	SPC560BADPT64S	for B-Line in LQFP64 package. Requires SPC56XXMB.	SPC560D30L1 SPC560D40L1
All lines	SPC56XXMB	Motherboard for all SPC56x microcontrollers. Includes: universal power supply, USB cable, documentation CD.	SPC56 family



Premium evaluation boards

SPC56 family, M and A lines

Line	Part number	Description	Supported devices
M line	SPC563M64A100S	Socketed mini module for M-Line in LQFP100 package.	SPC563M64L3
	SPC563M64A176S	for M-Line and A-Line in LQFP176 package.	SPC563M60L7 SPC563M64L7 SPC564A80L7 SPC564A70L7
	SPC563MADPT144S	for M-Line in LQFP144 package.	SPC563M60L5
	SPC563MADPT176S	for M-Line and A-Line in LQFP176 package.	SPC563M60L7 SPC563M64L7 SPC564A80L7 SPC564A70L7
	SPC563MADPT208S	for M-Line in BGA208 package.	SPC563M60B2 SPC563M64B2
A line	SPC563M64A176S	for M-Line and A-Line in LQFP176 package.	SPC563M60L7 SPC563M64L7 SPC564A80L7 SPC564A70L7
	SPC564AADPT208S	for Andorra/Monaco in BGA208 package.	SPC563M60B2 SPC563M64B2 SPC564A80B2
	SPC564AADPT324S	for Andorra in BGA324 package.	SPC564A70B4 SPC564A74B4 SPC564A80B4
All lines	SPC56XXMB	Motherboard for all SPC56x microcontrollers. Includes: universal power supply, USB cable, documentation CD.	SPC56x



Premium evaluation boards

SPC56 family, P and L Lines

Line	Part number	Description	Supported devices
P line	SPC560PADPT100S	Socketed mini module for P-Line single and dal core in LQFP100 package.	SPC560P34L3 SPC560P40L3 SPC560P44L3 SPC560P50L3 SPC560P60L3 SPC56AP54L3 SPC56AP60L3
	SPC560PADPT144S	for P-Line single and dal core in LQFP144 package.	SPC560P50L5 SPC560P60L5 SPC56AP60L5
	SPC560PADPT176S	for P-Line dual core in LQFP176 package.	SPC56AP60L7
	SPC560PADPT64S	for P-Line in LQFP64 package.	SPC560P34L1 SPC560P40L1 SPC560P50L1
L line	SPC56ELADPT100S	for L-Line in LQFP100 package.	SPC56EL54L3 SPC56EL60L3 SPC56EL70L3
	SPC56ELADPT144S	for L-Line in LQFP144 package.	SPC56EL60L5
All lines	SPC56XXMB	Motherboard for all SPC56x microcontrollers. Includes: universal power supply, USB cable, documentation CD.	SPC56x



Premium evaluation boards

SPC57 family, L, K and S line

Line	Part number	Description	Supported devices
S line	SPC570SADPT100S	Socketed mini module for SPC57 V and S lines in eLQFP100 package.	SPC570S50E3 SPC574S60E3
	SPC570SADPT64S	for SPC57 V line in eLQFP64 package.	SPC570S50E1
	SPC574SADPT144S	for SPC57 S line in eLQFP144 package.	SPC574S60L5
	SPC574SADPT244S	for SPC57 S line in BGA244 package.	SPC57 S line
L line	SPC572LADPT100S	for SPC57 L line in eLQFP100 package.	SPC572L64E3
	SPC572LADPT80S	for SPC57 L line in eLQFP80 package.	SPC572L64E2
K line	SPC574KADPT144S	for SPC57 K line in eLQFP144 package.	SPC574K7XE5
	SPC58XXADPT176S	for SPC57 K line and SPC58 E/G/N lines in eLQFP176 package.	SPC574K7XE7
All lines	SPC57XXMB	Motherboard for all SPC57xx microcontrollers. Includes: universal power supply, documentation CD.	SPC57x SPC58x



Premium evaluation boards

SPC58 family, E and N lines

Line	Device	Part number	Product
E line	SPC58xExxC3	SPC58XXADPT292S	for SPC58 E/G/N lines in BGA292 package.
	SPC58xExxE7	SPC58XXADPT176S	for SPC57 K line and SPC58 E/G/N lines in eLQFP176 package.
	SPC58xExxE5	SPC58XXADPT144S	for SPC58 B/C/E/G lines in eTQFP144 package.
N line	SPC58xNxxC3	SPC58XXADPT292S	for SPC58 E/G/N lines in BGA292 package.
	SPC58xExxE7	SPC58XXADPT176S	for SPC57 K line and SPC58 E/G/N lines in eLQFP176 package.
All lines	SPC57x SPC58x	SPC57XXMB	Motherboard for all SPC57 and SPC58 microcontrollers.



Premium evaluation boards

SPC58 family, B, C and G lines

Line	Device	Part number	Description
B line	SPC584BxxE7	SPC58XXCDPT176S	for SPC57 B/C line in eLQFP176 package.
	SPC584BxxE5	SPC58XXADPT144S	for SPC58 B/C/E/G lines in eTQFP144 package.
	SPC584BxxE3 SPC582BxxE3	SPC58XXADPT100S	for SPC58 B/C lines in eTQFP100 package.
	SPC584BxxE1 SPC582BxxE1	SPC58XXADPT64S	for SPC58 B line in eTQFP64 package.
	SPC582BxxQ2	SPC58XBADPT32S	[Available soon] for SPC58 B line in QFN32 package.
C line	SPC58xCxxC3	SPC58XCADPT292S	for SPC58 C line in BGA292 package.
	SPC58xCxxE7	SPC58XCADPT176S	for SPC58 B/C line in eLQFP176 package.
	SPC58xCxxE5	SPC58XXADPT144S	for SPC58 B/C/E/G lines in eTQFP144 package.
	SPC58xCxxE3	SPC58XXADPT100S	for SPC58 B/C lines in eTQFP100 package.
G line	SPC58xGxxC3	SPC58XXADPT292S	For SPC58 E/G/N lines in BGA292 package.
	SPC58xGxxE7	SPC58XXADPT176S	for SPC57 K line and SPC58 E/G/N lines in eLQFP176 package.
	SPC58xGxxE5	SPC58XXADPT144S	For SPC58 E/G/N lines in BGA292 package.
All lines	SPC57x SPC58x	SPC57XXMB	Motherboard for all SPC57 and SPC58 microcontrollers.



SPC5 Emulation boards

STMicroelectronics and third parties solutions enable full speed tracing, monitoring and calibration of SPC5 microcontrollers

A comprehensive set of emulation boards and accessories allows emulation of all SPC5 high-level devices

Memory/Debug Top Boards, Poly-Pod and interposers complete the offer

High speed solutions for tracing, monitoring and bypassing



SPC56 Emulation Solution

- **Serial Calibration**

- JTAG: using Debug Interface
- CAN: Using CCP/XCP
- Dual Port RAM for memory emulation

- **Parallel Calibration :Vertical**

- Direct Access to ECU memory with parallel Address/Data bus
- Dual Port RAM for memory emulation

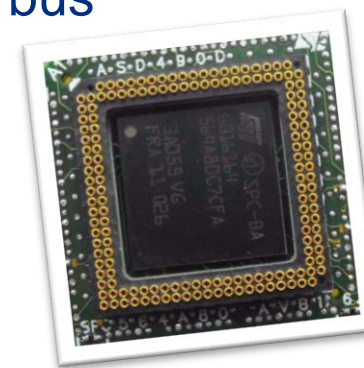
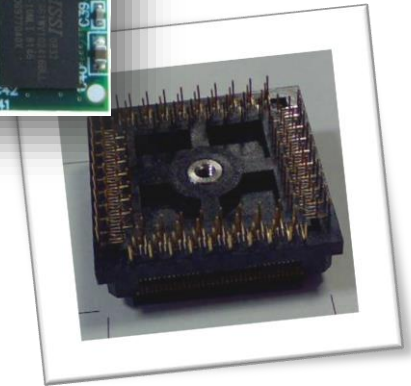
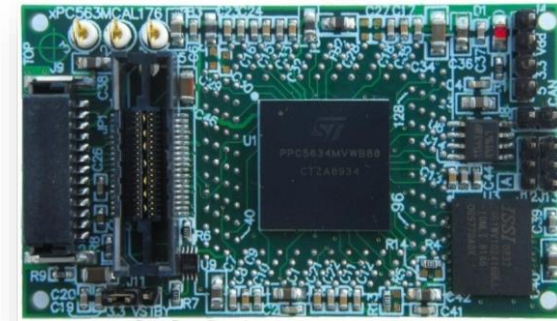

SPC56 Emulation boards

SPC56 family, A and M lines

Line	Device	Part number	Description
M line	SPC563M64L5	SPC563M64AVB144	VertiCal Base Board for M-Line target in LQFP144 package.
	SPC563M64L7	SPC563M64AVB176	VertiCal Base Board for M-Line target in LQFP176 package.
	SPC563M64L5	SPC563M64CAL144	Calibration System for Monaco 1M5 in LQFP144 target package.
	SPC563M64L7	SPC563M64CAL176	Calibration System for Monaco 1M5 in LQFP176 target package.
	SPC563M64L5 SPC563M64L7	SPC56XVTOP-M	RAM/Debug Top Board for Monaco VertiCal Base boards.
A line	SPC564A70L7	SPC564A70AVB176	VertiCal base board for A-Line 2M in LQFP176 target package.
	SPC564A70L7	SPC564A70CAL176	Calibration system for A-Line 2M in LQFP176 target package.
	SPC564A80L7	SPC564A80AVB176	VertiCal base board with Advanced Interconnect socket for Andorra 4M in LQFP176 target package.
	SPC564A80B4	SPC564A80AVB324	VertiCal base board for Andorra 4M in BGA324 target package.
	SPC564A80L7	SPC564A80CAL176	Calibration system for target Andorra 4M in QFP176 package.
	SPC564A70L7 SPC564A80L7 SPC564A80B4	SPC56XVTOP-A	RAM/Debug Top Board for Andorra VertiCal Base boards.
All lines	All devices	POLYPOD-BGA324	TQ-PolyPod for BGA324 targets.
	All devices	POLYPOD-TQ144	TQ-PolyPod for QFP144 targets.
	All devices	POLYPOD-TQ176	TQ-PolyPod for QFP176 targets.



SPC 57/58 Emulation boards

- Present a new strategy for debug and calibration operations.
- Emulation Board is for Emulation and Calibration purpose.
- The product is designed by using an Emulation Device (ED) to substitute the Production Device (PD) on an ECU version used during engine calibration.
- The buddy device integrates additional RAM, faster interfaces and improved debug features.
- The emulation/calibration board do not need external SRAM, since it is included in the Emulation Device.
- The K2 Emulation board is designed to Emulate both eTQFP176 and eTQFP144 production devices. The different footprint target will impact the choice of the adapter to buy.
- The Emulation Device in FQ216 package is mounted on board.

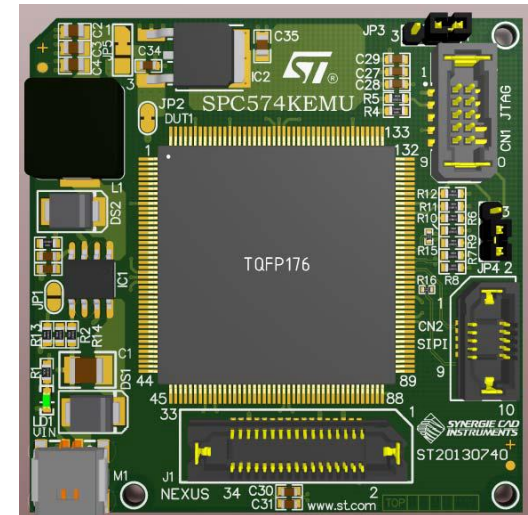
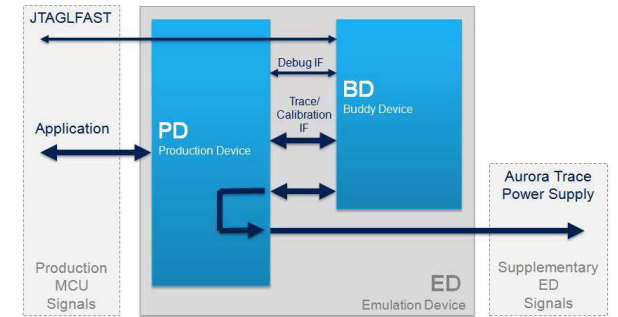

Target board adapter



SPC 57/58 Emulation boards

SPC57 family K lines, SPC58 family E/G and N lines

Line	Device	Part number	Description
SPC57 K line	SPC574KxxE7 SPC574KxxE5	SPC574KEMU	Emulation module for SPC57 K Line.
	SPC574KxxE7	SPC57KINT176EMU	Interposer for SPC574KEMU emulation module targeting eQFP176 packages.
	SPC574KxxE5	SPC57KINT144EMU	Interposer for SPC574KEMU emulation module targeting eQFP144 packages.
SPC58 E line	SPC58xExxC3 SPC58xExxE7	SPC58EEMU	Emulation module for SPC58 E/G lines.
	SPC58xExxC3	SPC57MINT292EMU	Interposer for SPC57EMEMU and SPC58EEMU emulation modules targeting BGA292 packages.
	SPC58xExxE7	SPC57MINT176EMU	Interposer SPC57EMEMU and SPC58EEMU emulation modules targeting eQFP176 packages.
SPC58 G line	SPC58xGxxC3 SPC58xGxxE7	SPC58GEMU	[Available soon] Emulation module for SPC58 E/G lines.
	SPC58xGxxC3	SPC57MINT292EMU	[Available soon] Interposer for SPC57EMEMU and SPC58EEMU emulation modules targeting BGA292 packages.
	SPC58xGxxE7	SPC57MINT176EMU	[Available soon] Interposer for SPC57EMEMU and SPC58EEMU emulation modules targeting eQFP176 packages.
SPC58 N line	SPC58xNxxC3 SPC58xNxxE7	SPC58NEMU	[Available soon] Emulation module for SPC58 N Line.
	SPC58xNxxC3	SPC57MINT292EMU	[Available soon] Target board adapter for SPC57EMEMU and SPC58EEMU emulation modules and BGA292 packages.
	SPC58xNxxE7	SPC57MINT176EMU	[Available soon] Target board adapter for SPC57EMEMU and SPC58EEMU emulation modules and BGA292 packages



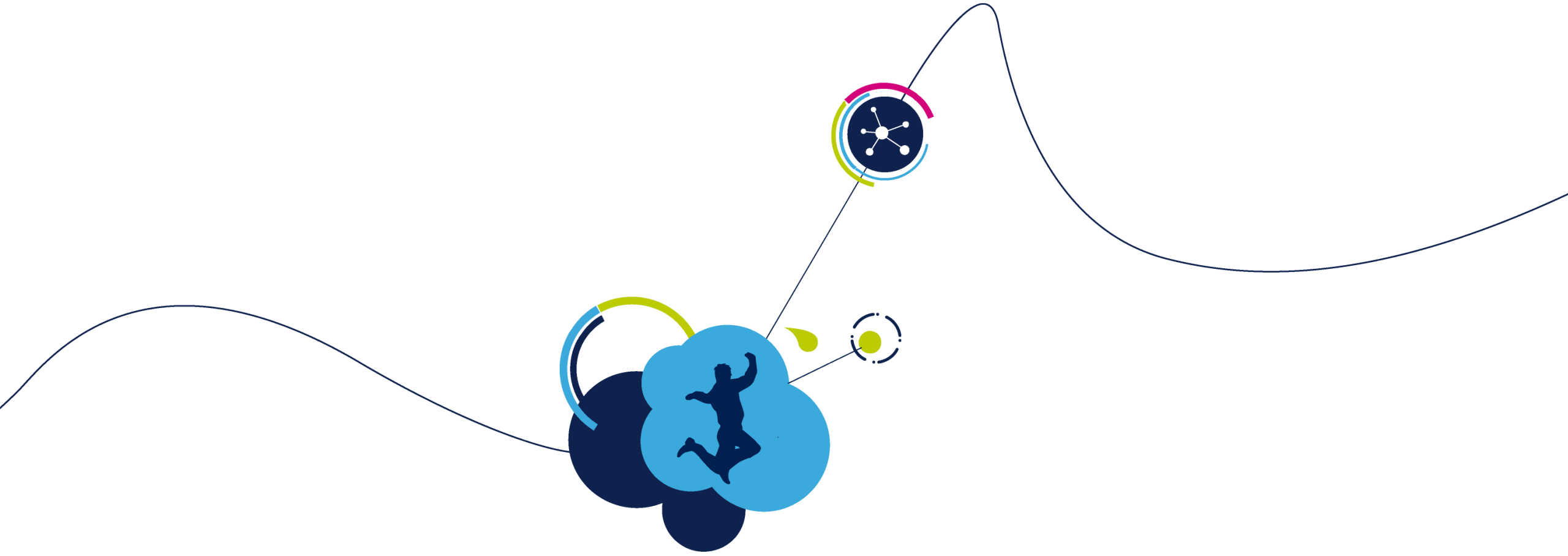

ST Flasher Tools



life.augmented

Downloaded from Arrow.com

SPC5FlashProgrammer

29

- Developed to manage the flash via SCI, CAN and K-line.
- The tool functionalities are:
 - Flash program
 - Flash Erase
 - Flash dump
 - Flash Verify
 - Flash blank check
- The top level diagram of the SPC5 Flash Programmer.

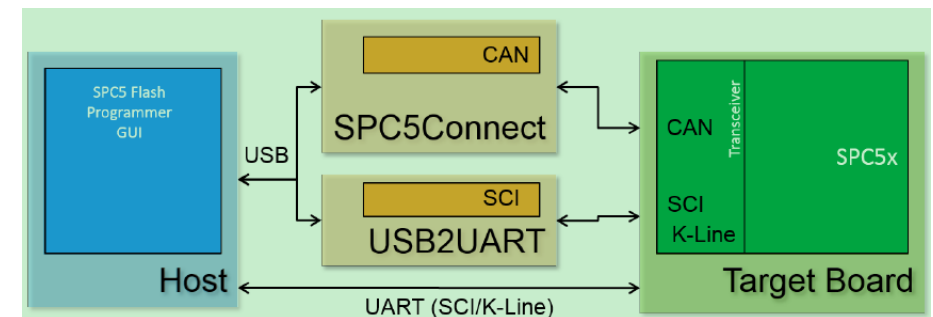
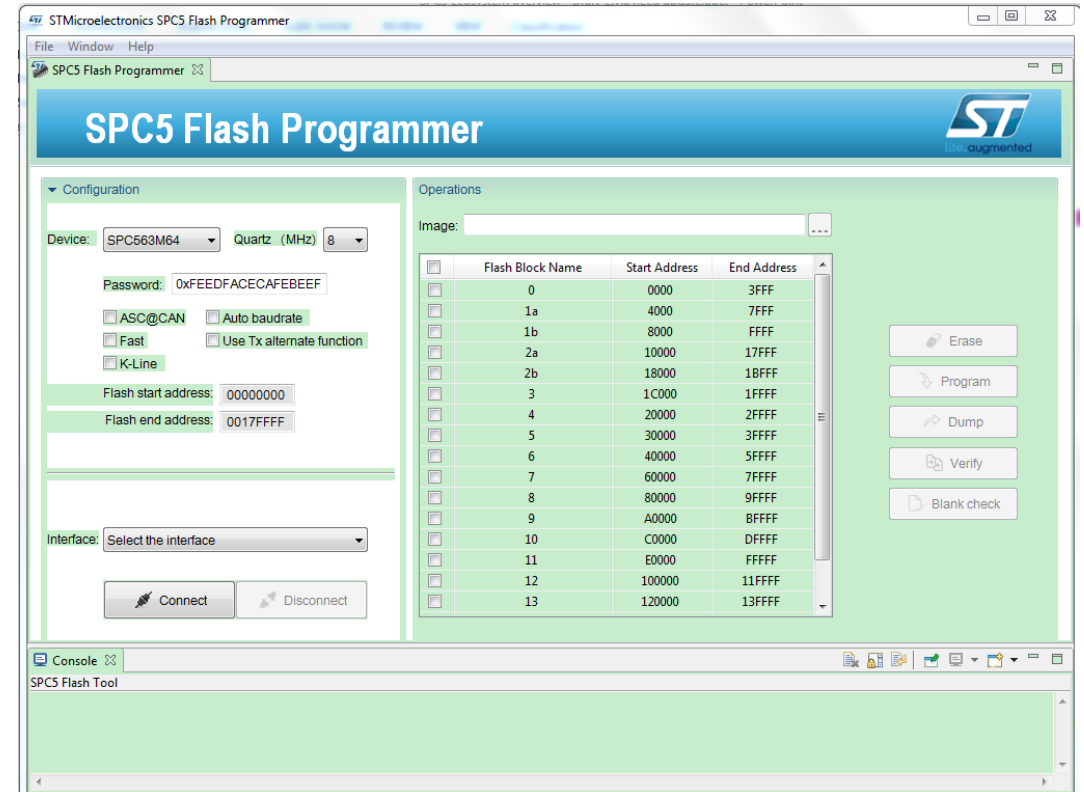

life.augmented

SPC5FlashProgrammer

Supported devices

All configuration available are described in the following table:

Family	Target	CAN*	SCI*	K-Line*
Leopard	SPC56ELx	All	All	No
Leopard	SPC564Lx	All	All	No
Pictus	SPC560P34	8MHz, 12MHz	12MHz	No
Pictus	SPC560P40	8MHz, 12MHz, 16MHz, 40MHz	8MHz, 40MHz	No
Pictus	SPC560P44	8MHz, 12MHz, 16MHz, 40MHz	40MHz	No
Pictus	SPC560P50	8MHz, 16MHz, 40MHz	40MHz	No
Pictus	SPC56AP60	8MHz, 40MHz	8MHz	No
Bolero	SPC560D30	No	All	No
Bolero	SPC560D40	No	All	No
Bolero	SPC560B40	All	All	No
Bolero	SPC560C40	All	All	No
Bolero	SPC560B44	All	All	No
Bolero	SPC560C44	All	All	No
Bolero	SPC560B50	All	All	No
Bolero	SPC560C50	All	All	No
Bolero	SPC560B54	All	All	No
Bolero	SPC560B60	All	All	No
Bolero	SPC560B64	All	All	No
Bolero	SPC564B64	All	All	No
Bolero	SPC564B70	All	All	No
Bolero	SPC564B74	All	All	No
Bolero	SPC56EC64	All	All	No
Bolero	SPC56EC70	All	All	No
Bolero	SPC56EC74	All	All	No
Monaco	SPC563M64	8MHz, 12MHz, 16MHz	8MHz, 12MHz	8MHz, 12MHz
K2	SPC574K72	No	20MHz, 40MHz (ASC@CAN)	No
Eiger	SPC58NE84	No	20MHz, 40MHz (ASC@CAN)	No
Bernina	SPC58NN84	No	20MHz, 40MHz (ASC@CAN)	No
Chorus	SPC58EC80	No	20MHz, 40MHz	No
Chorus	SPC582B60	No	20MHz, 40MHz	No



- A programmable USB interface designed to connect a PC to development hardware via automotive communications channels such as CAN, SCI, LIN and K-Line.
- The included extension flat cable with the 14 pin header connector and the DB9 connector makes possible to easily connect a daughter board or wrapping board for a specific application.
- SPC5Connect can be used together with SPC5Flashprogrammer to realize the Serial boot from CAN interface.



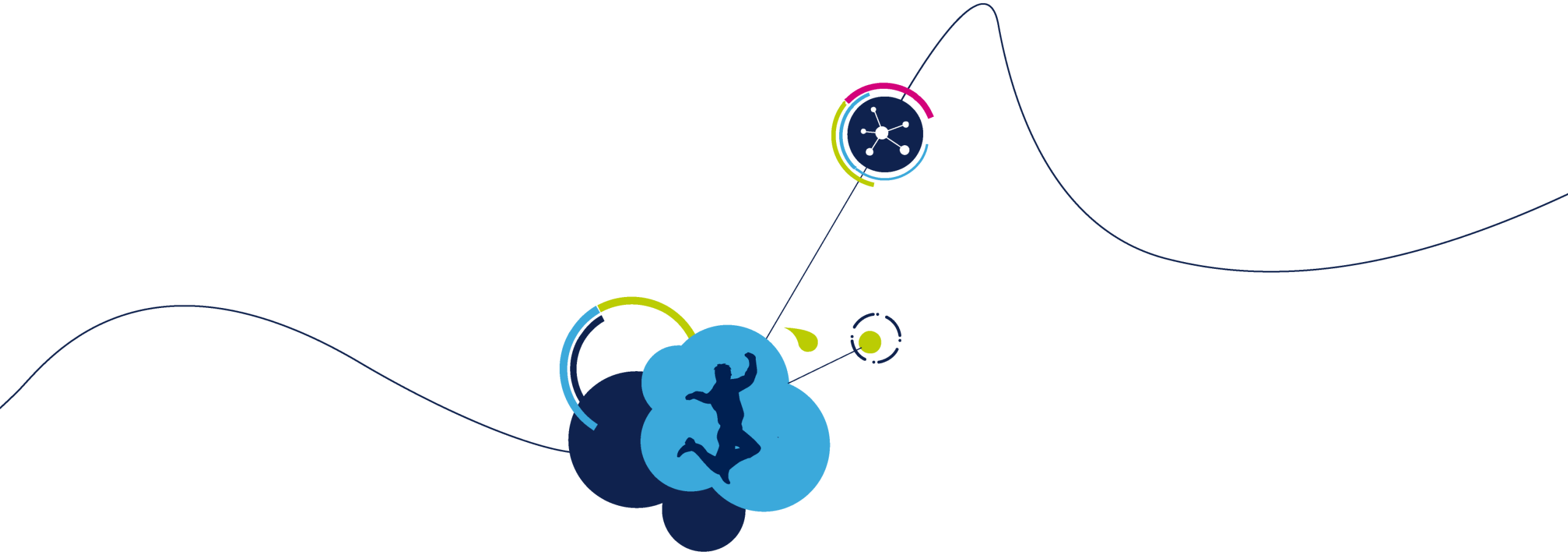

3rd Party Development Tools Support



life.augmented

Downloaded from [Arrow.com](https://www.arrow.com)

SPC58 Development Tools support

Device	HW	Status	Device	HW	Status
Eiger	Samples		Chorus	Samples	
SPC58xE	Lauterbach	Available	SPC58xG	Lauterbach	Available
SPC58xE	PLS	Available	SPC58xG	PLS	Available
SPC58xE	iSystem	Available	SPC58xG	iSystem	Available
SPC58xE	Wind River	Available	SPC58xG	Wind River	Available
SPC58xE	Green Hills	Available	SPC58xG	Green Hills	Available
SPC58xE	HighTec	Available	SPC58xG	HighTec	Available
Bernina	Samples		Chorus	Samples	
SPC58xN	Lauterbach	Available	SPC58xB/C	Lauterbach	Available
SPC58xN	PLS	Available	SPC58xB/C	PLS	Available
SPC58xN	iSystem	Available	SPC58xB/C	iSystem	Available
SPC58xN	Wind River	Available	SPC58xB/C	Wind River	Available
SPC58xN	Green Hills	Available	SPC58xB/C	Green Hills	Available
SPC58xN	HighTec	Available			

Above compilers and debuggers support all SPC56 and SPC57 and SPC58.



Ecosystem of Third Party partners

IDE/Compilers

- Green Hills MULTI
- Wind River Compiler
- HighTec GNU "C" Compiler

Debuggers/Emulators

- Lauterbach PowerTools
- PLS UDE/UADx
- iSystem ic3000/5000
- Entry level solutions from PLS, P&E and Keolabs

Calibration tools

- ETAS
- Vector
- dSPACE

Operating systems and software

- ElektroBit
- Arccore
- ETAS
- Vector
- KPIT
- i-Soft

Security Solution

- ARGUS
- ESCRYPT



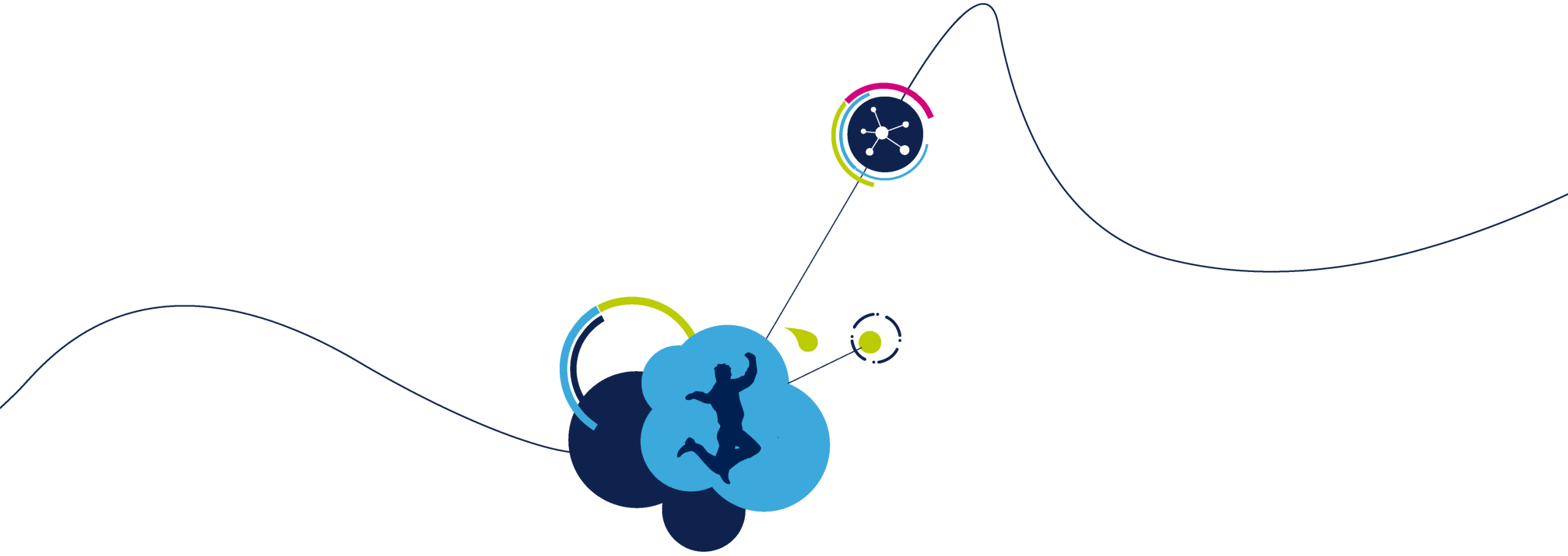

Thanks for the attention



life.augmented