



AOS
SEMICONDUCTOR

产品规格说明书

Product Data Sheet

MAX232IDR

WEB | www.aossemi.cn 



电源管理IC



通信接口芯片

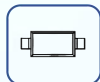

二三极管

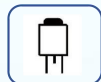

LDO稳压器

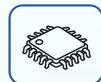

逻辑器件



MOSFETs



运算放大器



显示驱动



MCU单片机



光电器件

MAX232IDR

Data Sheet

RS-232-Chip

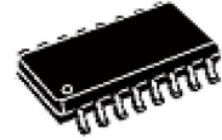

SO16

5V Dual channel RS 232 Drivers/Receivers

FEATURES

- ★ Output voltage levels are compatible with input levels of CMOS and TTL integrated circuits
- ★ Meets AI EIA/TIA-232E and V.28/N.24 Specifications
- ★ Supply voltage range from 5.5V
- ★ Low input current: 1.0μA at 25°C
- ★ Output current 30mA
- ★ Available in SOP-16 Package

APPLICATIONS

- ★ Portable Computers
- ★ Battery-Powered RS-232 Systems
- ★ Interface Translation
- ★ Low-Power Modems
- ★ Terminals

APPLICATIONS

Device	Package
	SOP-16

* Refer to the ordering information for the details.

DESCRIPTION

The MAX232IDR is a dual driver/receiver of RS-232 standard with a single supply voltage and bipolar output voltage of the transmitter formed by a built-in

multiplying generator on four 1.0μF external capacitors, designed for use in state-of-the-art high performance computing systems, high-speed electronic devices with high reliability of information exchange between remote objects. Input voltage levels are compatible with standard CMOS and TTL levels.

ABSOLUTE MAXIMUM RATINGS

PARAMETER	Symbol	MIN.	MAX.	UNIT
Supply Voltage	V_{CC}	0.3	6.0	V
Transmitter High Output Voltage	V_+	$V_{CC}-0.3$	9.8	V
Transmitter Low Output Voltage	V_-	-9.0	0.3	V
Transmitter Input Voltage	V_{TIN}	-0.3	$V_++0.3$	V
Receiver Input Voltage	V_{RIN}	-20	20	V
Voltage Applied to Transmitter Output	V_{TOUT}	$V_- - 0.3$	$V_+ + 0.3$	V
Voltage Applied to Receiver Output	V_{ROUT}	-0.3	$V_{CC} + 0.3$	V
Storage Temperature Range	Tstg	-65	150	



MAX232IDR

Data Sheet

RECOMMENDED OPERATING CONDITIONS

PARAMETER	Symbol	MIN.	MAX.	UNIT
Supply Voltage	V_{CC}	4.5	5.5	V
Transmitter Input Voltage	V_{TIN}	0	V_{CC}	V
Receiver Input Voltage	V_{RIN}	-20	20	V
Output Current of Transmitter Short Circuit	I_{SC}	-	±60	mA
Ambient Temperature Range	T_A	-40	+85	

ORDERING INFORMATION

Package	Oder No.	Package Marking	Compliance	Supplied As
SOP-16	MAX232XXX	MAX232XXX	RoHS,Green	Tube

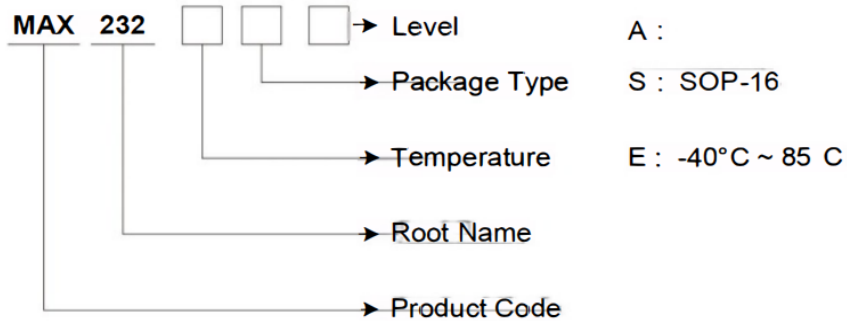

MAX232IDR

Data Sheet

PIN CONFIGURATION

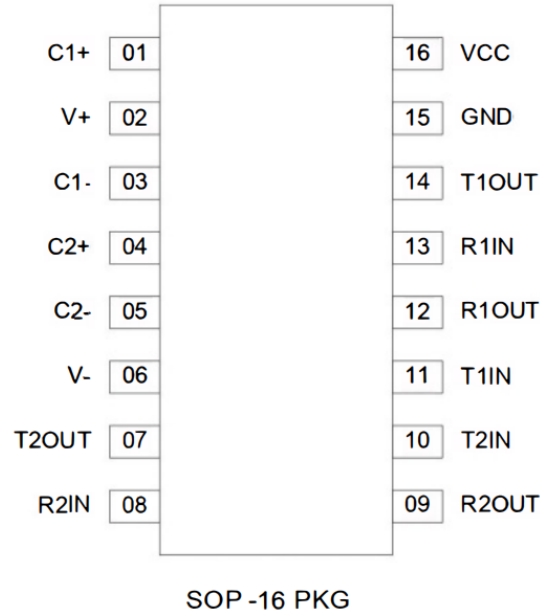

PIN DESCRIPTION

Pin No.	Pin Name	Pin Description
1	C1+	Terminal for Positive Charge-Pump C1 Capacitor
2	V+	Positive Voltage Generated by the Charge-Pump
3	C1-	Terminal for Negative Charge-Pump C1 Capacitor
4	C2+	Terminal for Positive Charge-Pump C2 Capacitor
5	C2-	Terminal for Negative Charge-Pump C2 Capacitor
6	V-	Negative Voltage Generated by the Charge-Pump
7	T2OUT	RS-232 Driver Output (Levels RS-232)
8	R2IN	RS-232 Receiver Input (Levels RS-232)
9	R2OUT	RS-232 Receiver Output (Levels TTL/CMOS)
10	T2IN	RS-232 Driver Input (Levels TTL/CMOS)
11	T1IN	RS-232 Driver Input (Levels TTL/CMOS)
12	R1OUT	RS-232 Receiver Output (Levels TTL/CMOS)
13	R1IN	RS-232 Receiver Input (Levels RS-232)
14	T1OUT	RS-232 Driver Output (Levels RS-232)
15	GND	Ground
16	VCC	Supply Voltage Input



MAX232IDR

Data Sheet

TYPICAL APPLICATION CIRCUIT

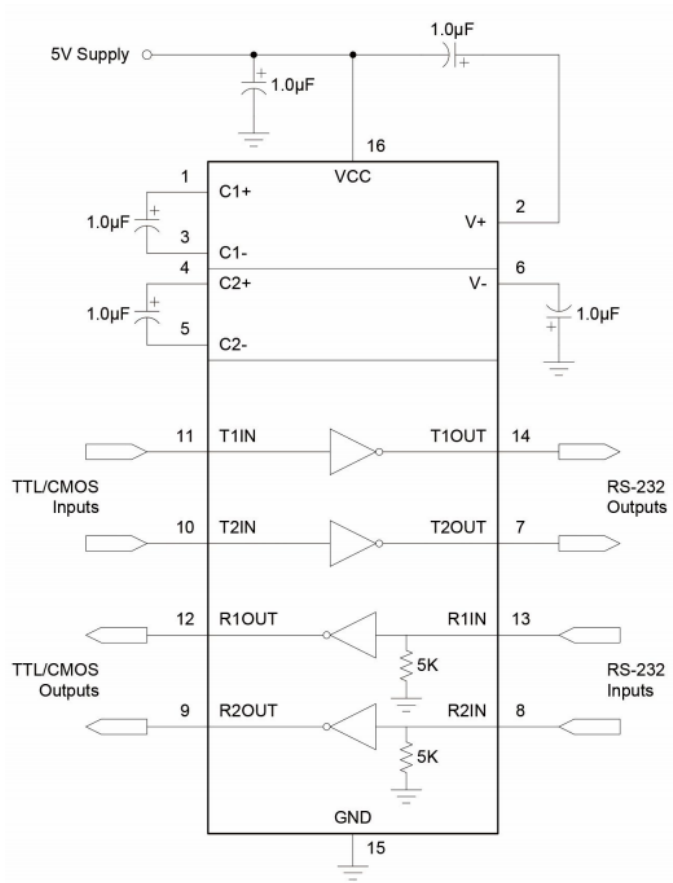

FUNCTION TABLE

INPUT(RIN, TIN)	OUTPUT(ROUT, TOUT)
L(Low Level)	H(High Level)
H(High Level)	L(Low Level)



MAX232IDR

Data Sheet

ELECTRICAL CHARACTERISTICS

(Limits in standard typeface are for TA=25°C, and the limits in boldface type apply over full operating temperature range.)

PARAMETER	SYMBOL	TEST CONDITIONS	MIN	TYP.	MAX.	UNIT.	
Supply Current	I_{CC}	$V_{CC}=5.5V$ $V_{IL}=0V$	-	-	10.0 14.0	mA	
Receiver Parameters							
Hysteresis Voltage	V_h	$V_{CC}=5.0V$	0.2 0.2	-	0.9 1.0	V	
On(Operation) Voltage	V_{on}	$V_o \leq 0.1V, I_{OL} \leq 20\mu A$	-	-	2.4 2.3	V	
Off(Dropout) Voltage	V_{off}	$V_o^- V_{CC} - 0.1V, I_{OH} = 20\mu A$	0.8 0.9	-	-	V	
Output Low Voltage	V_{OL}	$I_L = 3.2mA, V_{CC} = 4.5V, V_{IH} = 2.4V$	-	-	0.4 0.4	V	
Output High Voltage	V_{OH}	$I_{OH} = -1.0mA, V_{CC} = 4.5V, V_{IL} = 0.8V$	3.6 3.5	-	-	V	
Input Resistance	R_i	$V_{CC} = 5.0V$	3.0 3.0	-	7.0 7.0	k Ω	
Transmitter Parameters							
Output Low Voltage	V_{OL}	$V_{CC} = 4.5V, V_{IH} = 2.0V, R_L = 3.0k\Omega$	-	-	-5.2 -5.0	V	
Output High Voltage	V_{OH}	$V_{CC} = 4.5V, V_{IL} = 0.8V, R_I = 3.0k\Omega$	5.2 5.0	-	-	V	
Input Low Current	I_L	$V_{CC} = 5.5V, V_{IL} = 0V$	-	-	-1.0 -10.0	μA	
Input High Current	I_{IH}	$V_{CC} = 5.5V, V_{IH} = V_{CC}$	-	-	1.0 10.0	μA	
Speed Of Output Front Charge	S_R	$V_{CC} = 5.0V, C_L = 50-1000pF, R_L = 3.0-7.0k\Omega$	3.0 2.7	-	30 27	V/ μs	
Output Resistance	R_o	$V_{CC} = V_+ = V_- = 0V, V_o = \pm 2V$	350 300	-	-	Ω	
Short Circuit Output Current	I_{SC}	$V_{CC} = 5.5V, V_o = 0V$	$V_I = V_{CC}$	-	-	-50 -60	mA
			$V_I = 0$	-	-	50 60	
Speed Of Information Transmission	S_T	$V_{CC} = 4.5V, C_L = 1000pF, R_L = 3.0k\Omega, t_w = 7\mu s$ (for extreme, $t_w = 8\mu s$)	140 120	-	-	kbit/s	
Dynamic Parameters							
Signal Propagation Delay Time When Switching On (off)	t_{PHLR} (t_{PLHR})	$V_{CC} = 4.5V, C_L = 150pF, V_{IL} = 0V, V_{IH} = 3.0V, t_{LH} = t_{HL} \leq 10ns$	-	-	9.7 10.0	μs	
Signal Propagation Delay Time When Switching On (off)	t_{PHLT} (t_{PLHT})	$V_{CC} = 4.5V, C_L = 2500pF, V_{IL} = 0V, V_{IH} = 3.0V, R = 3k\Omega, t_{LH} = t_{HL} \leq 10ns$	-	-	5.0 6.0	μs	



MAX232IDR

Data Sheet

TIMING DIAGRAM

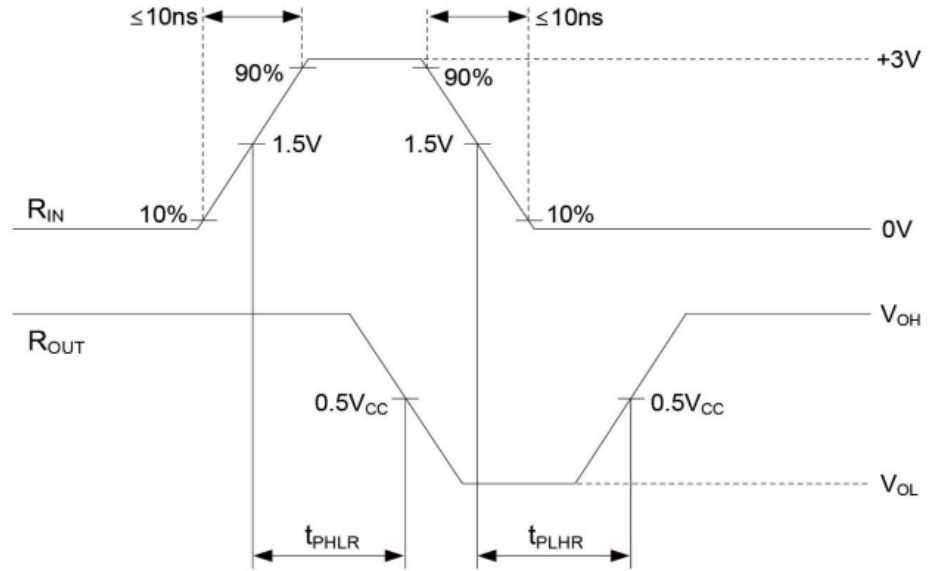
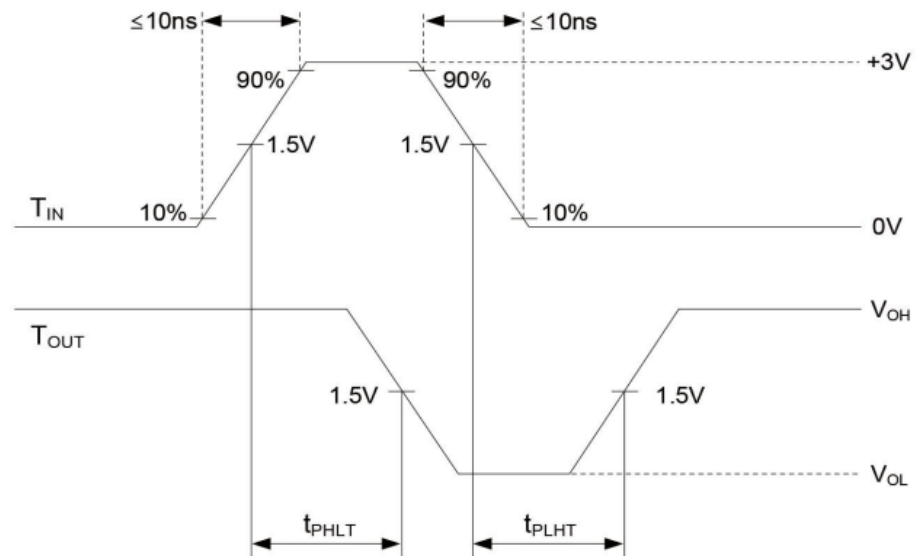
Figure 1. t_{PHL} and t_{PLH} waveforms of ReceiverFigure 2. t_{PLH} and t_{PHL} waveforms of Transmitter

MAX232IDR

Data Sheet

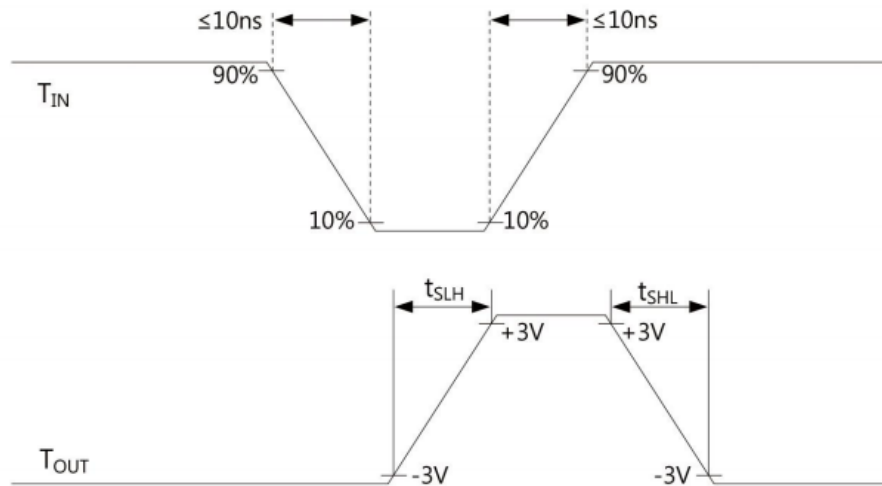
Figure 3. t_{SLH} and t_{SHL} waveforms of Transmitter

REVISION NOTICE

The description in this datasheet is subject to change without any notice to describe its electrical characteristics properly.

