

VOLTAGE RANGE

150 to 200 Volts

CURRENT

5.0 Ampere

FEATURES

- * Ideal for surface mount applications
- * Easy pick and place
- * Built-in strain relief
- * Low forward voltage drop

MECHANICAL DATA

- * Case: Molded plastic
- * Epoxy: UL 94V-0 rate flame retardant
- * Terminals: Solder plated, solderable per MIL-STD-202F method 208 guaranteed
- * Polarity: Color band denotes cathode end
- * Mounting position: Any
- * Weight: 0.063 gram

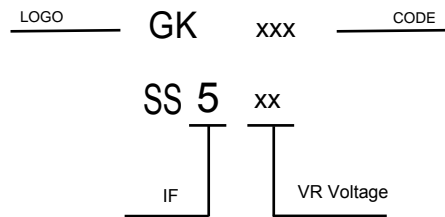
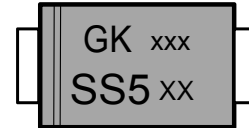

MAXIMUM RATINGS AND ELECTRICAL CHARACTERISTICS

Rating 25°C ambient temperature unless otherwise specified.
Single phase half wave, 60Hz, resistive or inductive load.
For capacitive load, derate current by 20%.

TYPE NUMBER	SS515	SS520	UNITS
Maximum Recurrent Peak Reverse Voltage	150	200	V
Maximum RMS Voltage	105	140	V
Maximum DC Blocking Voltage	150	200	V
Maximum Average Forward Rectified Current	5.0		A
Peak Forward Surge Current, 8.3 ms single half sine-wave superimposed on rated load (JEDEC method)	120		A
Maximum Instantaneous Forward Voltage at 5.0A	0.92		V
Maximum DC Reverse Current Ta=25°C	0.02		mA
at Rated DC Blocking Voltage Ta=100°C	2		mA
Typical Junction Capacitance (Note1)	250		PF
Typical Thermal Resistance RθJL (Note 2)	10		°C/W
Operating Temperature Range Tj	-65 — +175		°C
Storage Temperature Range Tstg	-65 — +175		°C

NOTES:

1. Measured at 1MHz and applied reverse voltage of 4.0V D.C.
2. Thermal Resistance Junction to Lead Vertical PC Board Mounting 0.5"(12.7mm) Lead Length.

RATING AND CHARACTERISTIC CURVES

FIG.1-TYPICAL FORWARD CURRENT DERATING CURVE

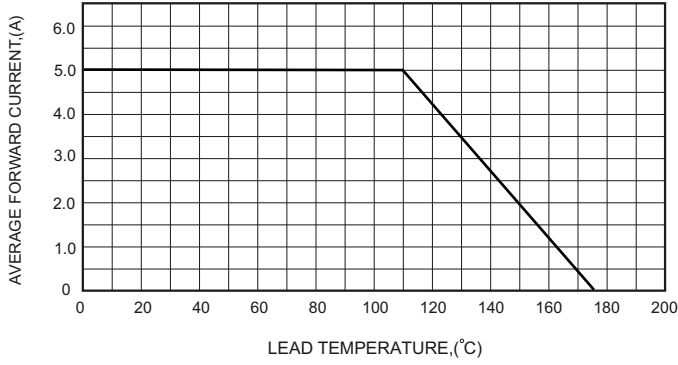

FIG.2-TYPICAL FORWARD CHARACTERISTICS

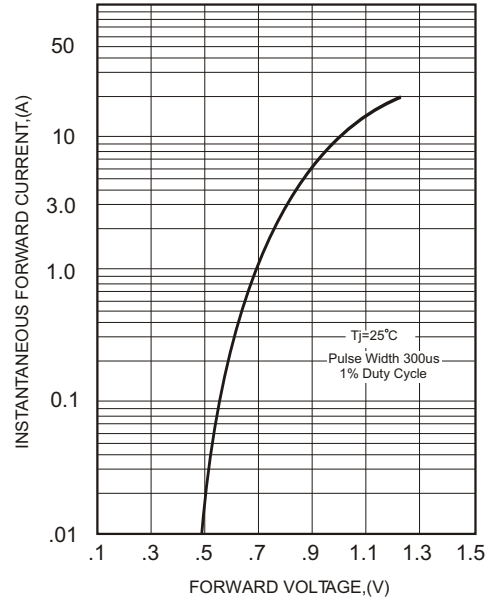

FIG.3 - TYPICAL REVERSE CHARACTERISTICS

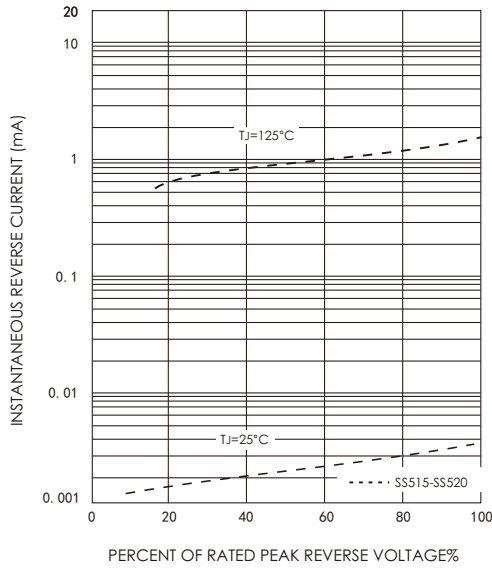

FIG.4-MAXIMUM NON-REPETITIVE FORWARD SURGE CURRENT

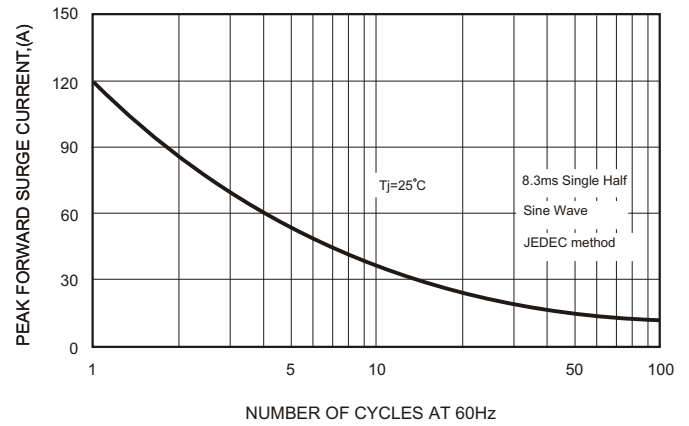
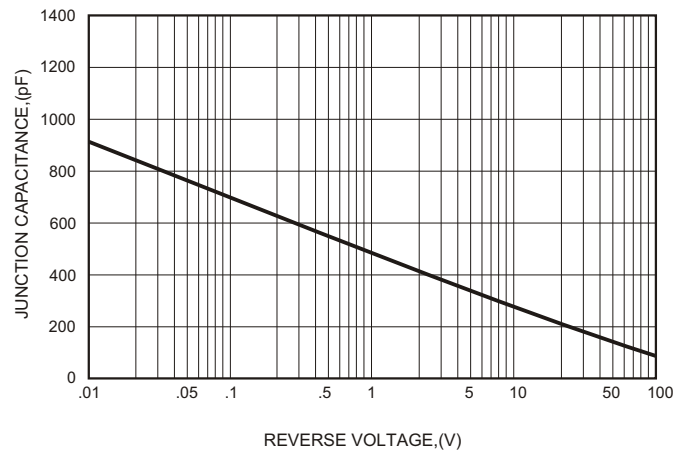
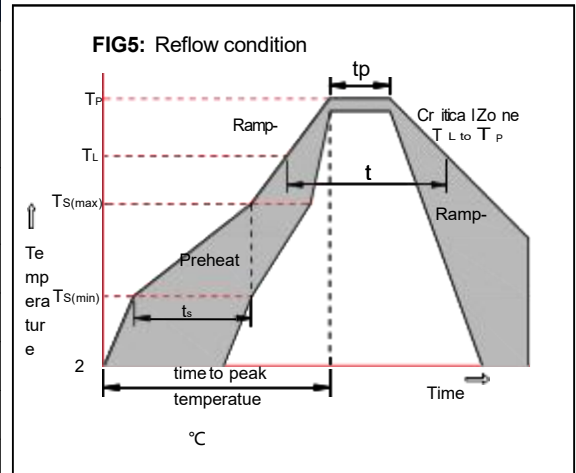

FIG.5-TYPICAL JUNCTION CAPACITANCE



Soldering parameters

Reflow Condition		Pb-Free assembly (see as below)
Pre Heat	-Temperature Min ($T_{s(min)}$)	+150°C
	-Temperature Max($T_{s(max)}$)	+200°C
	-Time (Min to Max) (ts)	60-180 secs.
Average ramp up rate (Liquid us Temp (T_L) to peak)		3°C/sec. Max
$T_{s(max)}$ to T_L - Ramp-up Rate		3°C/sec. Max
Reflow	-Temperature(T_L)(Liquid us)	+217°C
	-Temperature(t_L)	60-150 secs.
Peak Temp (T_P)		+260(+0/-5)°C
Time within 5°C of actual Peak Temp (t_p)		30 secs. Max
Ramp-down Rate		6°C/sec. Max
Time 25°C to Peak Temp (T_P)		8 min. Max
Do not exceed		+260°C



Package Dimensions & Suggested Pad Layout

SMA

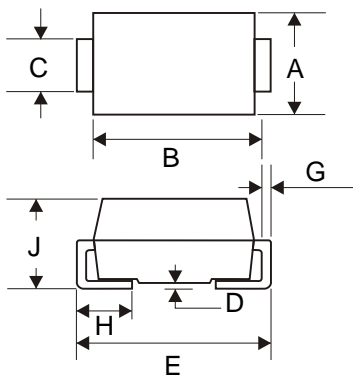

SMA		
Dim	Min	Max
A	2.40	2.79
B	3.99	4.50
C	1.32	1.47
D	-	0.20
E	4.93	5.28
G	0.15	0.31
H	0.76	1.52
J	1.98	2.29
All Dimensions in mm		

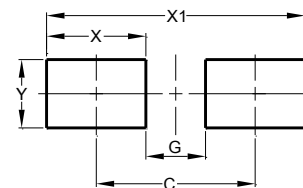

Dimensions	Value (in mm)
C	4.20
G	1.90
X	2.30
X1	6.50
Y	2.00

Tape & reel specification

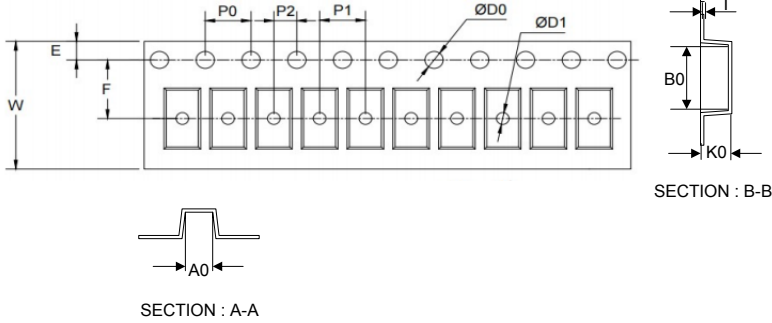
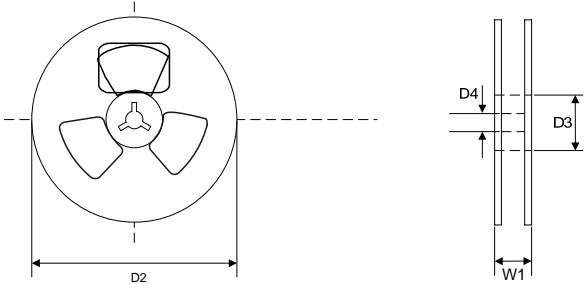
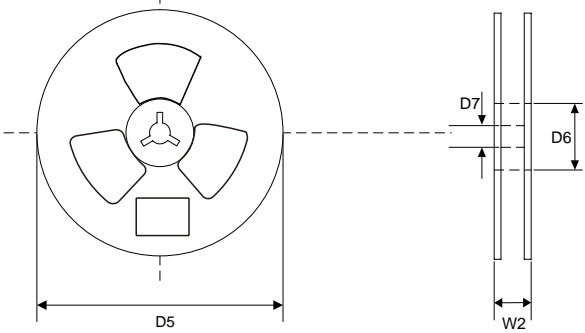
Tape	Symbol	Dimension (mm)
	P0	4.00±0.20
	P1	4.00±0.20
	P2	2.00±0.20
	D0	1.60±0.20
	D1	1.60±0.20
	E	1.75±0.20
	F	5.50±0.15
	W	12.00±0.25
	A0	2.75±0.20
	B0	5.25±0.20
K0	2.45±0.25	
T	0.20±0.10	
<p>7" Reel</p> 	D2	176.0±5.0
	D3	55.0Min.
	D4	14.0±2.5
	W1	14.0±2.5
	Quantity: 2000PCS	
<p>13" Reel</p> 	D5	330.0±5.0
	D6	73.0Min.
	D7	14.0±2.5
	W2	14.0±2.5
	Quantity: 5000PCS	