

芯位排布

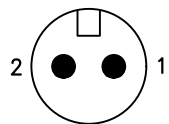

2P

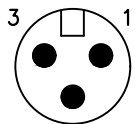

3P

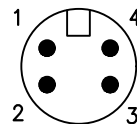

4P

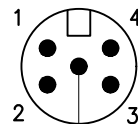

5P

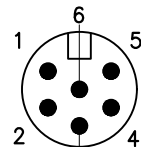

6P

芯数

2

3

4

5

6

额定电压

125V

125V

60V

60V

60V

额定电流

5V

5V

2V

2V

2V

防水等级

IP67/IP68

使用温度

-45~105°C

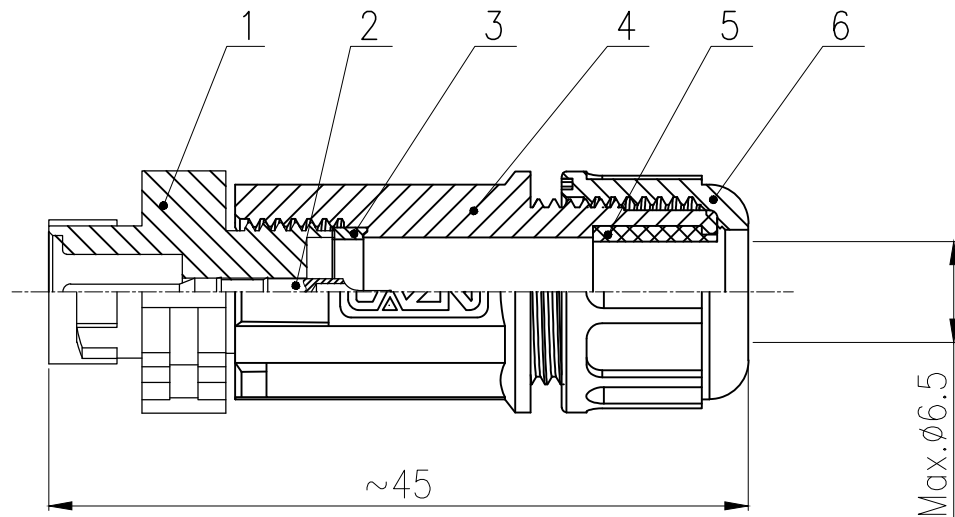
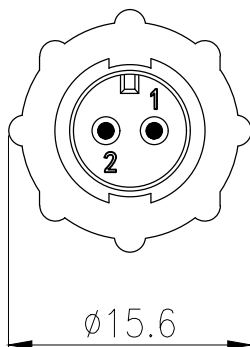

E系列 插针:

2~3P: E系列 1.0焊线式公针短针

4~6P: E系列 0.8焊线式公针短针

6	E7 紧锁螺帽	尼龙	/	pc	1
5	E10 组装式防水硅胶塞	硅胶	/	pc	1
4	E7 组装式主体	尼龙	/	pc	1
3	E7 组装式主体防水垫片 Φ8.3×Φ6.5-2	橡胶	/	pc	1
2	E系列 焊线式公针短针	黄铜	镀金	pc	2~6
1	E7 卡扣式针型对接插头外壳	尼龙	/	pc	1
No.	Specification	Material	Treat	Unit	Q'ty

GENERAL TOLERANCE (UNLESS SPECIFIED)
 ≤10 ±0.1
 <10~≤20 ±0.2
 <20~≤50 ±0.5
 Angle ±3°

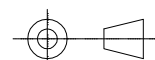

THIRD ANGLE

DWN	DATE
L.L.	2023.3.29
CHK	DATE
APVD	DATE
UNIT	REV
MM	A
SIZE	SHEET
A4	1 OF 1

	TITLE
	E7 卡扣式对接针型组装式插头
PART NO	
DRAWING NO	E7P-BK-Px