

## GRF5517

### HIGH LINEARITY POWER AMPLIFIER

#### 1.6 to 1.92 GHz

#### FEATURES

- Excellent OP1dB, OIP3, ACLR and IM3 Performance
- Native Linearity Provides up to +23 dBm  $P_{OUT}$  with > 45 dBc ACLR – Without the Need for Digital Predistortion Correction
- +23 dBm Linear Output Power Maintained at 85 °C
- Flexible Biasing Provides Latitude for Linearity Optimization
- 225 mA Native Mode Quiescent Current Consumption
- 5 V Supply Voltage
- 50  $\Omega$  Single-ended Input and Output Impedances
- Digital Shutdown
- Rugged Design is Extremely Resilient to Mismatched Loads
- -40 to 85 °C Operating Temperature Range
- Compact 3 x 3 mm QFN-16 Package

#### Reference: 5 V / 225 mA $I_{CCQ}$ / 1747 MHz

- Gain: 27.5 dB
- OIP3: 48 dBm at +23 dBm  $P_{OUT}$ /tone
- OP1dB: 32 dBm
- Noise Figure: 5.4 dB

#### APPLICATIONS

- Cellular Boosters
- Automotive Compensators
- Picocells/Femtocells
- Customer Premise Equipment

#### DESCRIPTION

The GRF5517 is a high gain, two-stage InGaP HBT power amplifier designed to deliver excellent P1dB, ACLR and IM3 performance over the 1700 to 1800 MHz band. Its exceptional native linearity makes it an ideal choice for transmitter applications that typically do not employ digital predistortion correction schemes.

This device is part of a complete family of externally matched linear amplifiers that cover the following frequency ranges:

GRF5506: 0.66 - 0.72 GHz	GRF5518: 1.8 - 2.0 GHz
GRF5507: 0.7 - 0.91 GHz	GRF5519: 1.92 - 2.2 GHz
GRF5508: 0.777 - 0.96 GHz	GRF5521: 2.11 - 2.17 GHz
GRF5510: 0.88 - 0.96 GHz	GRF5526: 2.2 - 2.7 GHz
GRF5517: 1.6 - 1.92 GHz	GRF5536: 3.3 - 4.2 GHz

Please consult with the GRF applications engineering team for custom tuning/evaluation board data.

#### BLOCK DIAGRAM

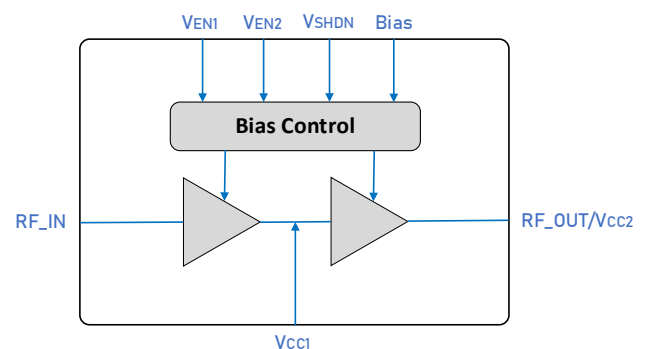

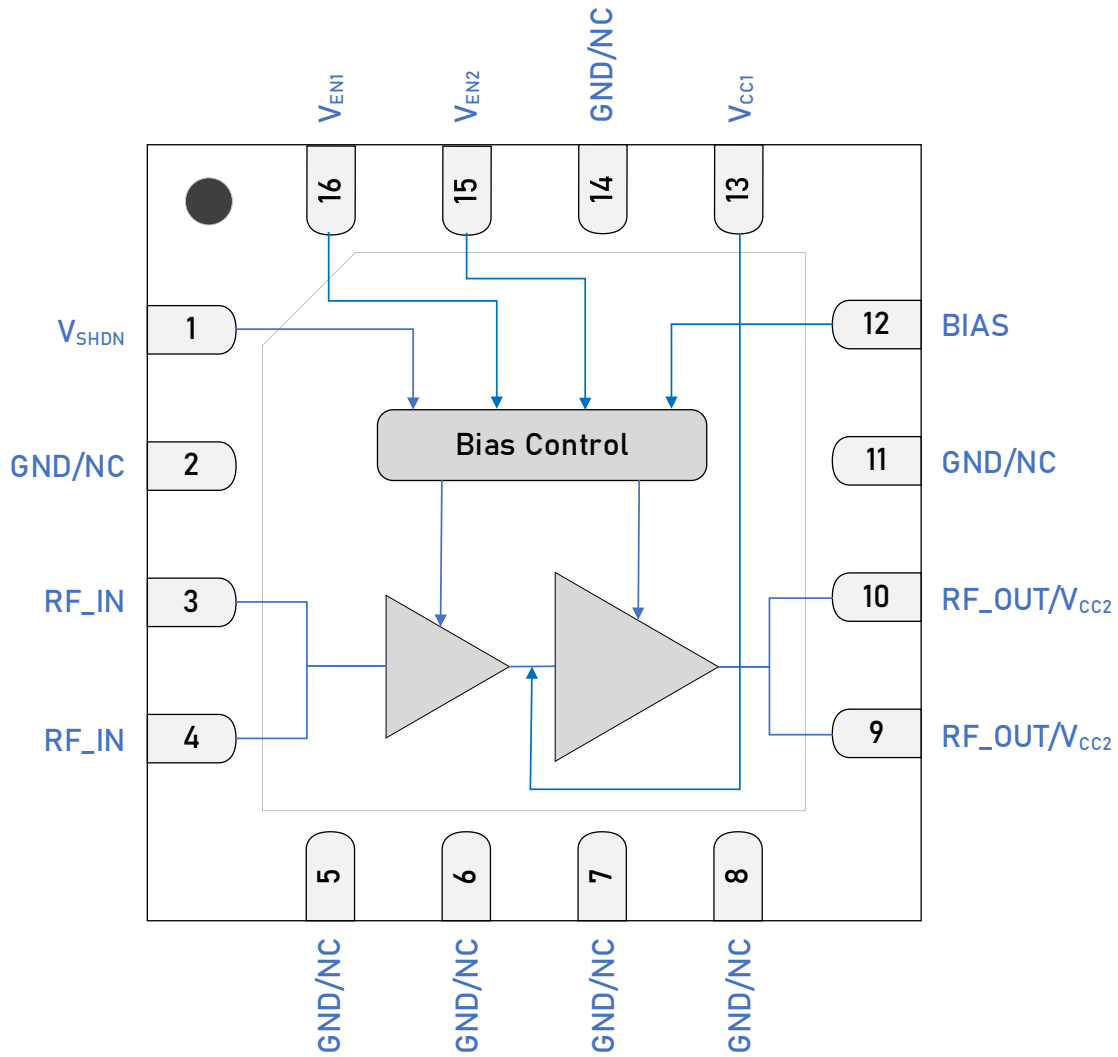

3 x 3 mm QFN-16 Pin Out (Top View)

## Pin Assignments

Pin	Name	Description	Note
1	V <sub>SHDN</sub>	Digital Shutdown Pin	V <sub>SHDN</sub> ≥ 1.7 V (Logic HIGH) disables device. V <sub>SHDN</sub> ≤ 0.9 V (Logic LOW) enables device.
2, 5, 6, 7, 8, 11, 14	GND/NC	Ground or No Connect	No internal connection to die. These pins can be left unconnected or be connected to ground (recommended). Use a via as close to the pin as possible if grounded.
3, 4	RF_IN	RF Input	Pins 3 & 4 tied together on system board. Internally matched 50 Ω. An external DC blocking capacitor must be used.
9, 10	RF_OUT/V <sub>CC2</sub>	PA Output/Bias Voltage	Pins 9 & 10 tied together on system board. V <sub>CC2</sub> must be applied to this pin via an RF choke.
12	Bias	Bias Circuit Supply	Connect to V <sub>CC2</sub> through external resistor.
13	V <sub>CC1</sub>	Bias Voltage	Connect to V <sub>CC1</sub> through external resistor.
15	V <sub>EN2</sub>	Enable2 Voltage Input	V <sub>EN2</sub> and series resistor sets I <sub>CCQ</sub> for the output stage. V <sub>EN2</sub> ≤ 0.2 volts disables stage 2.
16	V <sub>EN1</sub>	Enable1 Voltage Input	V <sub>EN1</sub> and series resistor sets I <sub>CCQ</sub> for the input stage. V <sub>EN1</sub> ≤ 0.2 volts disables stage 1. Connecting an external de-coupling capacitor to ground is required for optimal NF performance.
PKG BASE	GND	Ground	Provides DC and RF ground for the amplifier, as well as thermal heat sink. Recommend multiple 8-mil vias beneath the package for optimal RF and thermal performance. Refer to evaluation board top layer graphic on schematic page.

**Note 1:** GRF5526 and GRF5536 have a common pinout that is slightly different from the pinout shared by all the other GRF55XX PAs. Please see page 2.

## Truth Table

Pin	Logic	Condition
V <sub>SHDN</sub>	LOW	Full Operation
	HIGH	All Amplifiers Off
V <sub>EN1</sub>	LOW	Stage 1 Amplifier Off
	HIGH	Stage 1 Amplifier On
V <sub>EN2</sub>	LOW	Stage 2 Amplifier Off
	HIGH	Stage 2 Amplifier On

## Absolute Ratings

Parameter		Symbol	Min.	Max.	Unit
Supply Voltage		$V_{CC}$		5.5	V
RF Input Power	50 $\Omega$ , $V_{CC} = 5$ V, CW Tone, 100% Duty Cycle, $T_{PKG \text{ BASE}} = 25^{\circ}\text{C}$ .	$P_{IN \text{ MAX} - 1:1}$		23	dBm
	Load VSWR $\leq 8:1$ , all phase angles, $V_{CC} = 5$ V, CW Tone, 100% Duty Cycle, $T_{PKG \text{ BASE}} = -40$ to $85^{\circ}\text{C}$ .	$P_{IN \text{ MAX} - 8:1}$		20	
Operating Temperature (package base).		$T_{PKG \text{ BASE}}$	-40	85	$^{\circ}\text{C}$
Maximum Junction Temperature (MTTF > $10^6$ hours).		$T_{J \text{ MAX}}$		170	$^{\circ}\text{C}$
Maximum Dissipated Power Stage 1: DC only (no RF applied).		$P_{DISS \text{ MAX}}$		500	mW
Maximum Dissipated Power Stage 2: DC only (no RF applied).		$P_{DISS \text{ MAX}}$		1400	mW
Shutdown Voltage		$V_{SHDN}$		4	V

## Electrostatic Discharge

Charged Device Model	CDM	1000		V
Human Body Model	HBM	1000		V

## Storage

Storage Temperature	$T_{STG}$	-65	150	$^{\circ}\text{C}$
Moisture Sensitivity Level	MSL		1	--



**Caution! ESD Sensitive Device.**

**Exceeding Absolute Maximum Rating conditions may cause permanent damage.**

Note: For additional information, please refer to [Manufacturing Note MN-001 — Package and Manufacturing Information](#).



All Guerrilla RF products are provided in RoHS compliant lead (Pb)-free packaging requiring no exemptions. Additional information for this topic can be found at this link - [Environmental and Restricted Substance Statement Library](#).



### Recommended Operating Conditions

Parameter	Symbol	Specification			Unit	Condition
		Min.	Typ.	Max.		
Supply Voltage	V <sub>CC</sub>	3	5	5.5	V	
Operating Temperature (package base)	T <sub>PKG BASE</sub>	-40		85	°C	
RF Frequency Range	F <sub>RF</sub>	1.6		1.92	GHz	Typical application schematic using the 1.7 to 1.8 GHz Tuning Set ( <b>note 2</b> ).
RF_IN Port Impedance	Z <sub>RFIN</sub>		50		Ω	Single-ended with 2-element match.
RF_OUT Port Impedance	Z <sub>RFOUT</sub>		50		Ω	Single-ended with 3-element match.

**Note 2:** Contact the Guerrilla RF applications team for guidance on optimizing the tuning of the device for alternative bands.

## Nominal Operating Parameters – General

The following conditions apply unless noted otherwise: typical application schematic using the 1.7 to 1.8 GHz tuning set.  $V_{CC} = 4.75$  to  $5.25$  V,  $V_{SHDN} = \text{LOW}$ ,  $I_{CCQ} = 225$  mA,  $P_{OUT} = +23$  dBm,  $F_{TEST} = 1.7$  to  $1.8$  GHz,  $M5 = 2.26$  k $\Omega$ ,  $M9 = 2.94$  k $\Omega$ . Typical values are  $V_{CC} = 5$  V,  $I_{CCQ} = 225$  mA,  $P_{OUT} = +23$  dBm,  $F_{TEST} = 1.747$  GHz,  $T_{PKG\ BASE} = 25$  °C.  $50\ \Omega$  system impedance. Evaluation board losses are included within the specifications.

Parameter	Symbol	Specification			Unit	Condition
		Min.	Typ.	Max.		
Supply Quiescent Current	$I_{CCQ}$		225		mA	$I_{CCQ1} + I_{CCQ2}$ . No RF applied.
Supply Current with RF Applied	$I_{CC}$		305		mA	$I_{CC1} + I_{CC2}$ . $P_{OUT} = +23$ dBm.
Enable Current 1	$I_{ENABLE1}$		3		mA	$V_{CC} = 5$ V, $T_{PKG\ BASE} = 25$ °C.
Enable Current 2	$I_{ENABLE2}$		1		mA	$V_{CC} = 5$ V, $T_{PKG\ BASE} = 25$ °C.
Operating Temperature Range	$T_{PKG\ BASE}$	-40		85	°C	Measured on package base.
Logic Input LOW	$V_{IL}$	0		0.9	V	Applies to $V_{SHDN}$ input.
Logic Input HIGH	$V_{IH}$	1.7		$V_{CC}$	V	Applies to $V_{SHDN}$ input.
Logic Current LOW	$I_{IL}$		3		nA	Applies to $V_{SHDN}$ input, $V_{IL} = 0.9$ V.
Logic Current HIGH	$I_{IH}$		60		$\mu$ A	Applies to $V_{SHDN}$ input, $V_{IH} = 1.8$ V.
			280			Applies to $V_{SHDN}$ input, $V_{IH} = 3.3$ V.
Switching Rise Time	$T_{RISE}$		500		ns	Applies to $V_{SHDN}$ input.
Switching Fall Time	$T_{FALL}$		2800		ns	Applies to $V_{SHDN}$ input.

### Disabled Mode

Supply Quiescent Current	$I_{CCQ-SHDN}$		1		$\mu$ A	$V_{CC} = 5$ V, $V_{SHDN}/V_{EN1}/V_{EN2} = \text{HIGH}$ .
Enable Current 1	$I_{ENABLE1-SHDN}$		3		mA	$V_{CC} = 5$ V, $V_{SHDN}/V_{EN1}/V_{EN2} = \text{HIGH}$ .
Enable Current 2	$I_{ENABLE2-SHDN}$		1.3		mA	$V_{CC} = 5$ V, $V_{SHDN}/V_{EN1}/V_{EN2} = \text{HIGH}$ .

### Thermal Data (Stage 1 and Stage 2)

See plot of Die Temp vs. Output Power						On standard evaluation board.
---------------------------------------	--	--	--	--	--	-------------------------------

## Nominal Operating Parameters – RF: 5 V, 1.7 to 1.8 GHz Tune

The following conditions apply unless noted otherwise: typical application schematic using the 1.7 to 1.8 GHz tuning set.  $V_{CC} = 4.75$  to  $5.25$  V,  $V_{SHDN} =$  LOW,  $I_{CCQ} = 225$  mA,  $P_{OUT} = +23$  dBm,  $F_{TEST} = 1.7$  to  $1.8$  GHz,  $M5 = 2.26$  k $\Omega$ ,  $M9 = 2.94$  k $\Omega$ . Typical values are  $V_{CC} = 5$  V,  $I_{CCQ} = 225$  mA,  $P_{OUT} = +23$  dBm,  $F_{TEST} = 1.747$  GHz,  $T_{PKG\ BASE} = 25$  °C.  $50\ \Omega$  system impedance. Evaluation board losses are included within the specifications.

Parameter	Symbol	Specification			Unit	Condition
		Min.	Typ.	Max.		
Small Signal Gain	S21		27.5		dB	LTE 20MHz 100RB TM1.1 Downlink Waveform with 9.8dB PAR, $F_{TEST} = 1.747$ GHz, $V_{CC} = 5$ V, $P_{IN} = -25$ dBm.
Standby Mode Gain	S21 <sub>STBY</sub>		-22		dB	Disabled Mode, LTE 20MHz 100RB TM1.1 Downlink Waveform with 9.8dB PAR, $V_{SHDN}/V_{EN1}/V_{EN2} =$ HIGH, $P_{IN} = 0$ dBm.
Input Return Loss	S11		< -7		dB	$F_{RF} = 1.7$ to $1.8$ GHz.
Output Return Loss	S22		< -10		dB	$F_{RF} = 1.7$ to $1.8$ GHz.
Reverse Isolation	S12		> 50		dB	$F_{RF} = 1.7$ to $1.8$ GHz.
Noise Figure	NF		5.4		dB	On standard evaluation board.
Output 3rd Order Intercept Point	OIP3		48		dBm	+23 dBm $P_{OUT}$ per tone at 600 kHz spacing.
Output 1 dB Compression Power	OP1dB		32		dBm	Sine wave input, $V_{CC} = 5$ V.
Adjacent Channel Leakage Ratio	ACLR			-45	dBc	$P_{OUT} = +23$ dBm, LTE 20MHz 100RB TM1.1 Downlink Waveform with 9.8dB PAR, $F_{TEST} = 1.747$ GHz, $V_{CC} = 5$ V.
Output IMD3 Level (Using extended 1710-1920 MHz tune)	IMD3			-19	dBm	+22 dBm $P_{OUT}$ per tone at 600 kHz spacing. Typical application schematic using the 1.71 to 1.92 GHz tuning set ( <b>note 3</b> ).

**Note 3:** MIN/MAX limits defined using *modelled estimates* that account for part-to-part variations and expected process spreads. As additional production lots are fabricated, accumulated test data will be used to refine the MIN/MAX limits.



### GRF5517 Typical Operating Curves: Gain vs. P<sub>OUT</sub> (9.8 dB PAR)

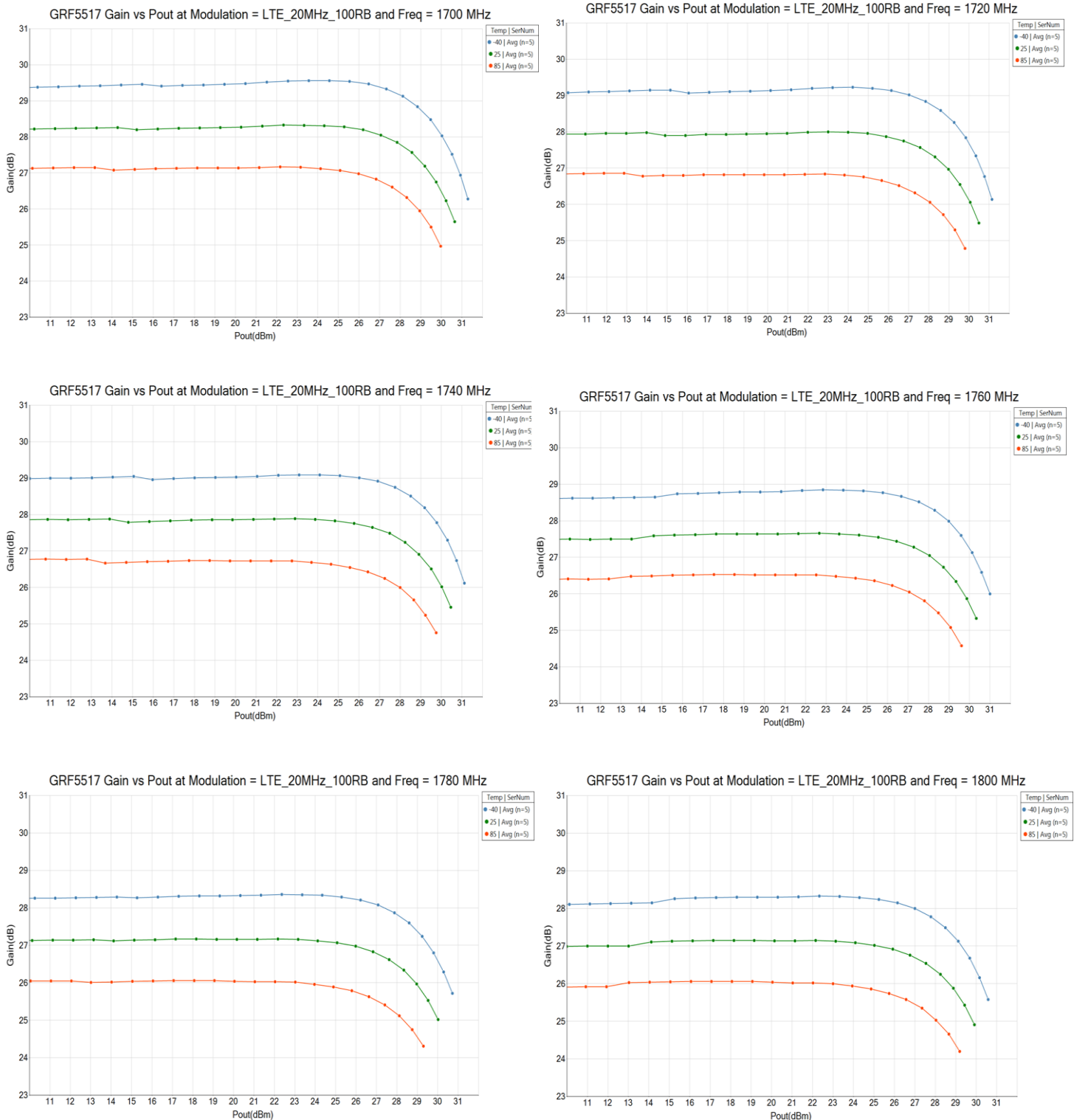



### GRF5517 Typical Operating Curves: Gain vs. P<sub>IN</sub> (Shutdown Mode, V<sub>SHDN</sub> = 3.3 V, 9.8 dB PAR)

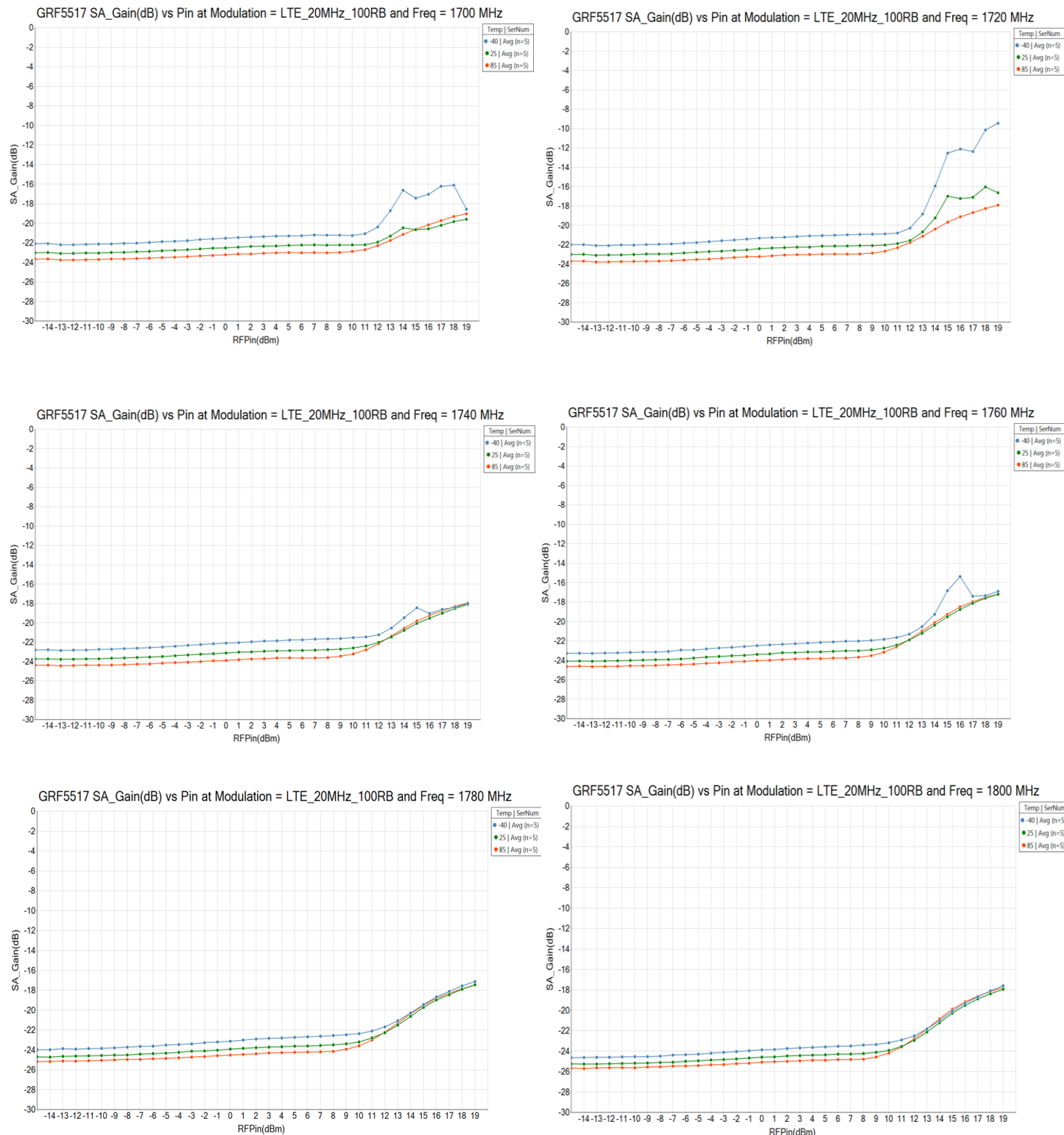



### GRF5517 Typical Operating Curves: IMD3 vs. P<sub>OUT</sub> (Per Tone with 600 kHz Tone Spacing)

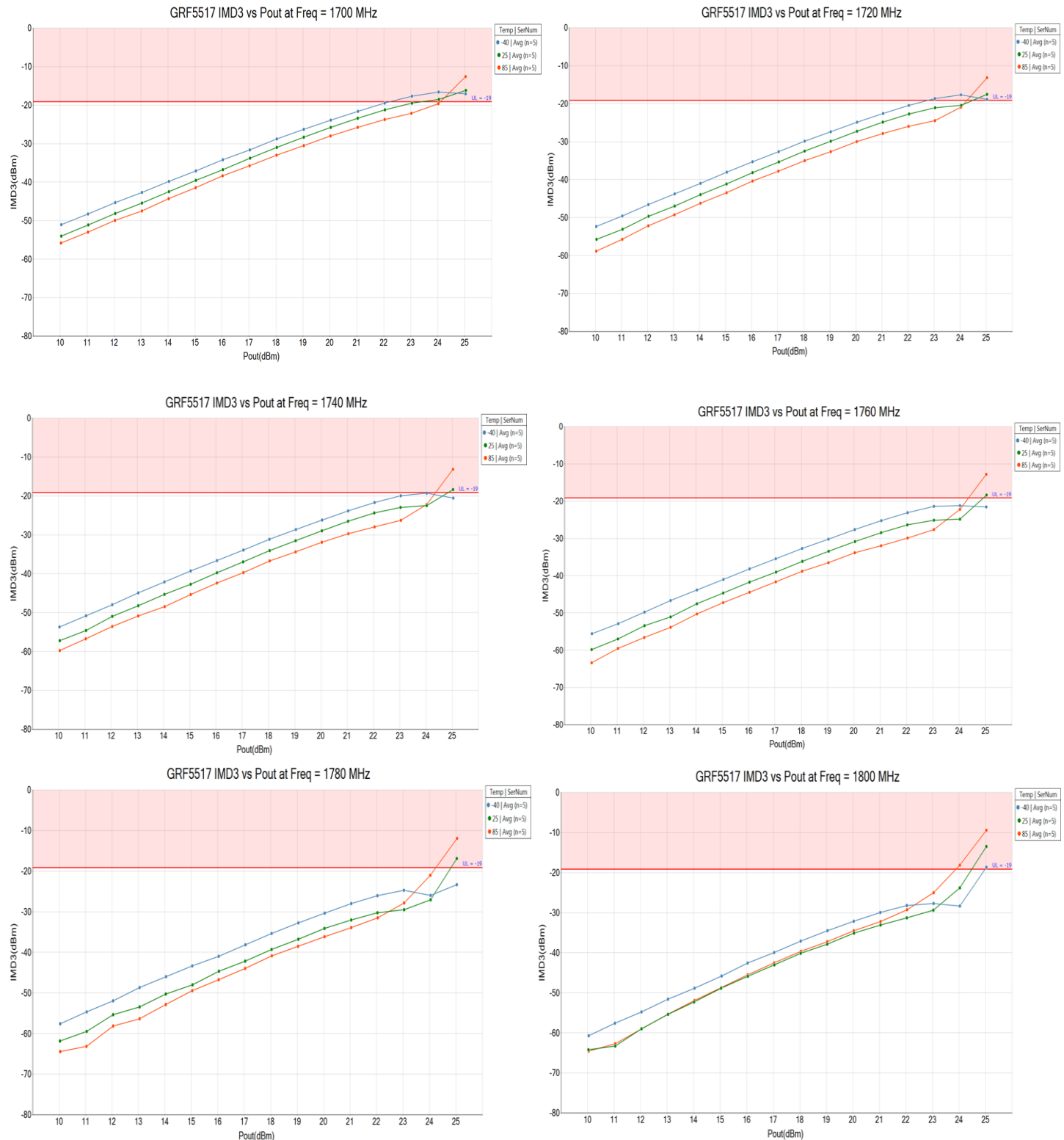



### GRF5517 Typical Operating Curves: OIP3 vs. P<sub>OUT</sub> (Per Tone with 600 kHz Tone Spacing)

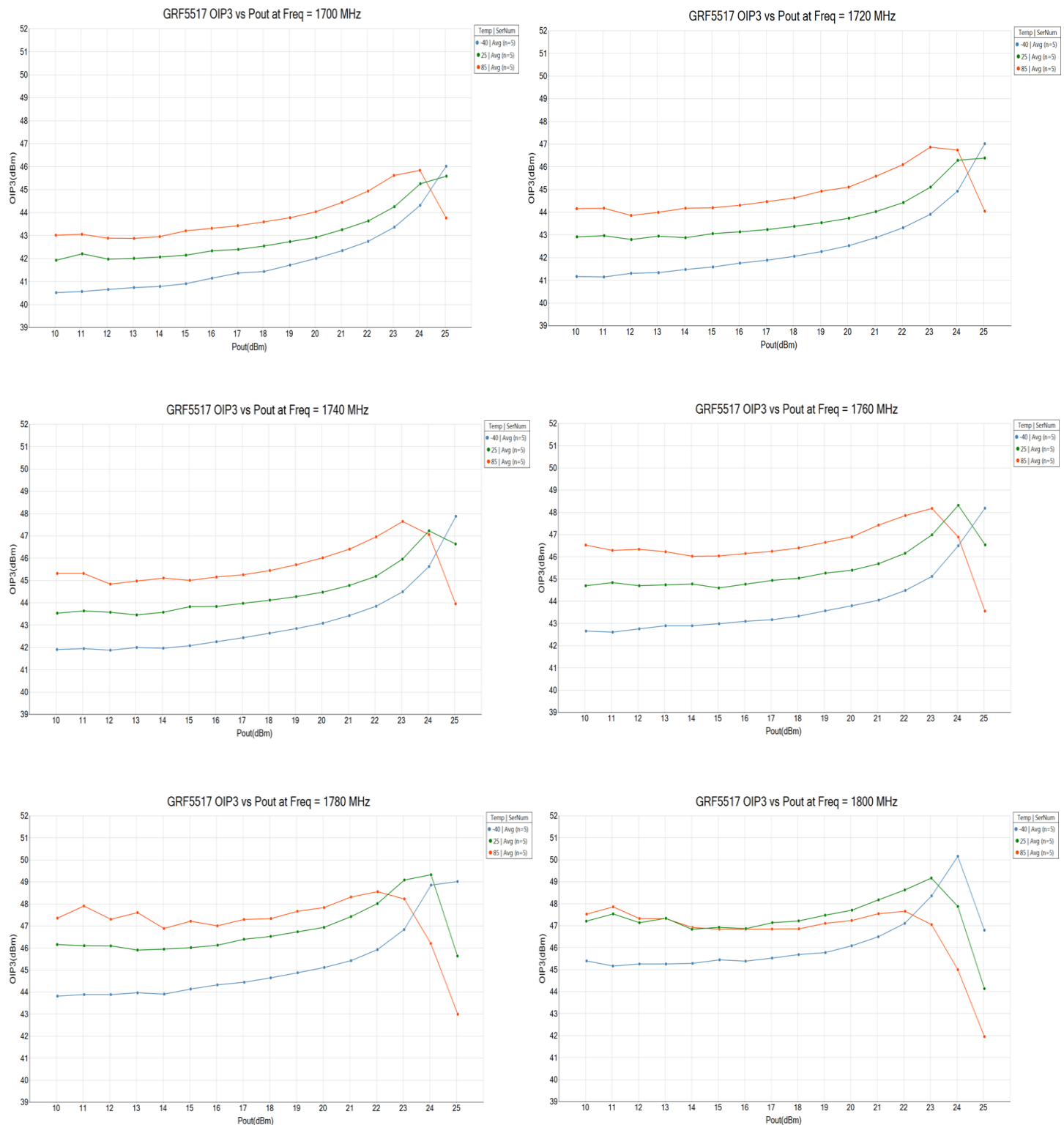

### GRF5517 Typical Operating Curves: PAE vs. P<sub>OUT</sub> (9.8 dB PAR)

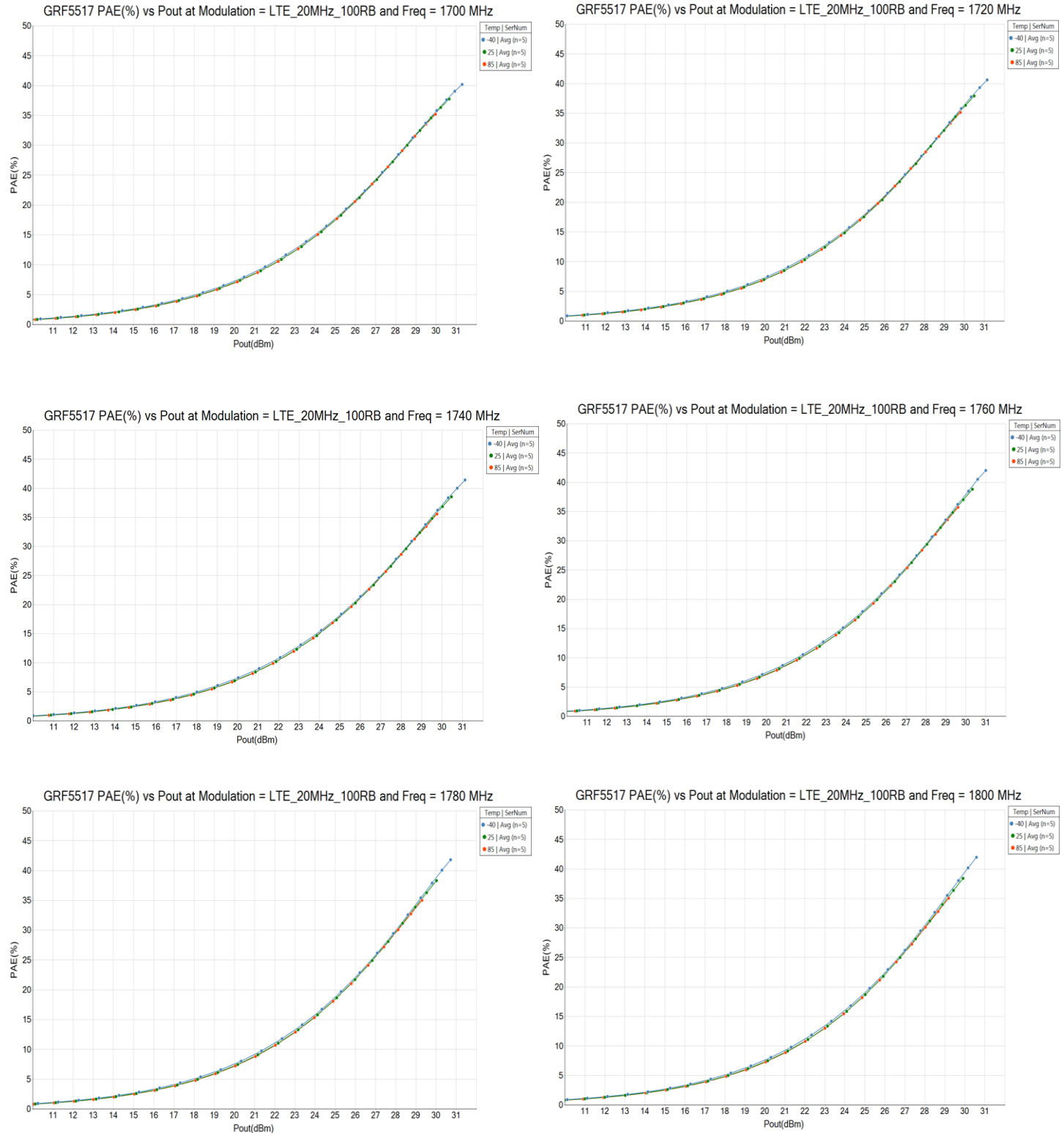

### GRF5517 Typical Operating Curves: ACLR vs. P<sub>OUT</sub> (9.8 dB PAR)

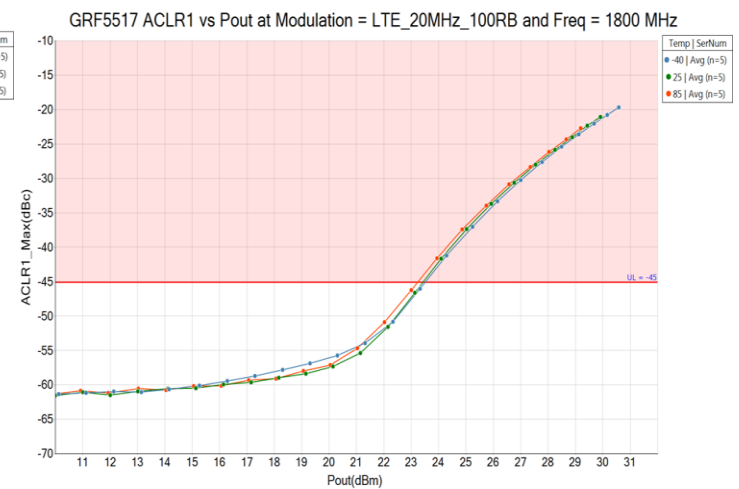
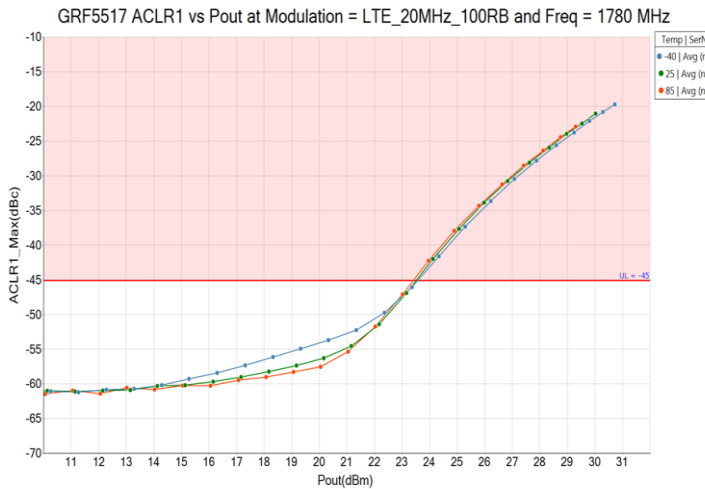
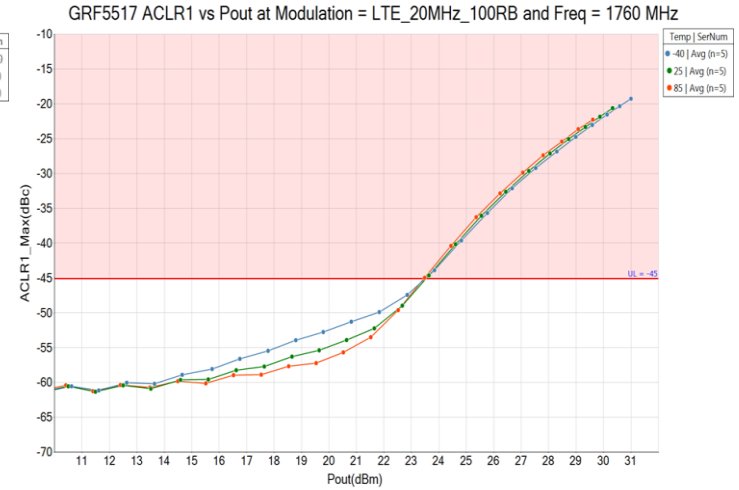
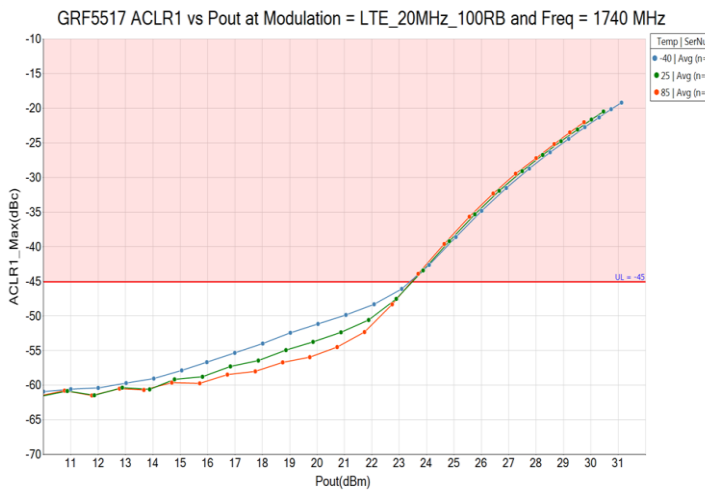
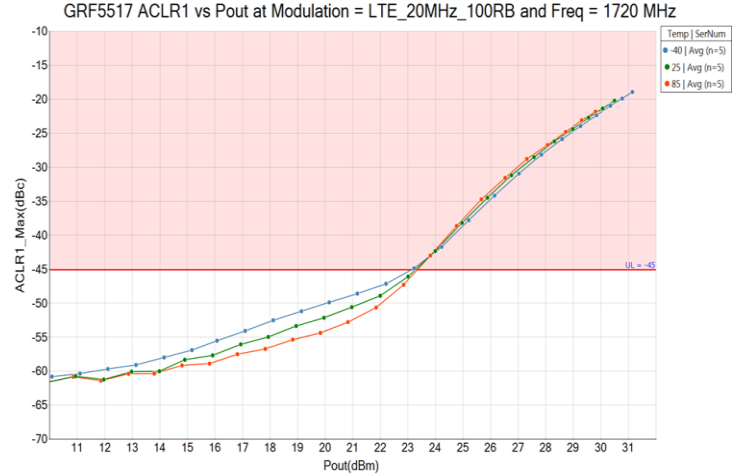
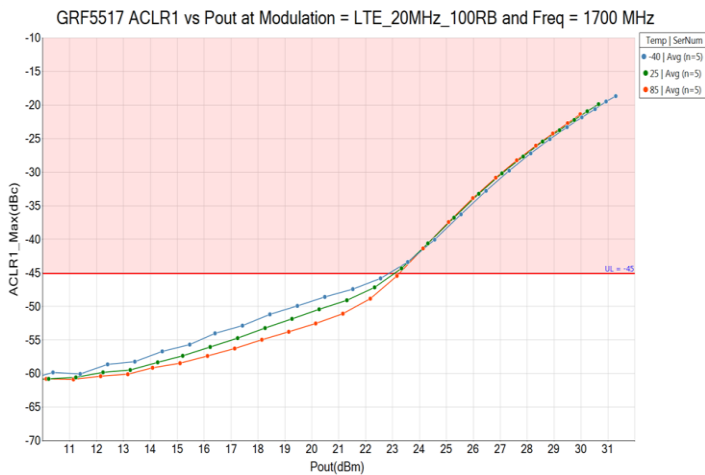



### GRF5517 Typical Operating Curves: EVM vs. P<sub>OUT</sub> (9.8 dB PAR)

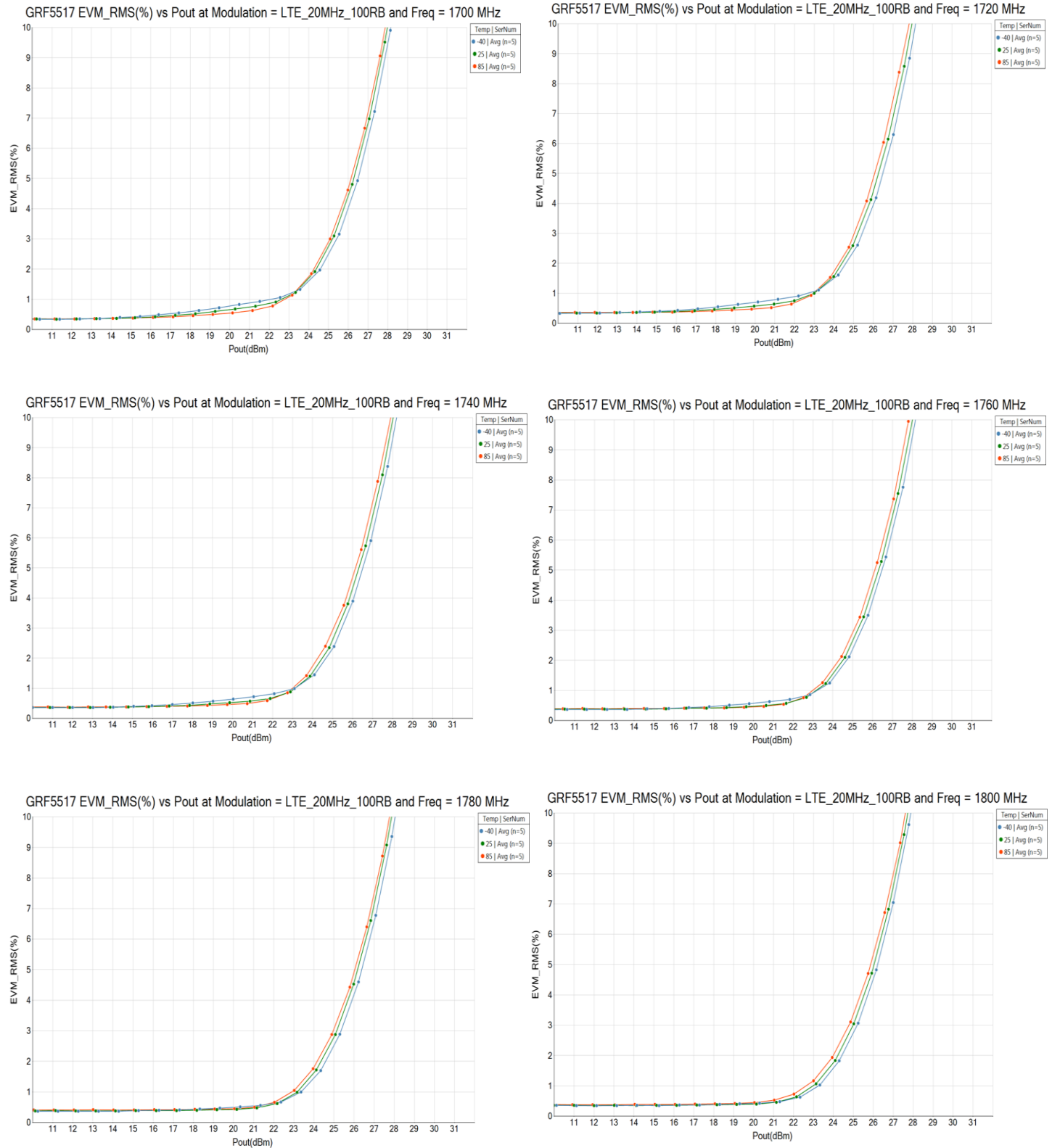



### GRF5517 Typical Operating Curves: Stage1 I<sub>CC</sub> vs. Stage2 P<sub>OUT</sub> (9.8 dB PAR)

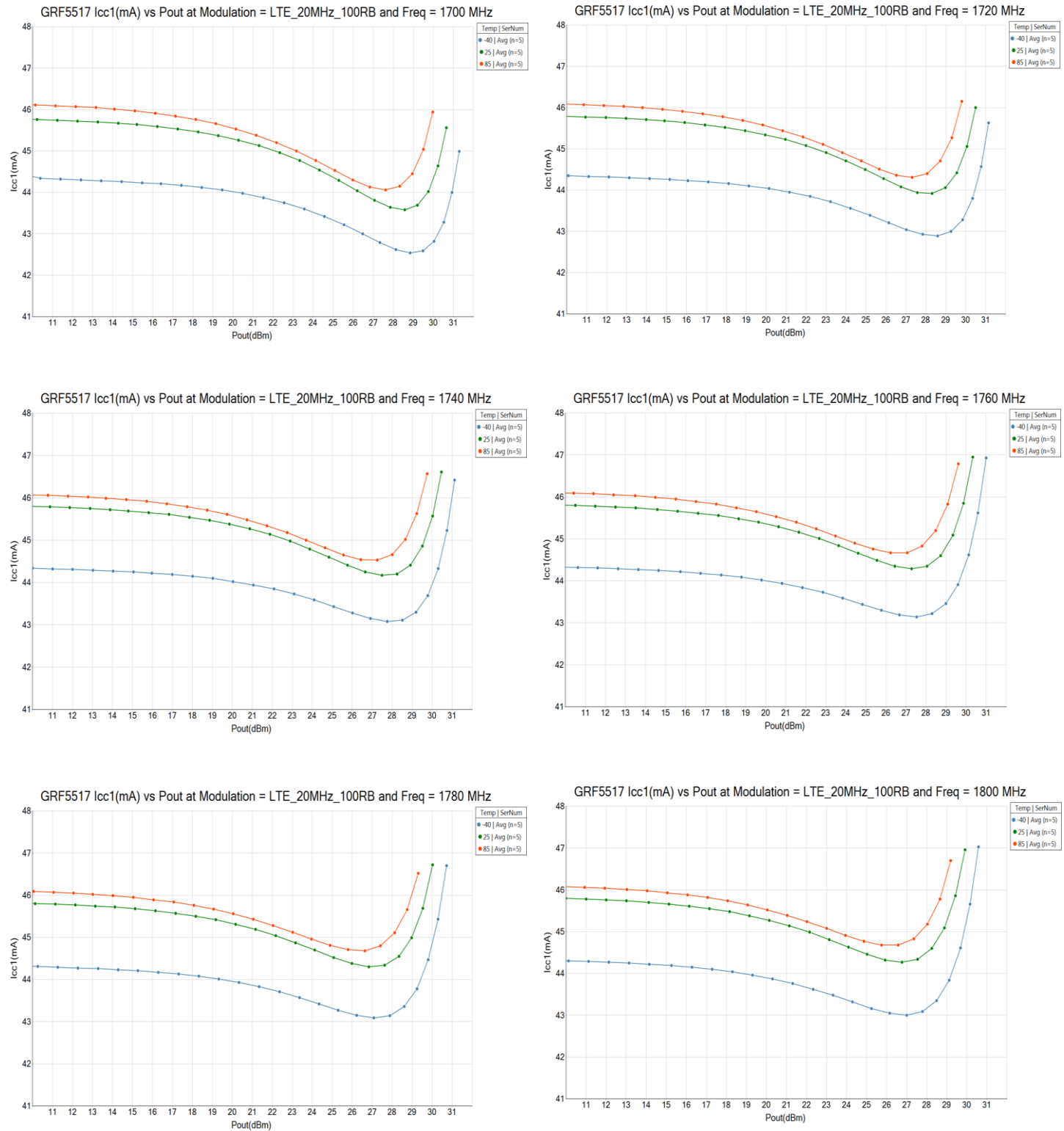



### GRF5517 Typical Operating Curves: Stage2 I<sub>CC</sub> vs. Stage2 P<sub>OUT</sub> (9.8 dB PAR)

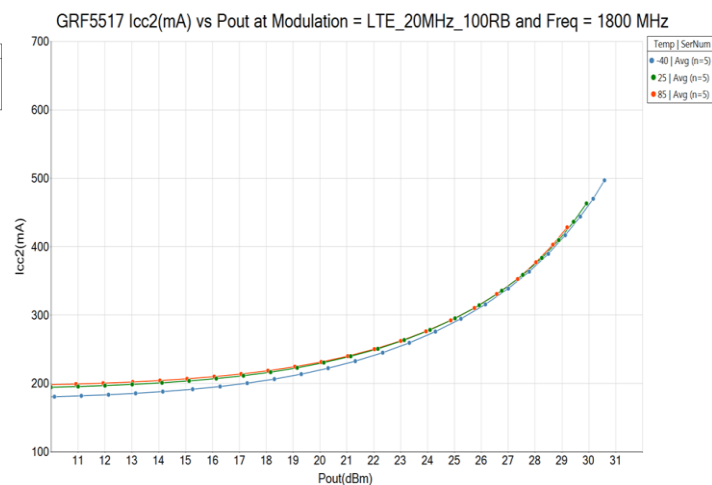
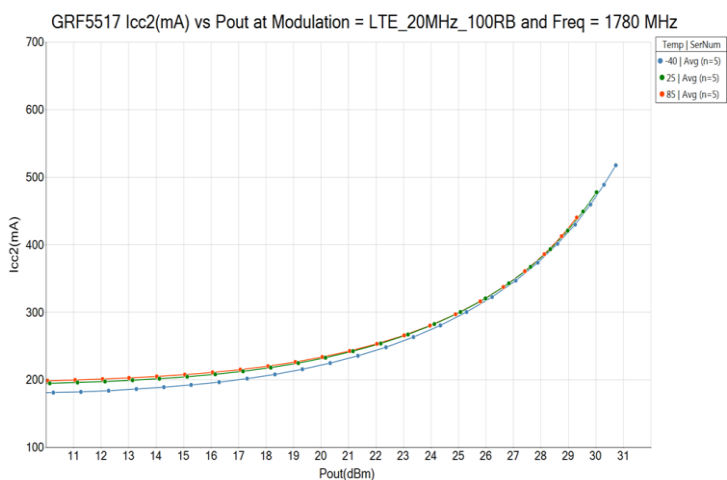
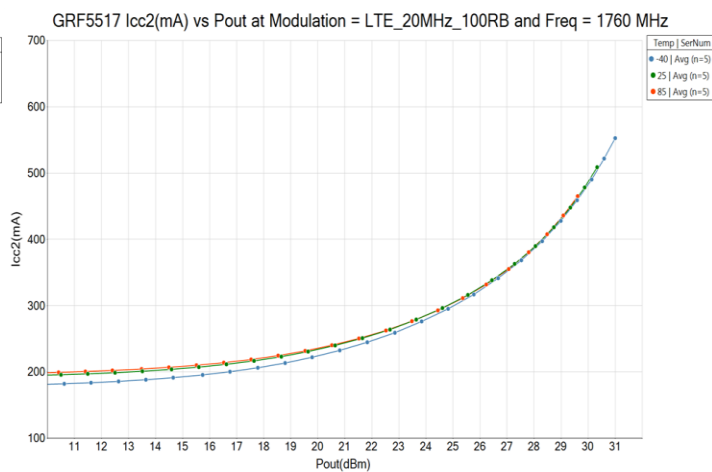
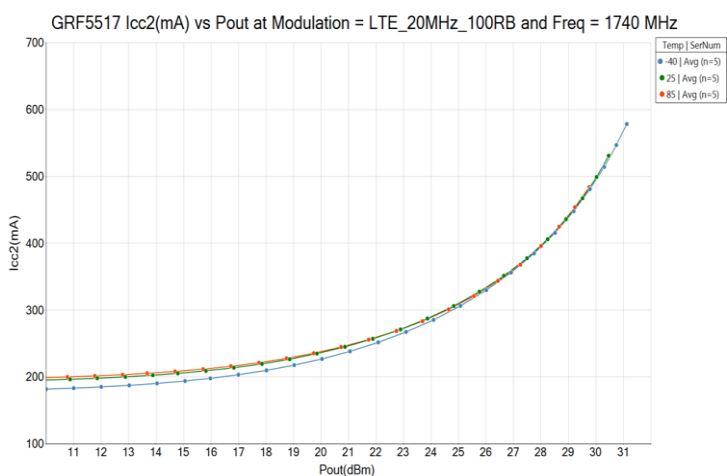
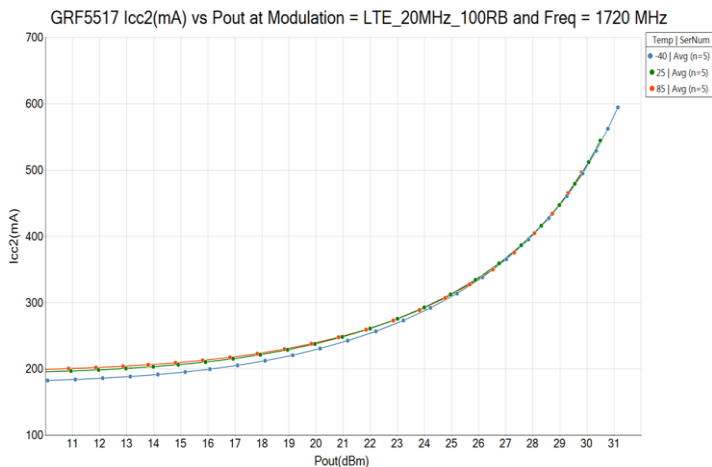
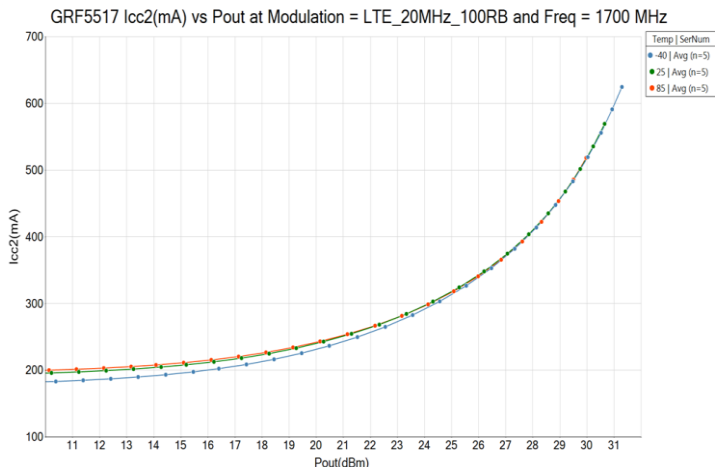

GRF5517 Typical Operating Curves: S-Parameters (1.7 to 1.8 GHz Tune)

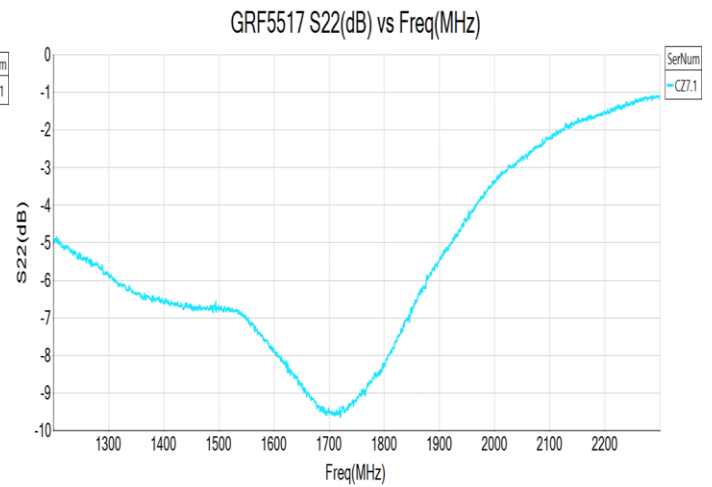
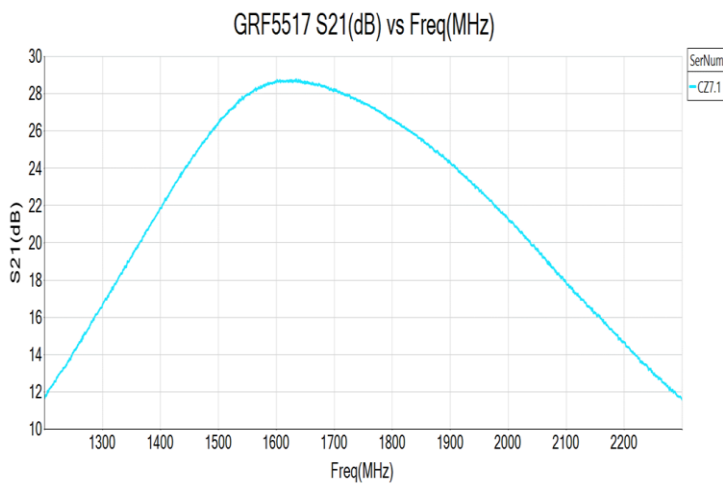
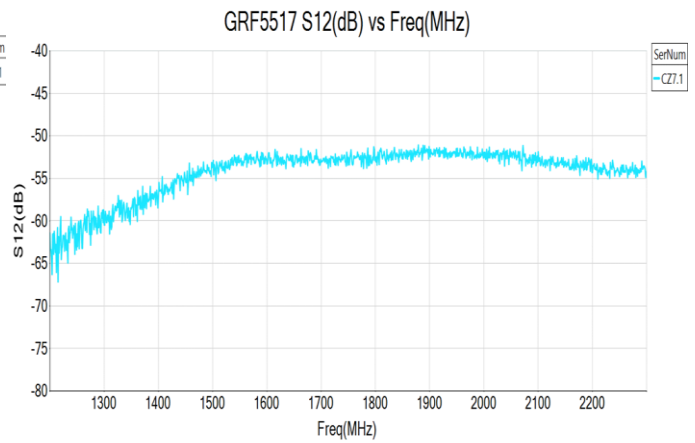
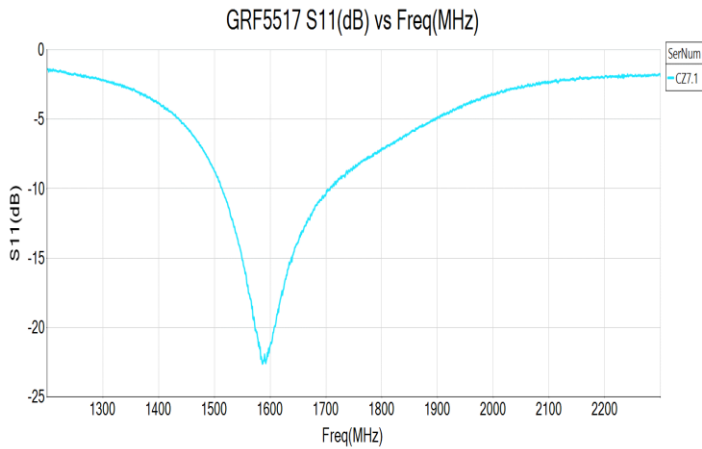

### GRF5517 Typical Operating Curves: S-Parameters (1.7 to 1.8 GHz Tune)

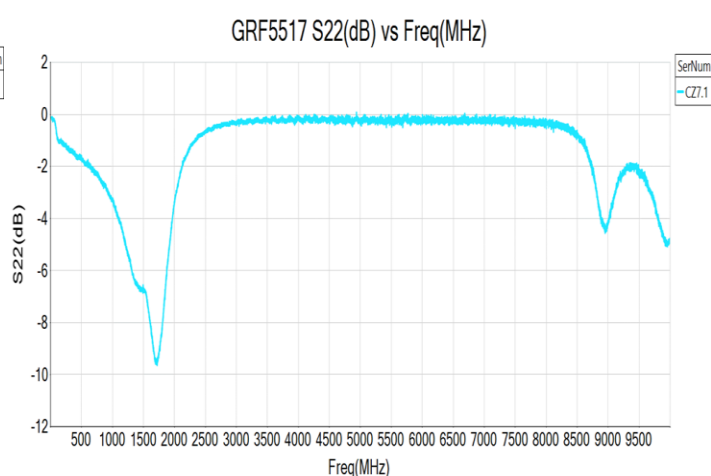
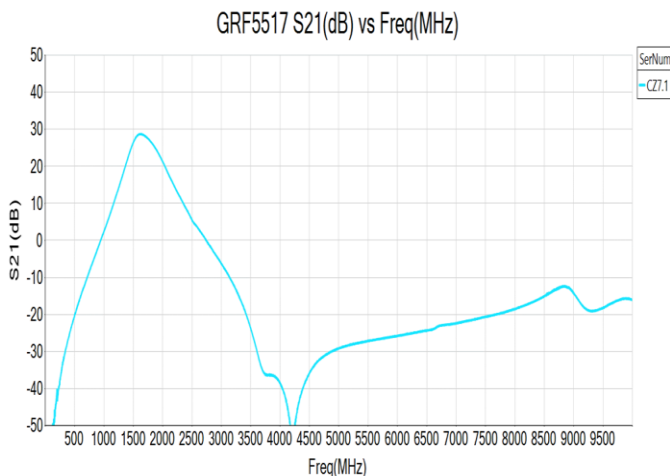
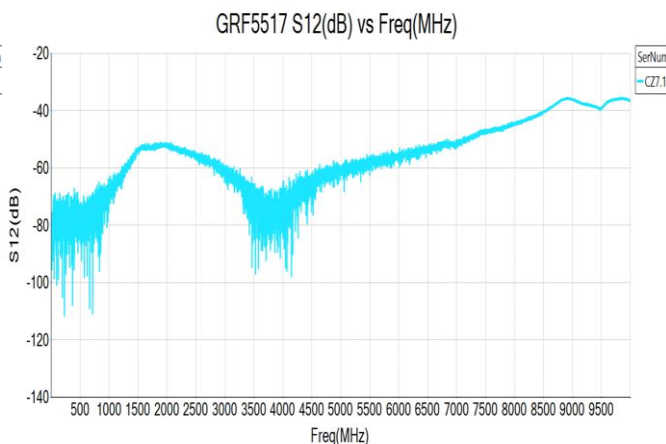
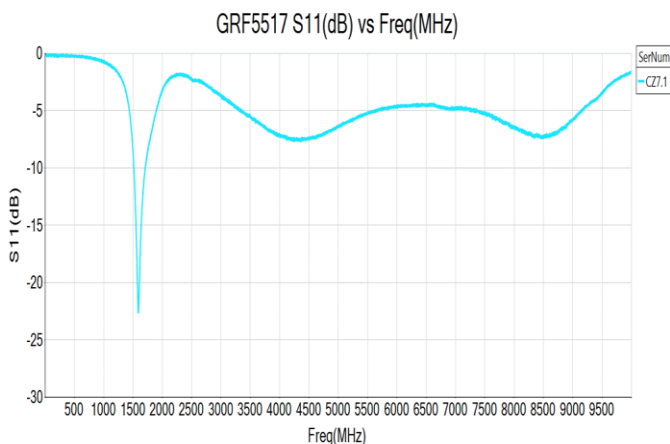

**GRF5517 Typical Operating Curves: Maximum Die Temperatures vs. Pout (85°C Reference Temperature on Standard Evaluation Board; CW Tone Input)**

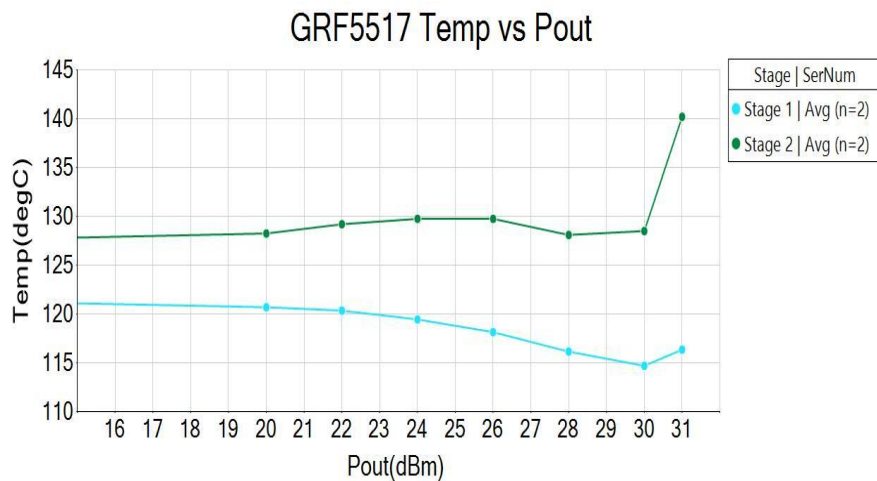

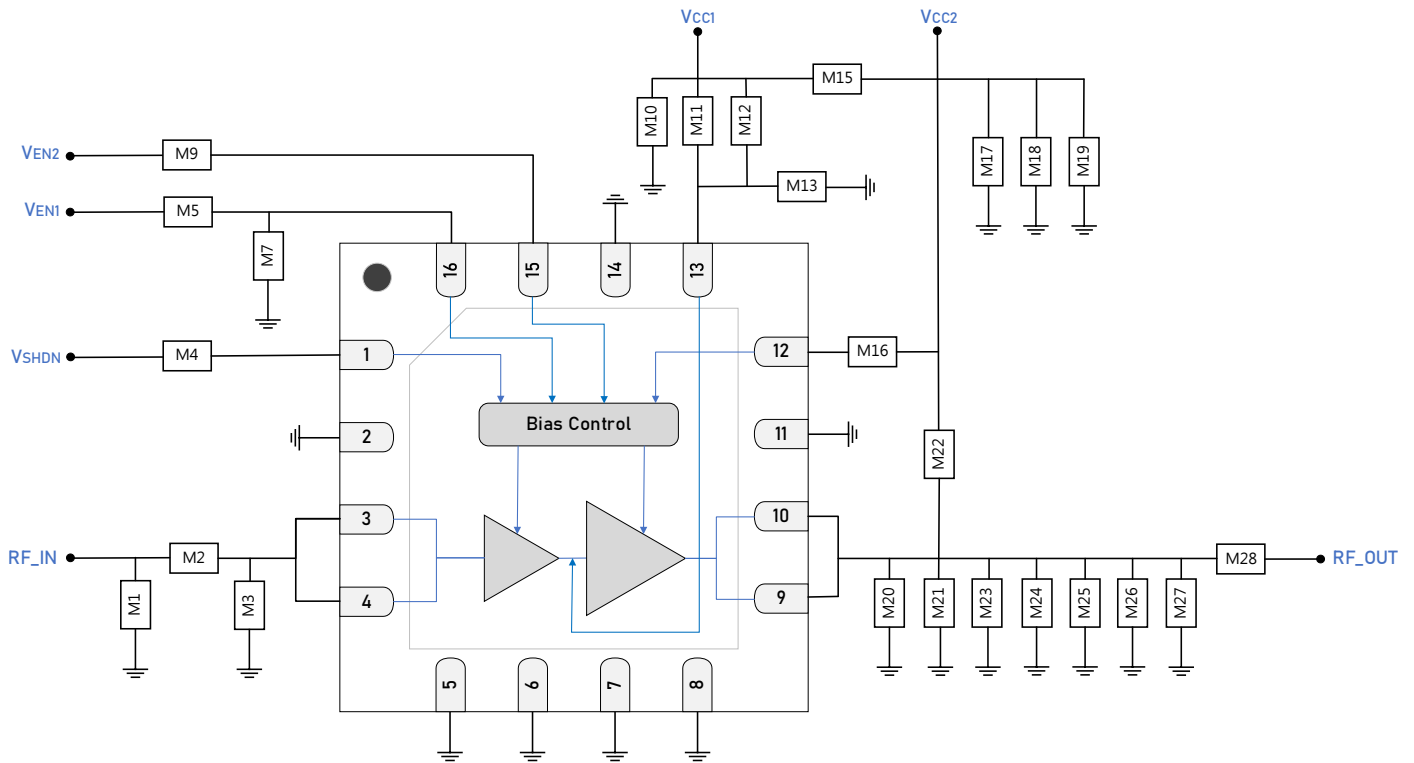

**GRF5517 Standard Evaluation Board Schematic**

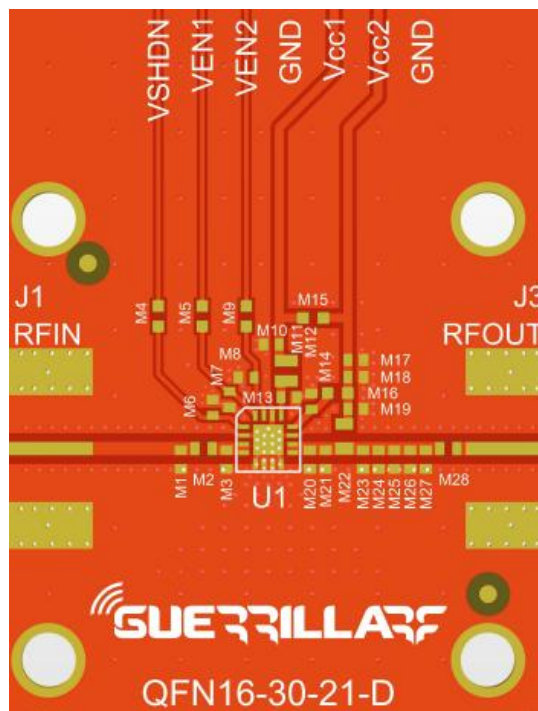

**GRF5517 Evaluation Board Assembly Diagram**

**GRF5517 Evaluation Board Assembly Diagram Reference: Standard (1.7 to 1.8 GHz Tune)**

Component	Type	Manufacturer	Family	Value	Package Size	Substitution
M1	Inductor	Murata	LQG	1.8 nH	0402	ok
M2	Capacitor	Murata	GJM	4.7 pF	0402	ok
M4, M11, M16	Resistor (jumper)	Various	5%	0 $\Omega$	0402	ok
M5	Resistor	Various	1%	2.26 k $\Omega$	0402	ok
M9	Resistor	Various	1%	2.94 k $\Omega$	0402	ok
M13	Capacitor	Murata	GRM	0.1 $\mu$ F	0402	ok
M15	Inductor	Murata	LQG	47 nH	0402	ok
M18	Capacitor	Murata	GRM	10 $\mu$ F	0402	ok
M22	Inductor: High Q	Murata	LQW	10 nH	0603	ok
M24	Capacitor	Murata	GJM	3.6 pF	0402	ok
M28	Capacitor	Murata	GJM	15 pF	0402	ok
M3, M6, M7, M8, M10, M12, M14, M17, M19, M20, M21, M23, M25, M26, M27	DNP					
Evaluation Board	QFN16-30-21-D					

**Note 4:** Standard evaluation board bias:  $V_{CC} = 5$  V,  $V_{ENABLE} = 5$  V.

**GRF5517 Evaluation Board Assembly Diagram Reference: Extended Bandwidth (1.71 to 1.92 GHz Tune)**

Component	Type	Manufacturer	Family	Value	Package Size	Substitution
M1	Inductor	Murata	LQG	2.2 nH	0402	ok
M2	Capacitor	Murata	GJM	2.4 pF	0402	ok
M4	Resistor (jumper)	Various	5%	0 $\Omega$	0402	ok
M5	Resistor	Various	1%	1.87 k $\Omega$	0402	ok
M9	Resistor	Various	1%	3.57 k $\Omega$	0402	ok
M11	Resistor (jumper)	Various	5%	0 $\Omega$	0402	ok
M13	Capacitor	Murata	GRM	0.1 $\mu$ F	0402	ok
M15	Inductor	Murata	LQG	47 nH	0402	ok
M16	Resistor	Various	5%	0 $\Omega$	0402	ok
M18	Capacitor	Murata	GJM	10 $\mu$ F	0402	ok
M22	Inductor: High Q	Murata	LQW	10 nH	0603	ok
M23	Capacitor	Murata	GJM	3.6 pF	0402	ok
M28	Capacitor	Murata	GJM	15 pF	0402	ok
M3, M6, M7, M8, M10, M12, M14, M17, M19, M20, M21, M24, M26, M27	DNP					
Evaluation Board	QFN16-30-21-D					

**Note 5:** Standard evaluation board bias:  $V_{CC} = 5$  V,  $V_{ENABLE} = 5$  V. Please consult with GRF Sales or GRF Applications Engineering for any additional extended bandwidth data.

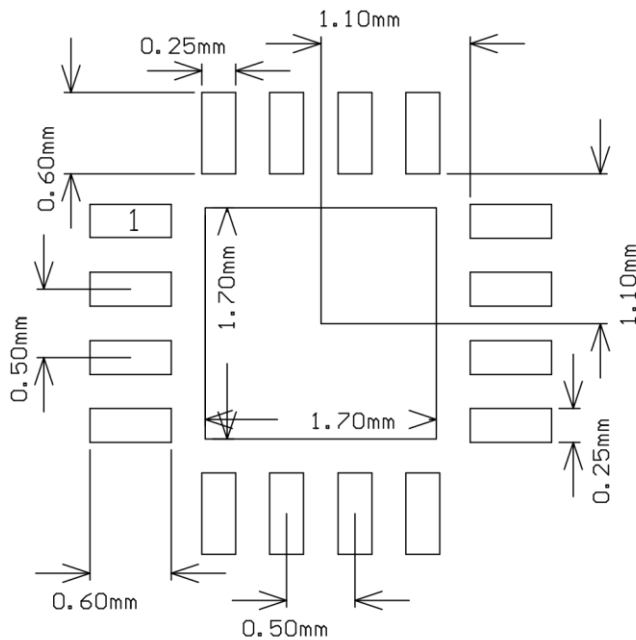

3 x 3 mm QFN-16 Suggested PCB Footprint (Top View)

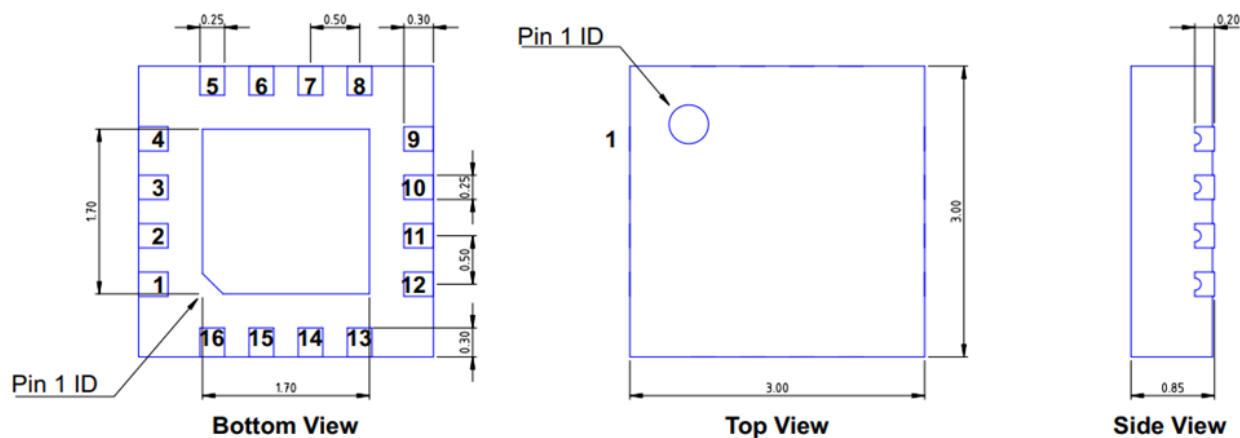

**QFN16 3x3mm**  
 Dimensions in millimeters  
 Dimensional Tolerance: ±0.05

3 x 3 mm QFN-16 Package Dimensions

### Package Marking Diagram



- Line 1: "YY" = YEAR. "WW" = WORK WEEK the device was assembled.
- Line 2: "GRF" = Guerrilla RF.
- Line 3: "XXXX" = Device PART NUMBER.

### Tape and Reel Information

Guerrilla RF's tape and reel specification complies with Electronic Industries Alliance (EIA) standards for "Embossed Carrier Tape of Surface Mount Components for Automatic Handling" (reference EIA-481). See the following page for the Tape and Reel Specification and Device Package Information table, which includes units per reel.

Devices are loaded with pins down into the carrier pocket with protective cover tape and reeled onto a plastic reel. Each reel is packaged in a cardboard box. There are product labels on the reel, the protective ESD bag and the outside surface of the box.

For the Tape and Reel Reference Table, please refer to: <https://www.guerrilla-rf.com/prodFiles/Manufacturing/MN001.pdf>

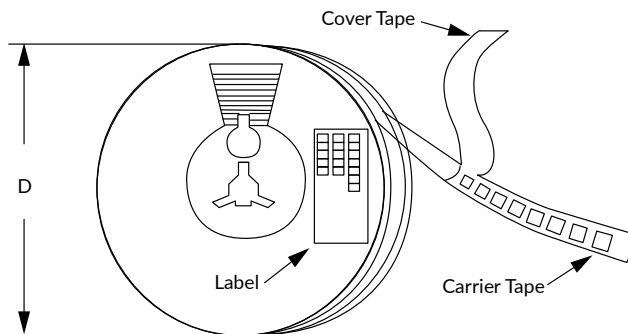

Tape and Reel Packaging with Reel Diameter Noted (D)

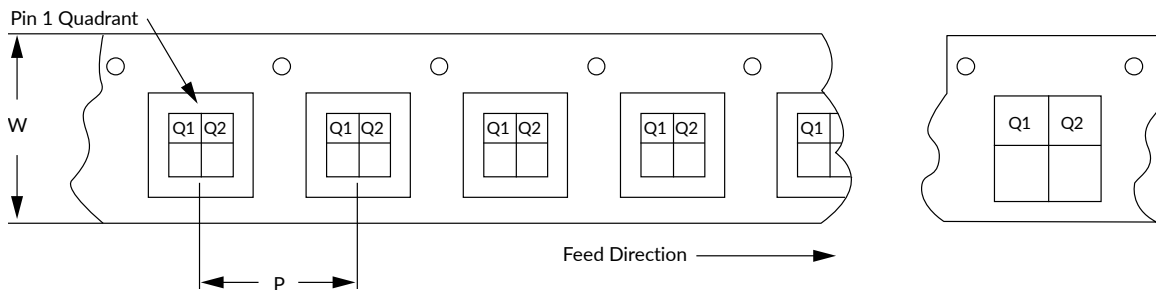

Carrier Tape Width (W), Pitch (P), Feed Direction and Pin 1 Quadrant Information

### Revision History

Revision Date	Description of Change
February 27, 2020	Preliminary Data Sheet.
March 17, 2021	Release Ø Data Sheet. Converted Data Sheet to new format. Added typical operating curves.
October 6, 2021	Added Output IMD3 Level Parameter to Nominal Operating Parameters Table. Added additional evaluation board BOM reference table for the 1.71 to 1.92 GHz tune.
March 8, 2022	Updated Package Marking Diagram.
January 24, 2023	Added the following condition to Maximum Dissipated Power for Stage 1 & 2: DC only (no RF applied).
September 10, 2023	Release A Data Sheet.
January 10, 2025	Updated Data Sheet with cosmetic changes only. No change to device or device specifications.
May 9, 2025	Changed frequency range from 1.7 - 1.8 GHz to 1.6 - 1.92 GHz.
May 21, 2025	Updated frequency of family of part numbers listed on page 1.
November 5, 2025	Updated evaluation board standard BOM.



### Data Sheet Classifications

Data Sheet Status	Notes
Advance	S-parameter and NF data based on EM simulations for the fully packaged device using foundry-supplied transistor S-parameters. Linearity estimates based on device size, bias condition and experience with related devices.
Preliminary	All data based on limited evaluation board measurements taken within the Guerrilla RF Applications Lab. All parametric values are subject to change pending the collection of additional data.
Release Ø	All data based on measurements taken with <i>production-released</i> material. TYP values are based on a combination of ATE and bench-level measurements, with MIN/MAX limits defined using <i>modelled estimates</i> that account for part-to-part variations and expected process spreads. Although unlikely, future refinements to the TYP/MIN/MAX values may be in order as multiple lots are processed through the factory.
Release A-Z	All data based on measurements taken with production-released material <i>derived from multiple lots which have been fabricated over an extended period of time</i> . MIN/MAX limits may be refined over previous releases as more statistically significant data is collected to account for process spreads.

Information in this data sheet is specific to the Guerrilla RF, Inc. ("Guerrilla RF") product identified.

This data sheet, including the information contained in it, is provided by Guerrilla RF as a service to its customers and may be used for informational purposes only by the customer. Guerrilla RF assumes no responsibility for errors or omissions on this data sheet or the information contained herein. Information provided is believed to be accurate and reliable, however, no responsibility is assumed by Guerrilla RF for its use, nor for any infringement of patents, or other rights of third parties, resulting from its use. Guerrilla RF assumes no liability for any data sheet, data sheet information, materials, products, product information, or other information provided hereunder, including the sale, distribution, reproduction or use of Guerrilla RF products, information or materials.

No license, whether express, implied, by estoppel, by implication or otherwise is granted by this data sheet for any intellectual property of Guerrilla RF, or any third party, including without limitation, patents, patent rights, copyrights, trademarks and trade secrets. All rights are reserved by Guerrilla RF.

All information herein, products, product information, data sheets, and data sheet information are subject to change and availability without notice. Guerrilla RF reserves the right to change component circuitry, recommended application circuitry and specifications at any time without prior notice. Guerrilla RF may further change its data sheet, product information, documentation, products, services, specifications or product descriptions at any time, without notice. Guerrilla RF makes no commitment to update any materials or information and shall have no responsibility whatsoever for conflicts, incompatibilities, or other difficulties arising from any future changes.

GUERRILLA RF INFORMATION, PRODUCTS, PRODUCT INFORMATION, DATA SHEETS AND DATA SHEET INFORMATION ARE PROVIDED "AS IS" AND WITHOUT WARRANTY OF ANY KIND, WHETHER EXPRESS, IMPLIED, STATUTORY, OR OTHERWISE, INCLUDING FITNESS FOR A PARTICULAR PURPOSE OR USE, MERCHANTABILITY, PERFORMANCE, QUALITY OR NON-INFRINGEMENT OF ANY INTELLECTUAL PROPERTY RIGHT; ALL SUCH WARRANTIES ARE HEREBY EXPRESSLY DISCLAIMED. GUERRILLA RF DOES NOT WARRANT THE ACCURACY OR COMPLETENESS OF THE INFORMATION, TEXT, GRAPHICS OR OTHER ITEMS CONTAINED WITHIN THESE MATERIALS. GUERRILLA RF SHALL NOT BE LIABLE FOR ANY DAMAGES, INCLUDING BUT NOT LIMITED TO ANY SPECIAL, INDIRECT, INCIDENTAL, STATUTORY, OR CONSEQUENTIAL DAMAGES, INCLUDING WITHOUT LIMITATION, LOST REVENUES OR LOST PROFITS THAT MAY RESULT FROM THE USE OF THE MATERIALS OR INFORMATION, WHETHER OR NOT THE RECIPIENT OF MATERIALS HAS BEEN ADVISED OF THE POSSIBILITY OF SUCH DAMAGE.

Customers are solely responsible for their use of Guerrilla RF products in the Customer's products and applications or in ways which deviate from Guerrilla RF's published specifications, either intentionally or as a result of design defects, errors, or operation of products outside of published parameters or design specifications. Customers should include design and operating safeguards to minimize these and other risks. Guerrilla RF assumes no liability or responsibility for applications assistance, customer product design, or damage to any equipment resulting from the use of Guerrilla RF products outside of stated published specifications or parameters.