

30V 14A N-Channel MOSFET

Features

- Advanced trench MOSFET technology
- Ultra-low on-resistance and gate-charge
- RoHS compliant
- 100% UIS tested
- 100% R_g tested
- DFN 2mmX2mmX0.6mm-6L Package

Applications

- Motor controllers
- DC-to-DC converters
- Battery-driven electronic products, electrical equipment and machines

General Description

Product Summary	
V _{DS}	30V
R _{DS(ON)}	5.5 mΩ (Typ.)@10V
	7.3 mΩ (Typ.)@4.5V
I _D	14A

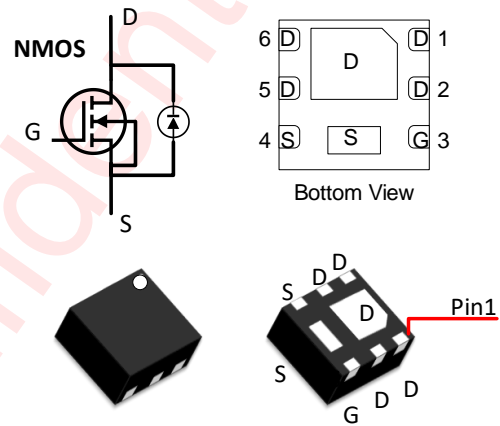

Pin Configuration and Top Mark

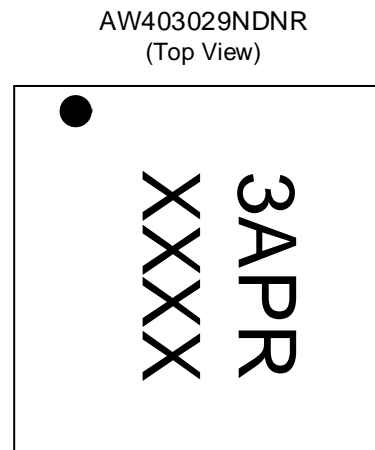
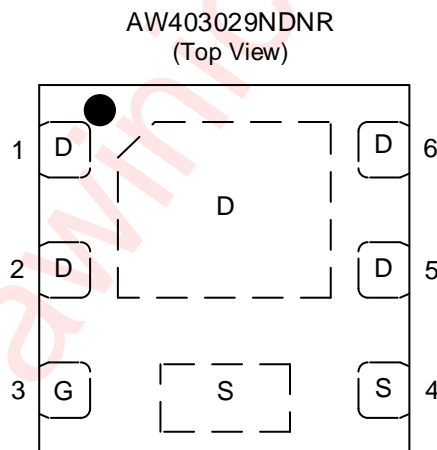

3APR-AW403029NDNR
XXXX-Production Tracing Code

Ordering Information

Part Number	Package	Marking	Moisture Sensitivity Level	Environmental Information	Delivery Form
AW403029NDNR	DFN 2mmX 2mmX0.6mm-6L	3APR	MSL1	RoHS+HF	3000 units/ Tape and Reel

Absolute Maximum Ratings (NOTE 1)

T_A= 25°C unless otherwise noted.

Symbol	Parameter	Maximum	Unit	
V _{DS}	Drain-Source Voltage	30	V	
V _{GS}	Gate-Source Voltage	±20	V	
I _D	Drain Current(DC) (NOTE 6)	T _A = 25°C	14	A
		T _A = 100°C	11	A
I _{DM}	Drain Current(Pulse) (NOTE 3)	56	A	
P _D	Power Dissipation (T _A = 25°C)	2.4	W	
T _J	Maximum Operating Junction Temperature	150	°C	
T _{STG}	Storage Temperature	-55 to 150	°C	
I _{AS}	Avalanche Current (NOTE 5)	21	A	
E _{AS}	Avalanche Energy (NOTE 5)	22	mJ	

Thermal Information

Symbol	Parameter	Condition	Value	Unit
R _{θJA}	Maximum Junction to Ambient (NOTE 2, 4)	Steady-State	52	°C/W

NOTE1: Conditions out of those ranges listed in "absolute maximum ratings" may cause permanent damages to the device. In spite of the limits above, functional operation conditions of the device should within the ranges listed in "recommended operating conditions". Exposure to absolute-maximum-rated conditions for prolonged periods may affect device reliability.

NOTE2: Mounted on FR-4 material with 1inch², 2oz. Copper.

NOTE3: Test condition 380μs 25°C.

NOTE4: Thermal resistance from junction to ambient is highly dependent on PCB layout.

NOTE5: L= 0.1mH, V_{GS}= 10V, R_g= 25Ω, V_{DS}= 15V.

NOTE6: Rated according to R_{θJA}.

Electrical Characteristics

T_J= 25°C for typical values (unless otherwise noted)

Symbol	Parameter	Test Condition	Min	Typ	Max	Unit
STATIC PARAMETERS						
B _V DSS	Drain-Source Breakdown Voltage	I _D = 250μA, V _{GS} = 0V	30	-	-	V
I _{DSS}	Zero Gate Voltage Drain Current	V _{DS} = 30V, V _{GS} = 0V	-	-	1	μA
I _{GSS}	Gate Leakage Current	V _{DS} = 0V, V _{GS} = ±20V	-	-	±100	nA
V _{GS(TH)}	Gate Threshold Voltage	V _{DS} = V _{GS} , I _D = 250μA	1.2	-	2.4	V
R _{DS(ON)}	Static Drain to Source On-Resistance	V _{GS} = 10V, I _D = 10A	-	5.5	7	mΩ
		V _{GS} = 4.5V, I _D = 10A	-	7.3	9.0	mΩ
g _{FS}	Forward Transconductance	V _{DS} = 5V, I _D = 10A	-	65	-	S
V _{SD}	Diode Forward Voltage	I _S = 1A, V _{GS} = 0V	-	0.7	-	V
DYNAMIC PARAMETERS						
R _g	Gate Resistance	f= 1MHz	-	2	-	Ω
C _{iss}	Input Capacitance	V _{GS} = 0V, V _{DS} = 15V, f= 1MHz	-	1530	-	pF
C _{oss}	Output Capacitance		-	150	-	pF
C _{rss}	Reverse Transfer Capacitance		-	120	-	pF
SWITCHING PARAMETERS						
Q _g	Total Gate Charge	V _{GS} = 10V, V _{DS} = 15V, I _D = 10A	-	28	-	nC
Q _{gs}	Gate Source Charge		-	4.5	-	nC
Q _{gd}	Gate Drain Charge		-	5	-	nC
t _{d(on)}	Turn-On Delay Time	V _{DS} = 15V, I _D = 10A, R _g = 3Ω, V _{GS} = 10V	-	6.5	-	ns
t _r	Turn-On Rise Time		-	3	-	ns
t _{d(off)}	Turn-Off Delay Time		-	25	-	ns
t _f	Turn-Off Fall Time		-	12	-	ns
t _{rr}	Body Diode Reverse Recovery Time	I _D = 10A, di/dt= 100A/μs	-	13.5	-	ns
Q _{rr}	Body Diode Reverse Recovery Charge	I _D = 10A, di/dt= 100A/μs	-	5.3	-	nC

Typical Electrical and Thermal Characteristics

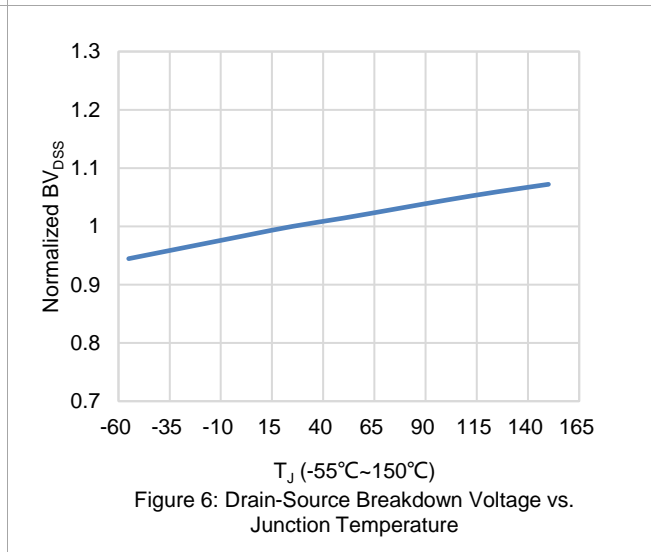
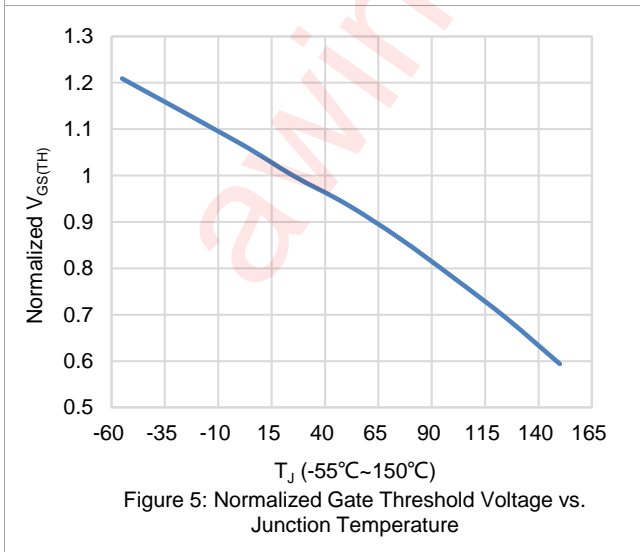
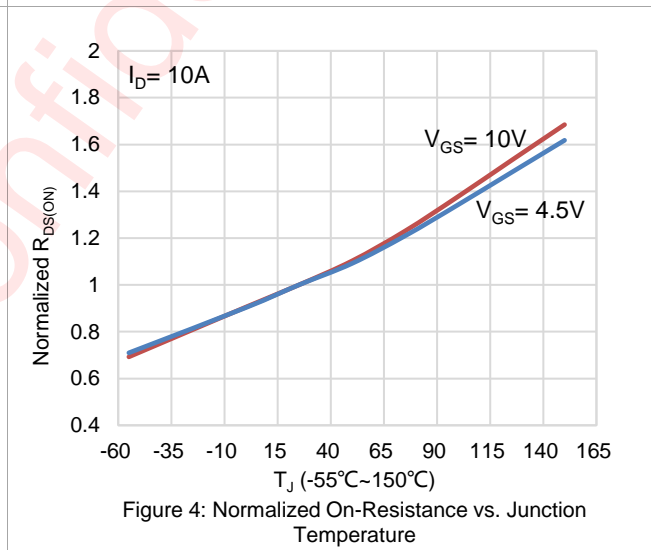
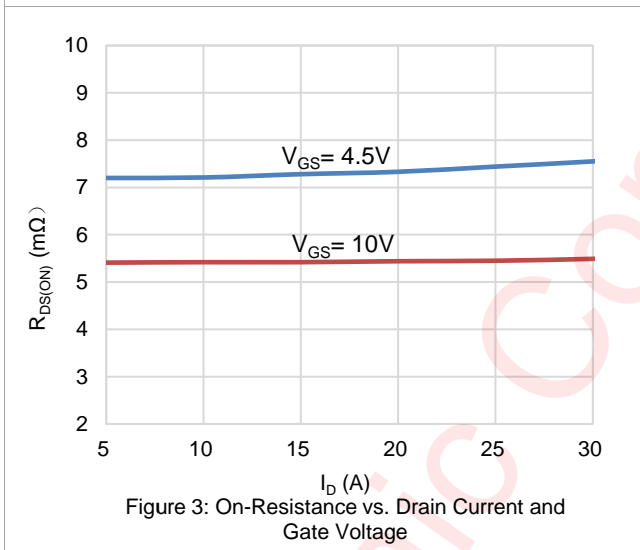
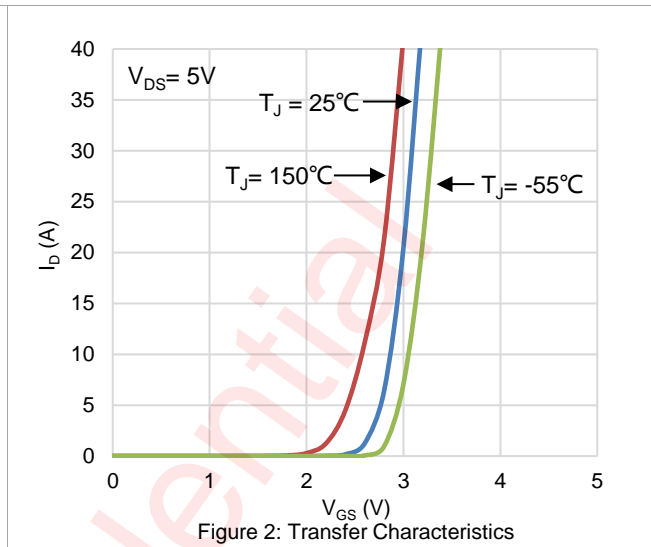
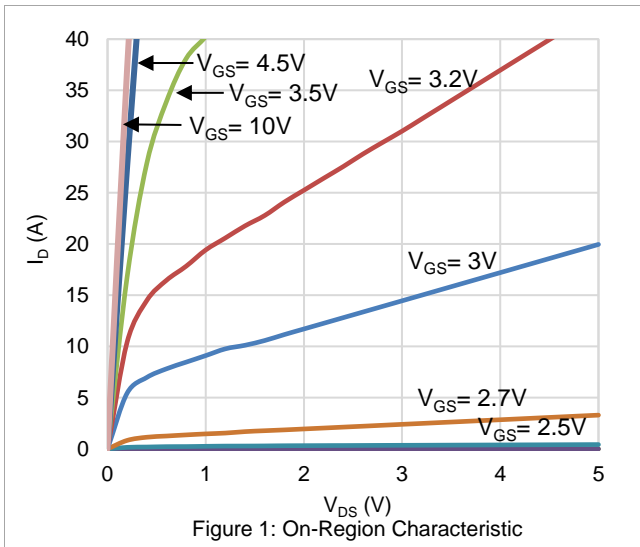

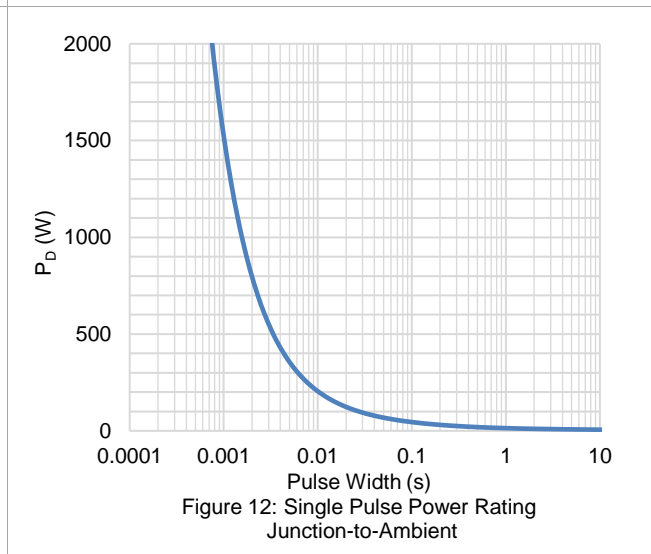
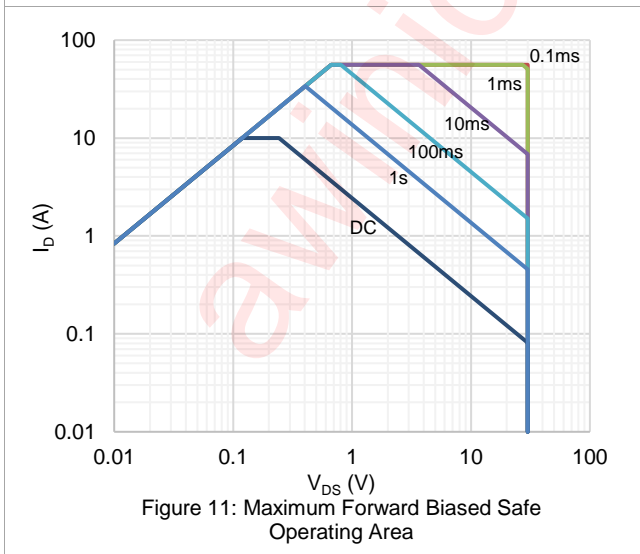
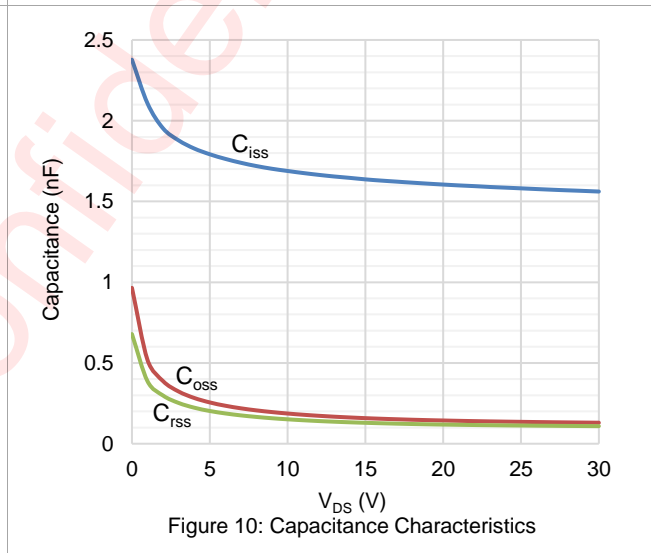
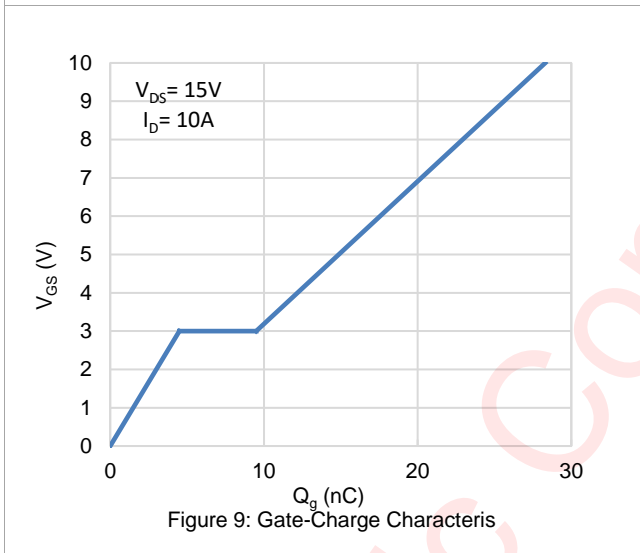
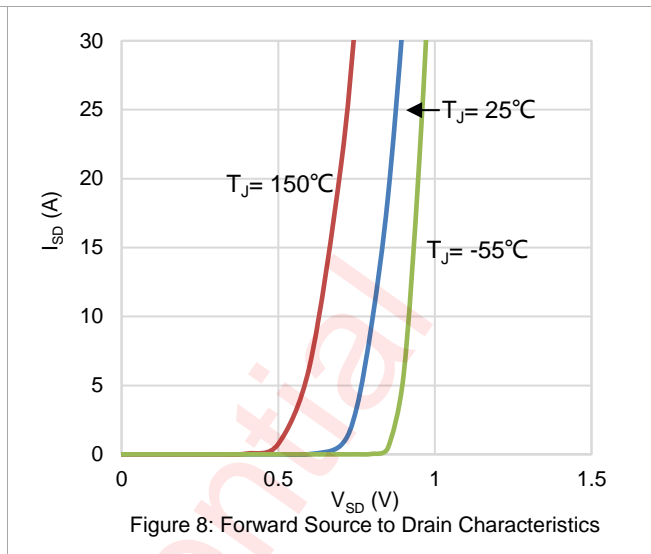
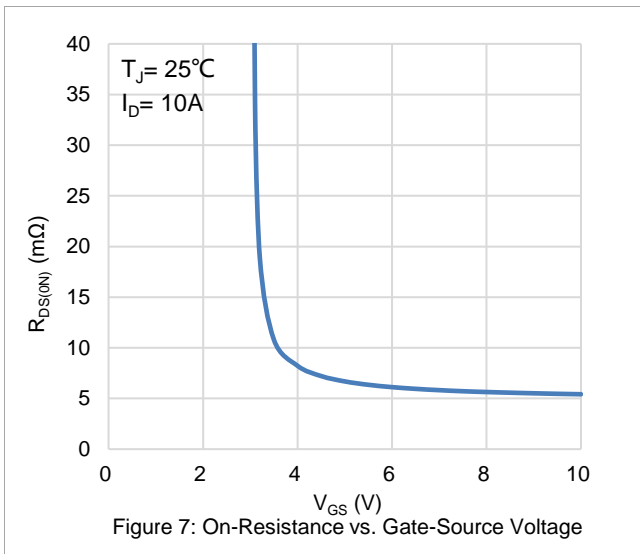

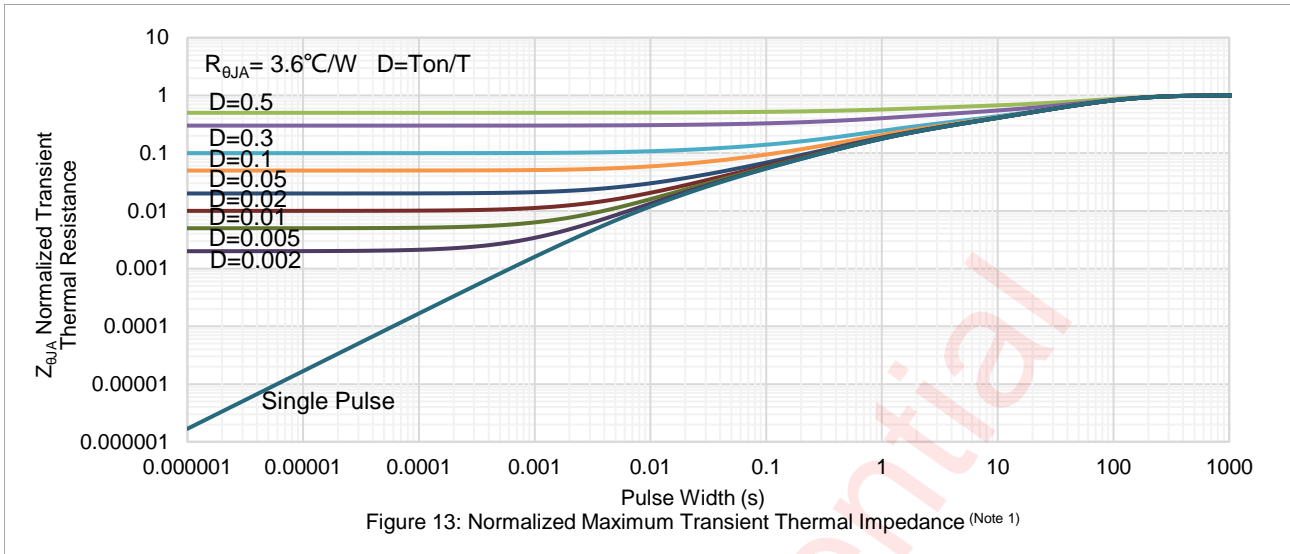

Tape And Reel Information

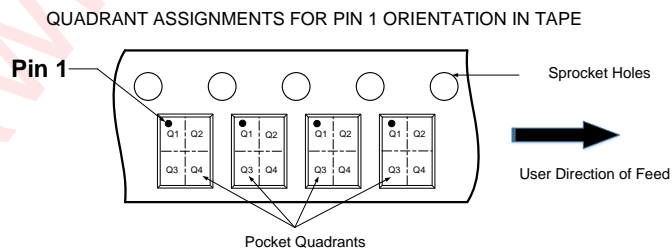
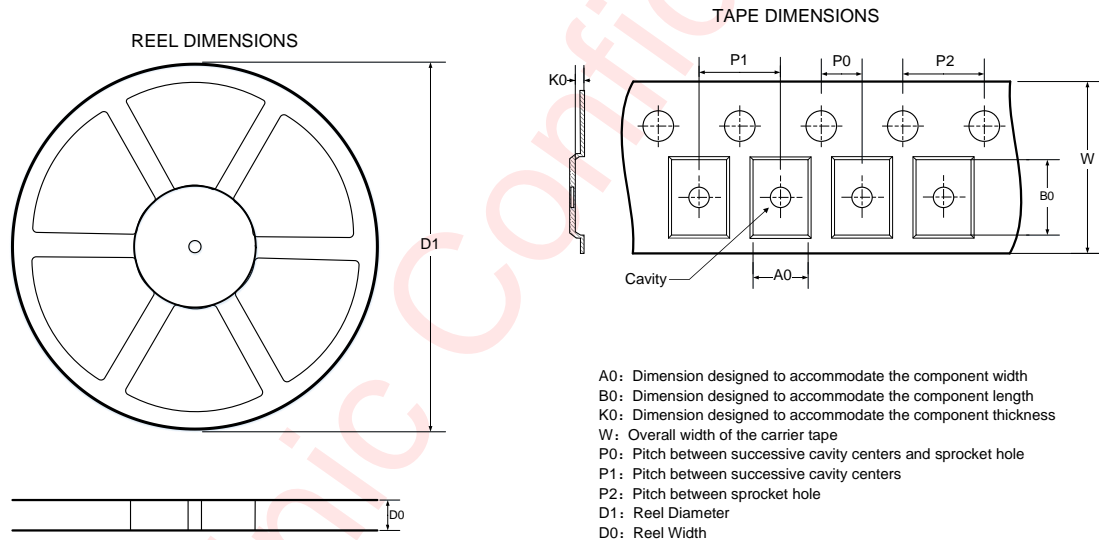

Note: The above picture is for reference only. Please refer to the value in the table below for the actual size

DIMENSIONS AND PIN1 ORIENTATION									
D1 (mm)	D0 (mm)	A0 (mm)	B0 (mm)	K0 (mm)	P0 (mm)	P1 (mm)	P2 (mm)	W (mm)	Pin1 Quadrant
178	8.4	2.25	2.25	0.75	2	4	4	8	Q1

All dimensions are nominal

Package Description

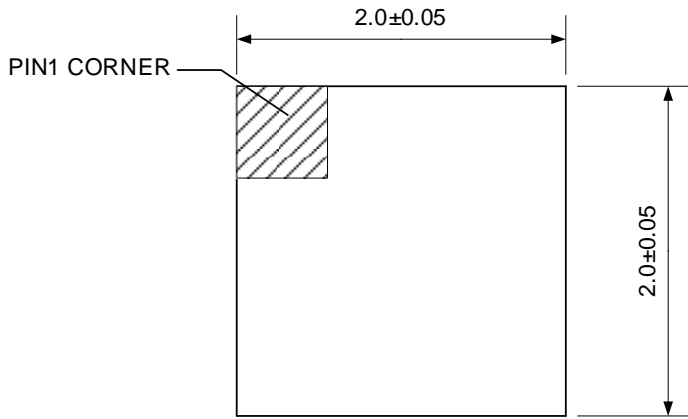

Top View

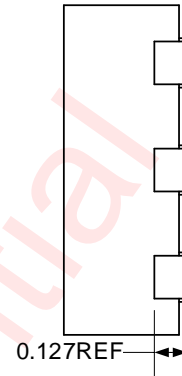

Side View

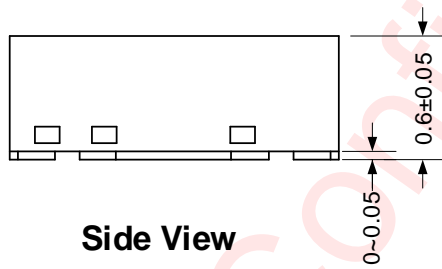

Side View

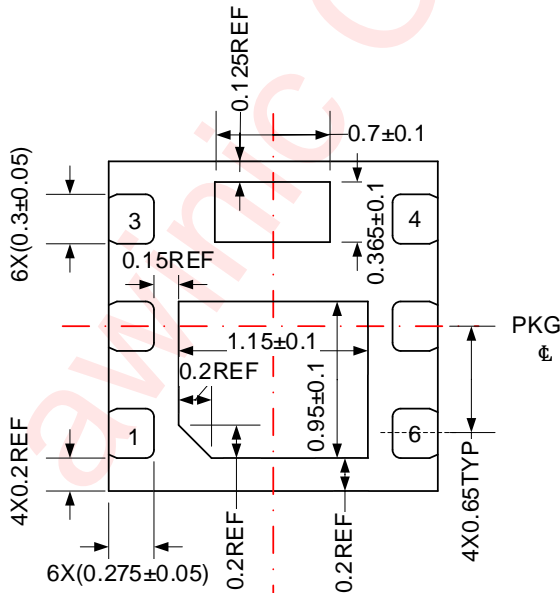

Bottom View

Unit: mm

Land Pattern Data

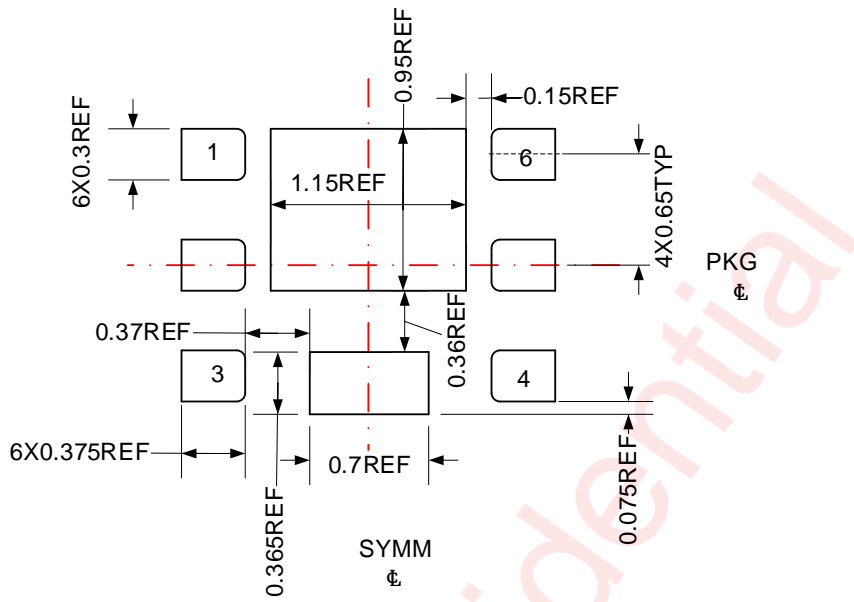

0.05 MAX
All AROUND

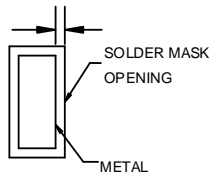

NON SOLDER MASK DEFINED

0.05 MIN
All AROUND

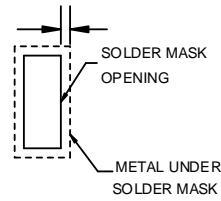

SOLDER MASK DEFINED

Unit: mm

Revision History

Version	Date	Change Record
V1.0	Nov. 2022	Official released

Disclaimer

All trademarks are the property of their respective owners. Information in this document is believed to be accurate and reliable. However, Shanghai AWINIC Technology Co., Ltd (AWINIC Technology) does not give any representations or warranties, expressed or implied, as to the accuracy or completeness of such information and shall have no liability for the consequences of use of such information.

AWINIC Technology reserves the right to make changes to information published in this document, including without limitation specifications and product descriptions, at any time and without notice. Customers shall obtain the latest relevant information before placing orders and shall verify that such information is current and complete. This document supersedes and replaces all information supplied prior to the publication hereof.

AWINIC Technology products are not designed, authorized or warranted to be suitable for use in medical, military, aircraft, space or life support equipment, nor in applications where failure or malfunction of an AWINIC Technology product can reasonably be expected to result in personal injury, death or severe property or environmental damage. AWINIC Technology accepts no liability for inclusion and/or use of AWINIC Technology products in such equipment or applications and therefore such inclusion and/or use is at the customer's own risk.

Applications that are described herein for any of these products are for illustrative purposes only. AWINIC Technology makes no representation or warranty that such applications will be suitable for the specified use without further testing or modification.

All products are sold subject to the general terms and conditions of commercial sale supplied at the time of order acknowledgement.

Nothing in this document may be interpreted or construed as an offer to sell products that is open for acceptance or the grant, conveyance or implication of any license under any copyrights, patents or other industrial or intellectual property rights.

Reproduction of AWINIC information in AWINIC data books or data sheets is permissible only if reproduction is without alteration and is accompanied by all associated warranties, conditions, limitations, and notices. AWINIC is not responsible or liable for such altered documentation. Information of third parties may be subject to additional restrictions.

Resale of AWINIC components or services with statements different from or beyond the parameters stated by AWINIC for that component or service voids all express and any implied warranties for the associated AWINIC component or service and is an unfair and deceptive business practice. AWINIC is not responsible or liable for any such statements.