

APPROVED: _____
 DATE: _____ TITLE: _____

Rev	AWO #	Description	Date	Appr
-		RELEASED	9/27/18	

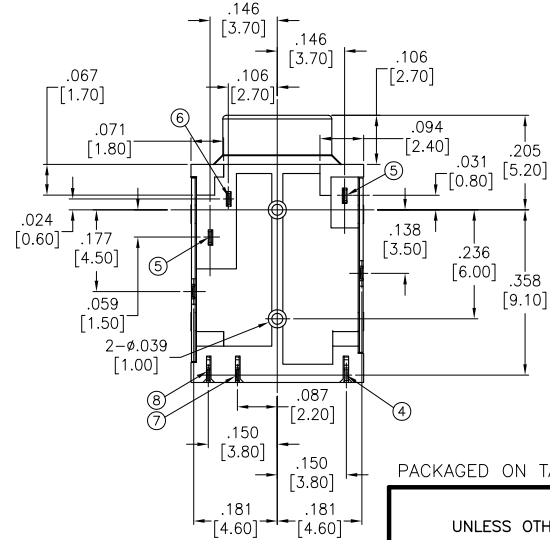

⑩ Mylar 2			
⑨ Mylar 1			
⑧ Make spring	6	Copper Alloy	Silver Plating
⑦ Transfer spring	5	Copper Alloy	
⑥ Earth spring	1	Copper Alloy	Sel-Gold Matte
⑤ Ring spring	3	Copper Alloy	Tin Plated
④ Tip spring	2	Copper Alloy	
③ Shell		Copper Alloy	Nickel Plating
② Separate		High-Temp Thermoplastic (Halogen Free)	BLACK
① Housing		High-Temp Thermoplastic (Halogen Free)	BLACK
NO.	DESCRIPTION	MATERIAL	REMARK

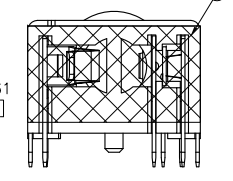
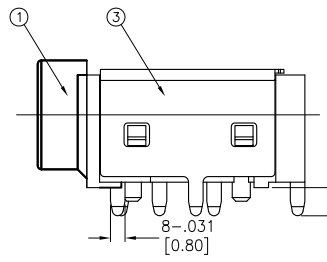
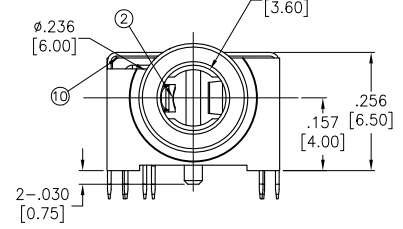
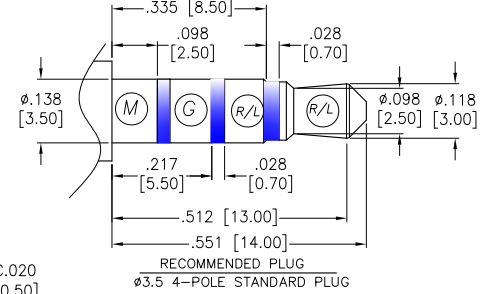
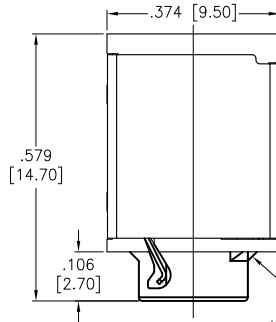
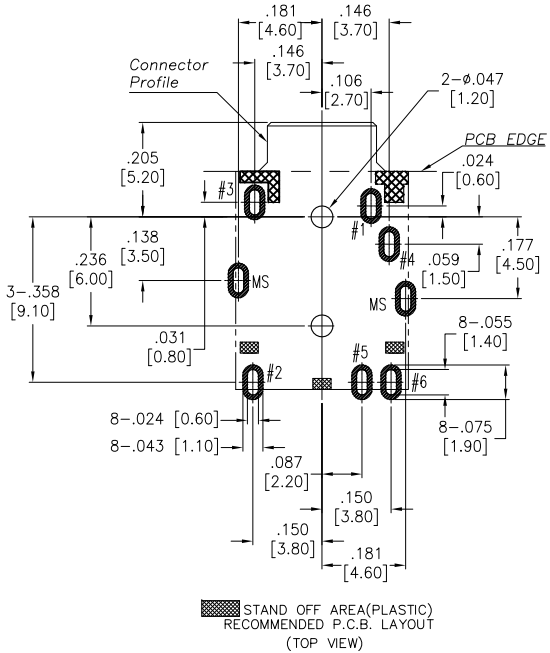
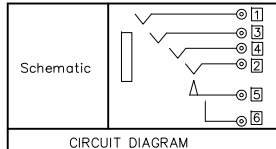

□ : TERMINAL NO.

SPECIFICATIONS:
 Electrical:
 Rating: 30V, 0.5A
 Contact resistance: 50 mohms max
 Insulation resistance: 100 Mohms min @ 500 VDC
 Dielectric withstanding voltage: 500 VAC
 Temperature Rating:
 Operating temperature: -20°C to +70°C
 Environmental:
 Lead free, RoHS compliant.



PACKAGED ON TAPE & REEL

UNLESS OTHERWISE SPECIFIED ALL DIMENSIONS ARE INCHES [MM] TOLERANCES: EXCEPT AS NOTED			
INCHES		HOLES	
.X	± .10	ø.X	± .10
.XX	± .020	ø.XX	± .015
.XXX	± .015	ø.XXX	± .010
APPROVALS		DATE	
DRAWN	AY	9/27/18	
CHECKED	MY	9/27/18	
APPROVED			

ADAM TECH INTERCONNECTS 909 Rahway Avenue, Union, NJ 07083 Phone: 908-687-5000 Fax: 908-687-5710

TITLE: STEREO JACK, 3.5MM, RIGHT ANGLE PCB MOUNT THRU HOLE

SIZE	PART NO.	REV.
X	ASJ-192-Y-T/R	-
REF: S00002C	SCALE: NTS	SHEET 1 OF 1