

## Dual-Channel, 14-/12-Bit, 160/125/65MSPS Ultralow-Power ADC

Check for Samples: [ADS4222](#), [ADS4225](#), [ADS4226](#), [ADS4242](#), [ADS4245](#), [ADS4246](#)

### FEATURES

- **Ultralow Power with Single 1.8V Supply, CMOS Output:**
  - 183mW total power at 65MSPS
  - 277mW total power at 125MSPS
  - 332mW total power at 160MSPS
- **High Dynamic Performance:**
  - 88dBc SFDR at 170MHz
  - 71.4dBFS SNR at 170MHz
- **Crosstalk: > 90dB at 185MHz**
- **Programmable Gain up to 6dB for SNR/SFDR Trade-off**
- **DC Offset Correction**
- **Output Interface Options:**
  - 1.8V parallel CMOS interface
  - Double data rate (DDR) LVDS with programmable swing:
    - Standard swing: 350mV
    - Low swing: 200mV
- **Supports Low Input Clock Amplitude Down to 200mV<sub>PP</sub>**
- **Package: QFN-64 (9mm × 9mm)**

### APPLICATIONS

- **Wireless Communications Infrastructure**
- **Software Defined Radio**
- **Power Amplifier Linearization**

### DESCRIPTION

The ADS424x/422x are low-speed variants of the ADS42xx ultralow-power family of dual-channel, 14-bit/12-bit analog-to-digital converters (ADCs). Innovative design techniques are used to achieve high-dynamic performance, while consuming extremely low power with 1.8V supply. This topology makes the ADS424x/422x well-suited for multi-carrier, wide-bandwidth communications applications.

The ADS424x/422x have gain options that can be used to improve SFDR performance at lower full-scale input ranges. These devices include a dc offset correction loop that can be used to cancel the ADC offset. Both DDR (double data rate) LVDS and parallel CMOS digital output interfaces are available in a compact QFN-64 PowerPAD™ package.

The devices include internal references while the traditional reference pins and associated decoupling capacitors have been eliminated. All devices are specified over the industrial temperature range (–40°C to +85°C).

### ADS424x/422x FAMILY COMPARISON<sup>(1)</sup>

	250MSPS	160MSPS	125MSPS	65MSPS
ADS424x 14-bit family	ADS4249	<a href="#">ADS4246</a>	<a href="#">ADS4245</a>	<a href="#">ADS4242</a>
ADS422x 12-bit family	ADS4229	<a href="#">ADS4226</a>	<a href="#">ADS4225</a>	<a href="#">ADS4222</a>

(1) See for details on migrating from the ADS62P49 family.

### PERFORMANCE SUMMARY

	ADS4246	ADS4245	ADS4242	ADS4226	ADS4225	ADS4222
SFDR (dBc), $f_{IN} = 20\text{MHz}$	86	88	91	86	88	91
SFDR (dBc), $f_{IN} = 170\text{MHz}$	82	88	85	82	88	85
SNR (dBFS), $f_{IN} = 20\text{MHz}$	72.8	73.4	73.6	70.5	70.8	70.9
SNR (dBFS), $f_{IN} = 170\text{MHz}$	70.4	71.4	71.2	69.5	69.9	69.9
Total power (mW/channel)	166	138	91	166	138	91



Please be aware that an important notice concerning availability, standard warranty, and use in critical applications of Texas Instruments semiconductor products and disclaimers thereto appears at the end of this data sheet.

PowerPAD is a trademark of Texas Instruments Incorporated.  
All other trademarks are the property of their respective owners.



This integrated circuit can be damaged by ESD. Texas Instruments recommends that all integrated circuits be handled with appropriate precautions. Failure to observe proper handling and installation procedures can cause damage.

ESD damage can range from subtle performance degradation to complete device failure. Precision integrated circuits may be more susceptible to damage because very small parametric changes could cause the device not to meet its published specifications.

**ORDERING INFORMATION<sup>(1)</sup>**

PRODUCT	PACKAGE-LEAD	PACKAGE DESIGNATOR	SPECIFIED TEMPERATURE RANGE	ECO PLAN <sup>(2)</sup>	LEAD/BALL FINISH	PACKAGE MARKING	ORDERING NUMBER	TRANSPORT MEDIA
ADS4246	QFN-64	RGC	-40°C to +85°C	GREEN (RoHS, no Sb/Br)	Cu/NiPdAu	AZ4246	ADS4246IRGCT	Tape and reel
							ADS4246IRGCR	Tape and reel
ADS4245	QFN-64	RGC	-40°C to +85°C	GREEN (RoHS, no Sb/Br)	Cu/NiPdAu	AZ4245	ADS4245IRGCT	Tape and reel
							ADS4245IRGCR	Tape and reel
ADS4242	QFN-64	RGC	-40°C to +85°C	GREEN (RoHS, no Sb/Br)	Cu/NiPdAu	AZ4242	ADS4242IRGCT	Tape and reel
							ADS4242IRGCR	Tape and reel
ADS4226	QFN-64	RGC	-40°C to +85°C	GREEN (RoHS, no Sb/Br)	Cu/NiPdAu	AZ4226	ADS4226IRGCT	Tape and reel
							ADS4226IRGCR	Tape and reel
ADS4225	QFN-64	RGC	-40°C to +85°C	GREEN (RoHS, no Sb/Br)	Cu/NiPdAu	AZ4225	ADS4225IRGCT	Tape and reel
							ADS4225IRGCR	Tape and reel
ADS4222	QFN-64	RGC	-40°C to +85°C	GREEN (RoHS, no Sb/Br)	Cu/NiPdAu	AZ4222	ADS4222IRGCT	Tape and reel
							ADS4222IRGCR	Tape and reel

- (1) For the most current package and ordering information, see the Package Option Addendum at the end of this document, or visit the device product folder at [www.ti.com](http://www.ti.com).
- (2) Eco Plan is the planned eco-friendly classification. Green (RoHS, no Sb/Br): TI defines Green to mean Pb-Free (RoHS compatible) and free of Bromine- (Br) and Antimony- (Sb) based flame retardants. Refer to the [Quality and Lead-Free \(Pb-Free\) Data](#) web site for more information.

The ADS424x/422x are pin-compatible with the previous generation ADS62P49 family of data converters; this architecture enables easy migration. However, there are some important differences between the two device generations, summarized in [Table 1](#).

**Table 1. Migrating from the ADS62P49**

ADS62P49 FAMILY	ADS424x/422x FAMILY
<b>PINS</b>	
Pin 22 is NC (not connected)	Pin 22 is AVDD
Pins 38 and 58 are DRVDD	Pins 38 and 58 are NC (do not connect, must be floated)
Pins 39 and 59 are DRGND	Pins 39 and 59 are NC (do not connect, must be floated)
<b>SUPPLY</b>	
AVDD is 3.3V	AVDD is 1.8V
DRVDD is 1.8V	No change
<b>INPUT COMMON-MODE VOLTAGE</b>	
VCM is 1.5V	VCM is 0.95V
<b>SERIAL INTERFACE</b>	
Protocol: 8-bit register address and 8-bit register data	No change in protocol New serial register map
<b>EXTERNAL REFERENCE</b>	
Supported	Not supported

**ABSOLUTE MAXIMUM RATINGS<sup>(1)</sup>**

		ADS424x/422x		UNIT
		MIN	MAX	
Supply voltage range, AVDD		-0.3	2.1	V
Supply voltage range, DRVDD		-0.3	2.1	V
Voltage between AGND and DRGND		-0.3	0.3	V
Voltage between AVDD to DRVDD (when AVDD leads DRVDD)		-2.4	2.4	V
Voltage between DRVDD to AVDD (when DRVDD leads AVDD)		-2.4	2.4	V
Voltage applied to input pins	INP_A, INM_A, INP_B, INM_B	-0.3	Minimum (1.9, AVDD + 0.3)	V
	CLKP, CLKM <sup>(2)</sup>	-0.3	AVDD + 0.3	V
	RESET, SCLK, SDATA, SEN, CTRL1, CTRL2, CTRL3	-0.3	3.9	V
Operating free-air temperature range, T <sub>A</sub>		-40	+85	°C
Operating junction temperature range, T <sub>J</sub>			+125	°C
Storage temperature range, T <sub>stg</sub>		-65	+150	°C
ESD rating	Human body model (HBM)		2	kV

- (1) Stresses above these ratings may cause permanent damage. Exposure to absolute maximum conditions for extended periods may degrade device reliability. These are stress ratings only, and functional operation of the device at these or any other conditions beyond those specified is not implied.
- (2) When AVDD is turned off, it is recommended to switch off the input clock (or ensure the voltage on CLKP, CLKM is less than |0.3V|). This configuration prevents the ESD protection diodes at the clock input pins from turning on.

**THERMAL INFORMATION**

THERMAL METRIC <sup>(1)</sup>		ADS42xx	UNITS
		RGC	
		64 PINS	
θ <sub>JA</sub>	Junction-to-ambient thermal resistance	23.9	°C/W
θ <sub>JCtop</sub>	Junction-to-case (top) thermal resistance	10.9	
θ <sub>JB</sub>	Junction-to-board thermal resistance	4.3	
ψ <sub>JT</sub>	Junction-to-top characterization parameter	0.1	
ψ <sub>JB</sub>	Junction-to-board characterization parameter	4.4	
θ <sub>JCbot</sub>	Junction-to-case (bottom) thermal resistance	0.6	

- (1) For more information about traditional and new thermal metrics, see the *IC Package Thermal Metrics* application report, [SPRA953](#).

## RECOMMENDED OPERATING CONDITIONS

Over operating free-air temperature range, unless otherwise noted.

PARAMETER	ADS424x/422x			UNIT	
	MIN	NOM	MAX		
<b>SUPPLIES</b>					
Analog supply voltage, AVDD	1.7	1.8	1.9	V	
Digital supply voltage, DRVDD	1.7	1.8	1.9	V	
<b>ANALOG INPUTS</b>					
Differential input voltage range	2			V <sub>PP</sub>	
Input common-mode voltage	VCM ± 0.05			V	
Maximum analog input frequency with 2V <sub>PP</sub> input amplitude <sup>(1)</sup>	400			MHz	
Maximum analog input frequency with 1V <sub>PP</sub> input amplitude <sup>(1)</sup>	600			MHz	
<b>CLOCK INPUT</b>					
<b>Input clock sample rate (ADS4242/ADS4222)</b>					
Low-speed mode enabled (by default after reset)	1		65	MSPS	
<b>Input clock sample rate (ADS4245/ADS4225)</b>					
Low-speed mode enabled <sup>(2)</sup>	1		80	MSPS	
Low-speed mode disabled <sup>(2)</sup> (by default after reset)	80		125	MSPS	
<b>Input clock sample rate (ADS4246/ADS4226)</b>					
Low-speed mode enabled <sup>(2)</sup>	1		80	MSPS	
Low-speed mode disabled <sup>(2)</sup> (by default after reset)	80		160	MSPS	
Input clock amplitude differential (V <sub>CLKP</sub> – V <sub>CLKM</sub> )	Sine wave, ac-coupled		0.2	1.5	V <sub>PP</sub>
	LVPECL, ac-coupled				V <sub>PP</sub>
	LVDS, ac-coupled				V <sub>PP</sub>
	LVCMOS, single-ended, ac-coupled				V
<b>Input clock duty cycle</b>					
Low-speed mode disabled	35	50	65	%	
Low-speed mode enabled	40	50	60	%	
<b>DIGITAL OUTPUTS</b>					
Maximum external load capacitance from each output pin to DRGND, C <sub>LOAD</sub>	5			pF	
Differential load resistance between the LVDS output pairs (LVDS mode), R <sub>LOAD</sub>	100			Ω	
Operating free-air temperature, T <sub>A</sub>	–40		+85	°C	

(1) See the [Theory of Operation](#) section in the Application Information.

(2) See the [Serial Interface Configuration](#) section for details on programming the low-speed mode.

### HIGH-PERFORMANCE MODES<sup>(1)(2)</sup>

PARAMETER	DESCRIPTION
High-performance mode	Set the HIGH PERF MODE register bit to obtain best performance across sample clock and input signal frequencies. Register address = 03h, data = 03h
High-frequency mode	Set the HIGH FREQ MODE CH A and HIGH FREQ MODE CH B register bits for high input signal frequencies greater than 200MHz. Register address = 4Ah, data = 01h Register address = 58h, data = 01h

(1) It is recommended to use these modes to obtain best performance.

(2) See the [Serial Interface Configuration](#) section for details on register programming.

**ELECTRICAL CHARACTERISTICS: ADS4246/ADS4245/ADS4242**

Typical values are at +25°C, AVDD = 1.8V, DRVDD = 1.8V, 50% clock duty cycle, –1dBFS differential analog input, LVDS interface, and 0dB gain, unless otherwise noted. Minimum and maximum values are across the full temperature range:

T<sub>MIN</sub> = –40°C to T<sub>MAX</sub> = +85°C, AVDD = 1.8V, and DRVDD = 1.8V.

PARAMETER	TEST CONDITIONS	ADS4246 (160MSPS)			ADS4245 (125MSPS)			ADS4242 (65MSPS)			UNIT
		MIN	TYP	MAX	MIN	TYP	MAX	MIN	TYP	MAX	
Resolution				14			14			14	Bits
Signal-to-noise ratio	SNR	f <sub>IN</sub> = 20MHz		72.8			73.4			73.6	dBFS
		f <sub>IN</sub> = 70MHz		72.5		70	72.9		69.5	72.5	dBFS
		f <sub>IN</sub> = 100MHz		72.2			72.6			72.3	dBFS
		f <sub>IN</sub> = 170MHz	69	71.2			71.4			70.4	dBFS
		f <sub>IN</sub> = 300MHz		69.4			69.3			69.4	dBFS
Signal-to-noise and distortion ratio	SINAD	f <sub>IN</sub> = 20MHz		72.6			73.2			73.5	dBFS
		f <sub>IN</sub> = 70MHz		72.1		69	72.6		68.5	72.3	dBFS
		f <sub>IN</sub> = 100MHz		71.7			72.3			72.1	dBFS
		f <sub>IN</sub> = 170MHz	67.5	70.8			71.2			70.2	dBFS
		f <sub>IN</sub> = 300MHz		68			68.5			68.2	dBFS
Spurious-free dynamic range	SFDR	f <sub>IN</sub> = 20MHz		86			88			91	dBc
		f <sub>IN</sub> = 70MHz		84		73.5	86		73.5	88	dBc
		f <sub>IN</sub> = 100MHz		82			85			87	dBc
		f <sub>IN</sub> = 170MHz	72	82			88			85	dBc
		f <sub>IN</sub> = 300MHz		78			78			74	dBc
Total harmonic distortion	THD	f <sub>IN</sub> = 20MHz		84			86			88	dBc
		f <sub>IN</sub> = 70MHz		81		72	84		72	85	dBc
		f <sub>IN</sub> = 100MHz		81			83			85	dBc
		f <sub>IN</sub> = 170MHz	70	80			84			82	dBc
		f <sub>IN</sub> = 300MHz		76			75			73	dBc
Second-harmonic distortion	HD2	f <sub>IN</sub> = 20MHz		86			88			91	dBc
		f <sub>IN</sub> = 70MHz		84		73.5	86		73.5	88	dBc
		f <sub>IN</sub> = 100MHz		82			85			87	dBc
		f <sub>IN</sub> = 170MHz	72	82			88			85	dBc
		f <sub>IN</sub> = 300MHz		78			78			74	dBc
Third-harmonic distortion	HD3	f <sub>IN</sub> = 20MHz		92			93			95	dBc
		f <sub>IN</sub> = 70MHz		86		73.5	89		73.5	90	dBc
		f <sub>IN</sub> = 100MHz		93			89			96	dBc
		f <sub>IN</sub> = 170MHz	72	94			90			87	dBc
		f <sub>IN</sub> = 300MHz		80			81			81	dBc
Worst spur (other than second and third harmonics)		f <sub>IN</sub> = 20MHz		90			95			98	dBc
		f <sub>IN</sub> = 70MHz		92		78	94		79	97	dBc
		f <sub>IN</sub> = 100MHz		89			93			95	dBc
		f <sub>IN</sub> = 170MHz	77	89			91			93	dBc
		f <sub>IN</sub> = 300MHz		91			89			92	dBc
Two-tone intermodulation distortion	IMD	f <sub>1</sub> = 46MHz, f <sub>2</sub> = 50MHz, each tone at –7dBFS		96			96			98	dBFS
		f <sub>1</sub> = 185MHz, f <sub>2</sub> = 190MHz, each tone at –7dBFS		83			92			92	dBFS

**ELECTRICAL CHARACTERISTICS: ADS4246/ADS4245/ADS4242 (continued)**

Typical values are at +25°C, AVDD = 1.8V, DRVDD = 1.8V, 50% clock duty cycle, –1dBFS differential analog input, LVDS interface, and 0dB gain, unless otherwise noted. Minimum and maximum values are across the full temperature range: T<sub>MIN</sub> = –40°C to T<sub>MAX</sub> = +85°C, AVDD = 1.8V, and DRVDD = 1.8V.

PARAMETER	TEST CONDITIONS	ADS4246 (160MSPS)			ADS4245 (125MSPS)			ADS4242 (65MSPS)			UNIT
		MIN	TYP	MAX	MIN	TYP	MAX	MIN	TYP	MAX	
Crosstalk	20-MHz full-scale signal on channel under observation; 170-MHz full-scale signal on other channel		95			95			95		dB
Input overload recovery	Recovery to within 1% (of full-scale) for 6dB overload with sine-wave input		1			1			1		Clock cycle
AC power-supply rejection ratio	PSRR For 100mV <sub>pp</sub> signal on AVDD supply, up to 10MHz		> 30			> 30			> 30		dB
Effective number of bits	ENOB $f_{IN} = 70\text{MHz}$ (ADS4245, ADS4242) $f_{IN} = 170\text{MHz}$ (ADS4246)		11.5			11.5			11.4		LSBs
Differential nonlinearity	DNL $f_{IN} = 70\text{MHz}$ (ADS4245, ADS4242) $f_{IN} = 170\text{MHz}$ (ADS4246)	–0.97	±0.5	1.7	–0.97	±0.5	1.7	–0.97	±0.5	1.7	LSBs
Integrated nonlinearity	INL $f_{IN} = 70\text{MHz}$ (ADS4245, ADS4242) $f_{IN} = 170\text{MHz}$ (ADS4246)		±2	±5		±2	±5		±2	±5	LSBs

**ELECTRICAL CHARACTERISTICS: ADS4226/ADS4225/ADS4222**

Typical values are at +25°C, AVDD = 1.8V, DRVDD = 1.8V, 50% clock duty cycle, –1dBFS differential analog input, LVDS interface, and 0dB gain, unless otherwise noted. Minimum and maximum values are across the full temperature range:

T<sub>MIN</sub> = –40°C to T<sub>MAX</sub> = +85°C, AVDD = 1.8V, and DRVDD = 1.8V.

PARAMETER	TEST CONDITIONS	ADS4226 (160MSPS)			ADS4225 (125MSPS)			ADS4222 (65MSPS)			UNIT
		MIN	TYP	MAX	MIN	TYP	MAX	MIN	TYP	MAX	
Resolution				12			12			12	Bits
Signal-to-noise ratio	SNR	f <sub>IN</sub> = 20MHz		70.5			70.8			70.9	dBFS
		f <sub>IN</sub> = 70MHz		70.3		68.0	70.5		68.0	70.3	dBFS
		f <sub>IN</sub> = 100MHz		70.1			70.3			70.2	dBFS
		f <sub>IN</sub> = 170MHz	67.5	69.5			69.9			69.9	dBFS
		f <sub>IN</sub> = 300MHz		68.2			68.1			68.2	dBFS
Signal-to-noise and distortion ratio	SINAD	f <sub>IN</sub> = 20MHz		70.4			70.7			70.8	dBFS
		f <sub>IN</sub> = 70MHz		70.1		67.0	70.3		67.0	70.2	dBFS
		f <sub>IN</sub> = 100MHz		69.8			70.1			70.1	dBFS
		f <sub>IN</sub> = 170MHz	66.5	69.3			69.5			68.7	dBFS
		f <sub>IN</sub> = 300MHz		67.6			67.5			67.2	dBFS
Spurious-free dynamic range	SFDR	f <sub>IN</sub> = 20MHz		86			88			91	dBc
		f <sub>IN</sub> = 70MHz		84		72.5	86		72.5	88	dBc
		f <sub>IN</sub> = 100MHz		82			85			87	dBc
		f <sub>IN</sub> = 170MHz	70	82			88			85	dBc
		f <sub>IN</sub> = 300MHz		78			78			74	dBc
Total harmonic distortion	THD	f <sub>IN</sub> = 20MHz		84			86			88	dBc
		f <sub>IN</sub> = 70MHz		81		70.0	84		71.0	85	dBc
		f <sub>IN</sub> = 100MHz		81			83			85	dBc
		f <sub>IN</sub> = 170MHz	68	80			84			82	dBc
		f <sub>IN</sub> = 300MHz		76			75			73	dBc
Second-harmonic distortion	HD2	f <sub>IN</sub> = 20MHz		86			88			91	dBc
		f <sub>IN</sub> = 70MHz		84		72.5	86		72.5	88	dBc
		f <sub>IN</sub> = 100MHz		82			85			87	dBc
		f <sub>IN</sub> = 170MHz	70	82			88			85	dBc
		f <sub>IN</sub> = 300MHz		78			78			74	dBc
Third-harmonic distortion	HD3	f <sub>IN</sub> = 20MHz		92			93			95	dBc
		f <sub>IN</sub> = 70MHz		86		72.5	89		72.5	90	dBc
		f <sub>IN</sub> = 100MHz		93			89			96	dBc
		f <sub>IN</sub> = 170MHz	70	94			90			87	dBc
		f <sub>IN</sub> = 300MHz		80			81			81	dBc
Worst spur (other than second and third harmonics)		f <sub>IN</sub> = 20MHz		90			95			98	dBc
		f <sub>IN</sub> = 70MHz		92		76.0	94		77.0	97	dBc
		f <sub>IN</sub> = 100MHz		89			93			95	dBc
		f <sub>IN</sub> = 170MHz	75	89			91			93	dBc
		f <sub>IN</sub> = 300MHz		91			89			92	dBc
Two-tone intermodulation distortion	IMD	f <sub>1</sub> = 46MHz, f <sub>2</sub> = 50MHz, each tone at –7dBFS		96			96			98	dBFS
		f <sub>1</sub> = 185MHz, f <sub>2</sub> = 190MHz, each tone at –7dBFS		83			92			92	dBFS

**ELECTRICAL CHARACTERISTICS: ADS4226/ADS4225/ADS4222 (continued)**

Typical values are at +25°C, AVDD = 1.8V, DRVDD = 1.8V, 50% clock duty cycle, –1dBFS differential analog input, LVDS interface, and 0dB gain, unless otherwise noted. Minimum and maximum values are across the full temperature range: T<sub>MIN</sub> = –40°C to T<sub>MAX</sub> = +85°C, AVDD = 1.8V, and DRVDD = 1.8V.

PARAMETER	TEST CONDITIONS	ADS4226 (160MSPS)			ADS4225 (125MSPS)			ADS4222 (65MSPS)			UNIT
		MIN	TYP	MAX	MIN	TYP	MAX	MIN	TYP	MAX	
Crosstalk	20MHz full-scale signal on channel under observation; 170MHz full-scale signal on other channel		95			95			95		dB
Input overload recovery	Recovery to within 1% (of full-scale) for 6dB overload with sine-wave input		1			1			1		Clock cycle
AC power-supply rejection ratio	PSRR For 100mV <sub>pp</sub> signal on AVDD supply, up to 10MHz		30			30			30		dB
Effective number of bits	ENOB $f_{IN} = 70\text{MHz}$ (ADS4225, ADS4222) $f_{IN} = 170\text{MHz}$ (ADS4226)		11.2			11.3			11.1		LSBs
Differential nonlinearity	DNL $f_{IN} = 70\text{MHz}$ (ADS4225, ADS4222) $f_{IN} = 170\text{MHz}$ (ADS4226)	–0.8	±0.13	1.5	–0.8	±0.13	1.5	–0.8	±0.13	1.2	LSBs
Integrated nonlinearity	INL $f_{IN} = 70\text{MHz}$ (ADS4225, ADS4222) $f_{IN} = 170\text{MHz}$ (ADS4226)		±0.5	±3.5		±0.5	±3.5		±0.5	±2.5	LSBs

## ELECTRICAL CHARACTERISTICS: GENERAL

Typical values are at +25°C, AVDD = 1.8V, DRVDD = 1.8V, 50% clock duty cycle, and –1dBFS differential analog input, unless otherwise noted. Minimum and maximum values are across the full temperature range: T<sub>MIN</sub> = –40°C to T<sub>MAX</sub> = +85°C, AVDD = 1.8V, and DRVDD = 1.8V.

PARAMETER	ADS4246/ADS4226 (160MSPS)			ADS4245/ADS4225 (125MSPS)			ADS4242/ADS4222 (65MSPS)			UNIT
	MIN	TYP	MAX	MIN	TYP	MAX	MIN	TYP	MAX	
<b>ANALOG INPUTS</b>										
Differential input voltage range (0dB gain)	2			2			2			V <sub>PP</sub>
Differential input resistance (at 200MHz)	0.75			0.75			0.75			kΩ
Differential input capacitance (at 200MHz)	3.7			3.7			3.7			pF
Analog input bandwidth (with 50Ω source impedance, and 50Ω termination)	550			550			550			MHz
Analog input common-mode current (per input pin of each channel)	1.5			1.5			1.5			μA/MSPS
Common-mode output voltage VCM	0.95			0.95			0.95			V
VCM output current capability	4			4			4			mA
<b>DC ACCURACY</b>										
Offset error	–15	2.5	15	–15	2.5	15	–15	2.5	15	mV
Temperature coefficient of offset error	0.003			0.003			0.003			mV/°C
Gain error as a result of internal reference inaccuracy alone E <sub>GREF</sub>	–2	2		–2	2		–2	2		%FS
Gain error of channel alone E <sub>GCHAN</sub>	±0.1		–1	±0.1		–1	±0.1		–1	%FS
Temperature coefficient of E <sub>GCHAN</sub>	0.002			0.002			0.002			Δ%/°C
<b>POWER SUPPLY</b>										
IAVDD Analog supply current	123		150	105		130	73		85	mA
IDRVDD Output buffer supply current LVDS interface, 350mV swing with 100Ω external termination, f <sub>IN</sub> = 2.5MHz	111		135	99		120	78		95	mA
IDRVDD Output buffer supply current CMOS interface, no load capacitance <sup>(1)</sup> f <sub>IN</sub> = 2.5MHz	61			49			28			mA
Analog power	222			189			133			mW
Digital power LVDS interface, 350mV swing with 100Ω external termination, f <sub>IN</sub> = 2.5MHz	199			179			131			mW
Digital power CMOS interface, no load capacitance <sup>(1)</sup> f <sub>IN</sub> = 2.5MHz	109			88			50			mW
Global power-down	25			25			25			mW

- (1) In CMOS mode, the DRVDD current scales with the sampling frequency, the load capacitance on output pins, input frequency, and the supply voltage (see the [CMOS Interface Power Dissipation](#) section in the [Application Information](#)).

## DIGITAL CHARACTERISTICS

At AVDD = 1.8V and DRVDD = 1.8V, unless otherwise noted. DC specifications refer to the condition where the digital outputs do not switch, but are permanently at a valid logic level '0' or '1'.

PARAMETER	TEST CONDITIONS	ADS424x/422x			UNIT	
		MIN	TYP	MAX		
<b>DIGITAL INPUTS (RESET, SCLK, SDATA, SEN, CTRL1, CTRL2, CTRL3)<sup>(1)</sup></b>						
High-level input voltage	All digital inputs support 1.8V and 3.3V CMOS logic levels	1.3			V	
Low-level input voltage		0.4			V	
High-level input current	SDATA, SCLK <sup>(2)</sup>	$V_{HIGH} = 1.8V$			$\mu A$	
	SEN <sup>(3)</sup>	$V_{HIGH} = 1.8V$			$\mu A$	
Low-level input current	SDATA, SCLK	$V_{LOW} = 0V$			$\mu A$	
	SEN	$V_{LOW} = 0V$			$\mu A$	
<b>DIGITAL OUTPUTS, CMOS INTERFACE (DA[13:0], DB[13:0], CLKOUT, SDOUT)</b>						
High-level output voltage		DRVDD – 0.1	DRVDD		V	
Low-level output voltage			0	0.1	V	
Output capacitance (internal to device)					pF	
<b>DIGITAL OUTPUTS, LVDS INTERFACE</b>						
High-level output differential voltage	$V_{ODH}$	With an external 100 $\Omega$ termination	270	350	430	mV
Low-level output differential voltage	$V_{ODL}$	With an external 100 $\Omega$ termination	–430	–350	–270	mV
Output common-mode voltage	$V_{OCM}$		0.9	1.05	1.25	V

- (1) SCLK, SDATA, and SEN function as digital input pins in serial configuration mode.
- (2) SDATA, SCLK have internal 150k $\Omega$  pull-down resistor.
- (3) SEN has an internal 150k $\Omega$  pull-up resistor to AVDD. Because the pull-up is weak, SEN can also be driven by 1.8V or 3.3V CMOS buffers.

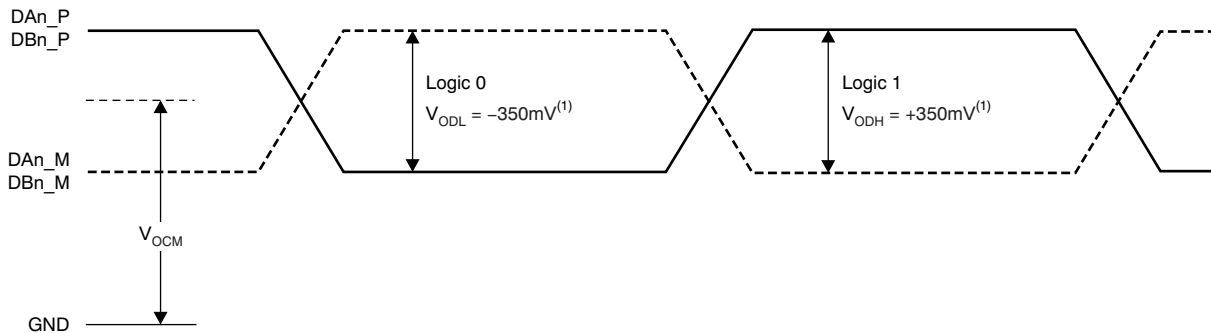

- (1) With external 100 $\Omega$  termination.

**Figure 1. LVDS Output Voltage Levels**

**PIN CONFIGURATION: LVDS MODE**

RGC PACKAGE<sup>(2)</sup>  
QFN-64  
(TOP VIEW)

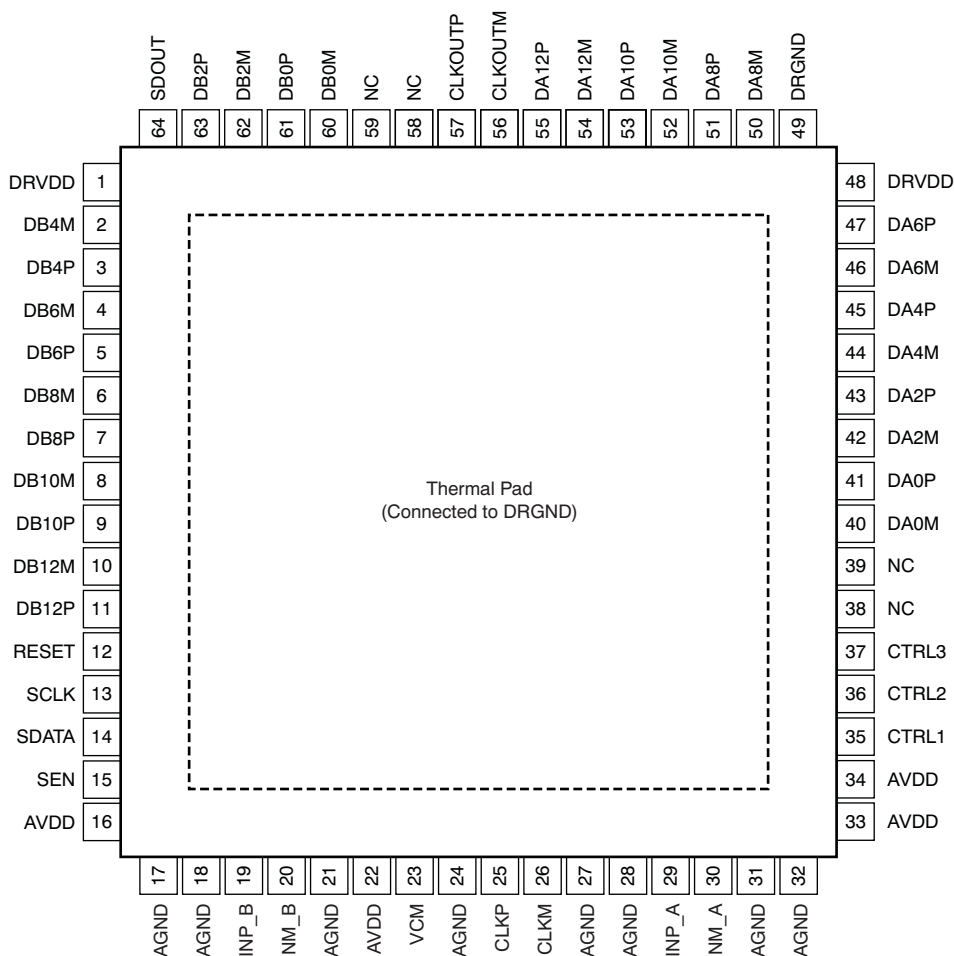

(2) The PowerPAD is connected to DRGND.

NOTE: NC = do not connect; must float.

**Figure 2. ADS4246/ADS4245/ADS4242 LVDS Mode**

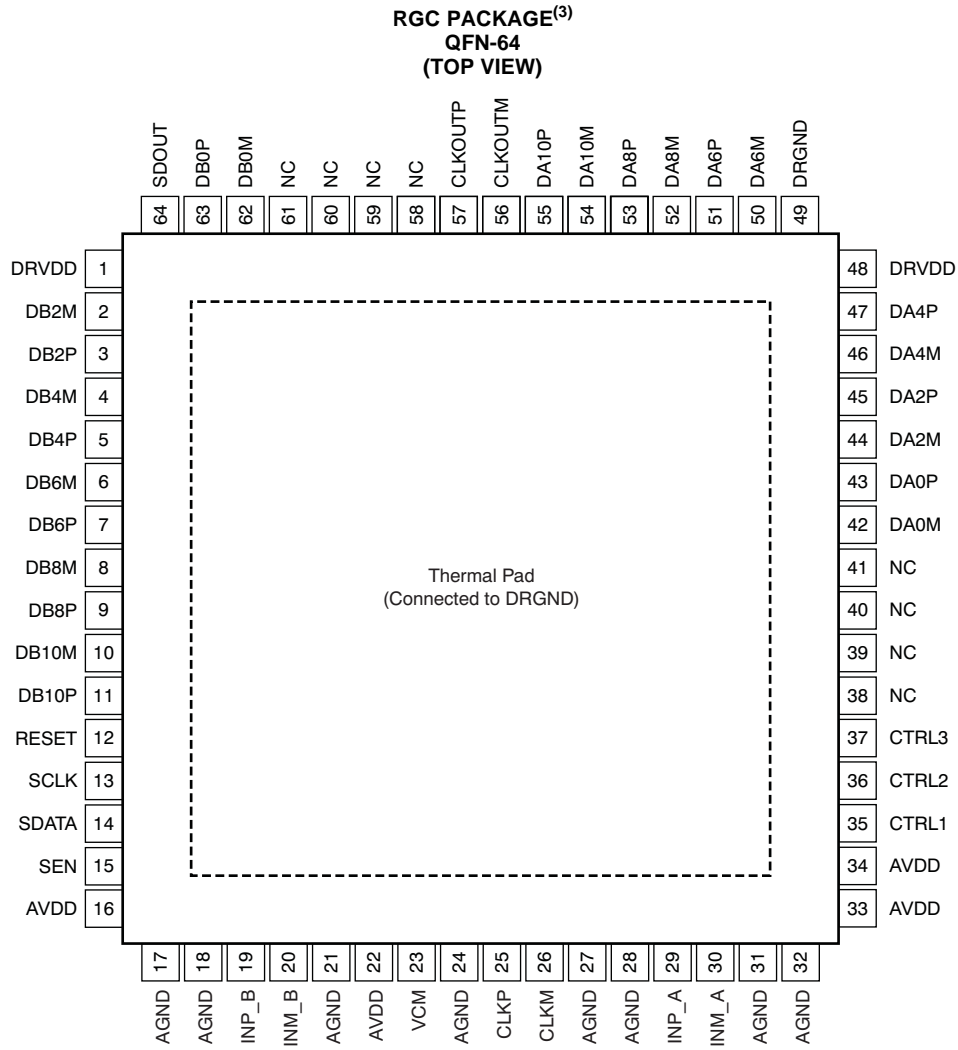

(3) The PowerPAD is connected to DRGND.

NOTE: NC = do not connect; must float.

**Figure 3. ADS4226/ADS4225/ADS4222 LVDS Mode**

**Pin Descriptions: LVDS Mode**

PIN NUMBER	PIN NAME	# OF PINS	FUNCTION	DESCRIPTION
1, 48	DRVDD	2	Input	Output buffer supply
12	RESET	1	Input	Serial interface RESET input. When using the serial interface mode, the internal registers must be initialized through a hardware RESET by applying a high pulse on this pin or by using the software reset option; refer to the <a href="#">Serial Interface Configuration</a> section. In parallel interface mode, the RESET pin must be permanently tied high. SCLK and SEN are used as parallel control pins in this mode. This pin has an internal 150kΩ pull-down resistor.
13	SCLK	1	Input	This pin functions as a serial interface clock input when RESET is low. It controls the low-speed mode selection when RESET is tied high; see <a href="#">Table 5</a> for detailed information. This pin has an internal 150kΩ pull-down resistor.
14	SDATA	1	Input	Serial interface data input; this pin has an internal 150kΩ pull-down resistor.
15	SEN	1	Input	This pin functions as a serial interface enable input when RESET is low. It controls the output interface and data format selection when RESET is tied high; see <a href="#">Table 6</a> for detailed information. This pin has an internal 150kΩ pull-up resistor to AVDD.
16, 22, 33, 34	AVDD	4	Input	Analog power supply
17, 18, 21, 24, 27, 28, 31, 32	AGND	8	Input	Analog ground
19	INP_B	1	Input	Differential analog positive input, channel B
20	INM_B	1	Input	Differential analog negative input, channel B
23	VCM	1	Output	This pin outputs the common-mode voltage (0.95V) that can be used externally to bias the analog input pins
25	CLKP	1	Input	Differential clock positive input
26	CLKM	1	Input	Differential clock negative input
29	INP_A	1	Input	Differential analog positive input, channel A
30	INM_A	1	Input	Differential analog negative input, channel A
35	CTRL1	1	Input	Digital control input pins. Together, they control the various power-down modes.
36	CTRL2	1	Input	Digital control input pins. Together, they control the various power-down modes.
37	CTRL3	1	Input	Digital control input pins. Together, they control the various power-down modes.
49, PAD	DRGND	2	Input	Output buffer ground
56	CLKOUTM	1	Output	Differential output clock, complement
57	CLKOUTP	1	Output	Differential output clock, true
64	SDOUT	1	Output	This pin functions as a serial interface register readout when the READOUT bit is enabled. When READOUT = 0, this pin is in high-impedance state.
Refer to <a href="#">Figure 2</a> and <a href="#">Figure 3</a>	DA0P, DA0M	2	Output	Channel A differential output data pair, D0 and D1 multiplexed
Refer to <a href="#">Figure 2</a> and <a href="#">Figure 3</a>	DA2P, DA2M	2	Output	Channel A differential output data D2 and D3 multiplexed
Refer to <a href="#">Figure 2</a> and <a href="#">Figure 3</a>	DA4P, DA4M	2	Output	Channel A differential output data D4 and D5 multiplexed
Refer to <a href="#">Figure 2</a> and <a href="#">Figure 3</a>	DA6P, DA6M	2	Output	Channel A differential output data D6 and D7 multiplexed
Refer to <a href="#">Figure 2</a> and <a href="#">Figure 3</a>	DA8P, DA8M	2	Output	Channel A differential output data D8 and D9 multiplexed
Refer to <a href="#">Figure 2</a> and <a href="#">Figure 3</a>	DA10P, DA10M	2	Output	Channel A differential output data D10 and D11 multiplexed
Refer to <a href="#">Figure 2</a> and <a href="#">Figure 3</a>	DA12P, DA12M	2	Output	Channel A differential output data D12 and D13 multiplexed (ADS424x only)
Refer to <a href="#">Figure 2</a> and <a href="#">Figure 3</a>	DB0P, DB0M	2	Output	Channel B differential output data pair, D0 and D1 multiplexed
Refer to <a href="#">Figure 2</a> and <a href="#">Figure 3</a>	DB2P, DB2M	2	Output	Channel B differential output data D2 and D3 multiplexed

**Pin Descriptions: LVDS Mode (continued)**

PIN NUMBER	PIN NAME	# OF PINS	FUNCTION	DESCRIPTION
Refer to <a href="#">Figure 2</a> and <a href="#">Figure 3</a>	DB4P, DB4M	2	Output	Channel B differential output data D4 and D5 multiplexed
Refer to <a href="#">Figure 2</a> and <a href="#">Figure 3</a>	DB6P, DB6M	2	Output	Channel B differential output data D6 and D7 multiplexed
Refer to <a href="#">Figure 2</a> and <a href="#">Figure 3</a>	DB8P, DB8M	2	Output	Channel B differential output data D8 and D9 multiplexed
Refer to <a href="#">Figure 2</a> and <a href="#">Figure 3</a>	DB10P, DB10M	2	Output	Channel B differential output data D10 and D11 multiplexed
Refer to <a href="#">Figure 2</a> and <a href="#">Figure 3</a>	DB12P, DB12M	2	Output	Channel B differential output data D12 and D13 multiplexed (ADS424x only)
Refer to <a href="#">Figure 38</a> , <a href="#">Figure 39</a> , <a href="#">Figure 56</a> , and <a href="#">Figure 57</a>	NC	8 (ADS422x) 4 (ADS424x)	—	Do not connect, must be floated





**Pin Descriptions: CMOS Mode**

PIN NUMBER	PIN NAME	# OF PINS	FUNCTION	DESCRIPTION
1, 48	DRVDD	2	Input	Output buffer supply
12	RESET	1	Input	Serial interface RESET input. When using the serial interface mode, the internal registers must be initialized through a hardware RESET by applying a high pulse on this pin or by using the software reset option; refer to the <a href="#">Serial Interface Configuration</a> section. In parallel interface mode, the RESET pin must be permanently tied high. SDATA and SEN are used as parallel control pins in this mode. This pin has an internal 150kΩ pull-down resistor.
13	SCLK	1	Input	This pin functions as a serial interface clock input when RESET is low. It controls the low-speed mode when RESET is tied high; see <a href="#">Table 5</a> for detailed information. This pin has an internal 150kΩ pull-down resistor.
14	SDATA	1	Input	Serial interface data input; this pin has an internal 150kΩ pull-down resistor.
15	SEN	1	Input	This pin functions as a serial interface enable input when RESET is low. It controls the output interface and data format selection when RESET is tied high; see <a href="#">Table 6</a> for detailed information. This pin has an internal 150kΩ pull-up resistor to AVDD.
16, 22, 33, 34	AVDD	4	Input	Analog power supply
17, 18, 21, 24, 27, 28, 31, 32	AGND	8	Input	Analog ground
19	INP_B	1	Input	Differential analog positive input, channel B
20	INM_B	1	Input	Differential analog negative input, channel B
23	VCM	1	Output	This pin outputs the common-mode voltage (0.95V) that can be used externally to bias the analog input pins
25	CLKP	1	Input	Differential clock positive input
26	CLKM	1	Input	Differential clock negative input
29	INP_A	1	Input	Differential analog positive input, channel A
30	INM_A	1	Input	Differential analog negative input, channel A
35	CTRL1	1	Input	Digital control input pins. Together, they control various power-down modes.
36	CTRL2	1	Input	Digital control input pins. Together, they control various power-down modes.
37	CTRL3	1	Input	Digital control input pins. Together, they control various power-down modes.
49, PAD	DRGND	2	Input	Output buffer ground
56	UNUSED	1	—	This pin is not used in the CMOS interface
57	CLKOUT	1	Output	CMOS output clock
64	SDOUT	1	Output	This pin functions as a serial interface register readout when the READOUT bit is enabled. When READOUT = 0, this pin is in high-impedance state.
Refer to <a href="#">Figure 4</a> and <a href="#">Figure 5</a>	DA0 to DA11	12	Output	Channel A ADC output data bits, CMOS levels
Refer to <a href="#">Figure 4</a>	DA12 to DA13	2	Output	Channel A ADC output data bits, CMOS levels (ADS424x only)
Refer to <a href="#">Figure 4</a> and <a href="#">Figure 5</a>	DB0 to DB11	12	Output	Channel B ADC output data bits, CMOS levels
Refer to <a href="#">Figure 4</a>	DB12 to DB13	2	Output	Channel B ADC output data bits, CMOS levels (ADS424x only)
—	NC	1	—	Do not connect, must be floated

FUNCTIONAL BLOCK DIAGRAM

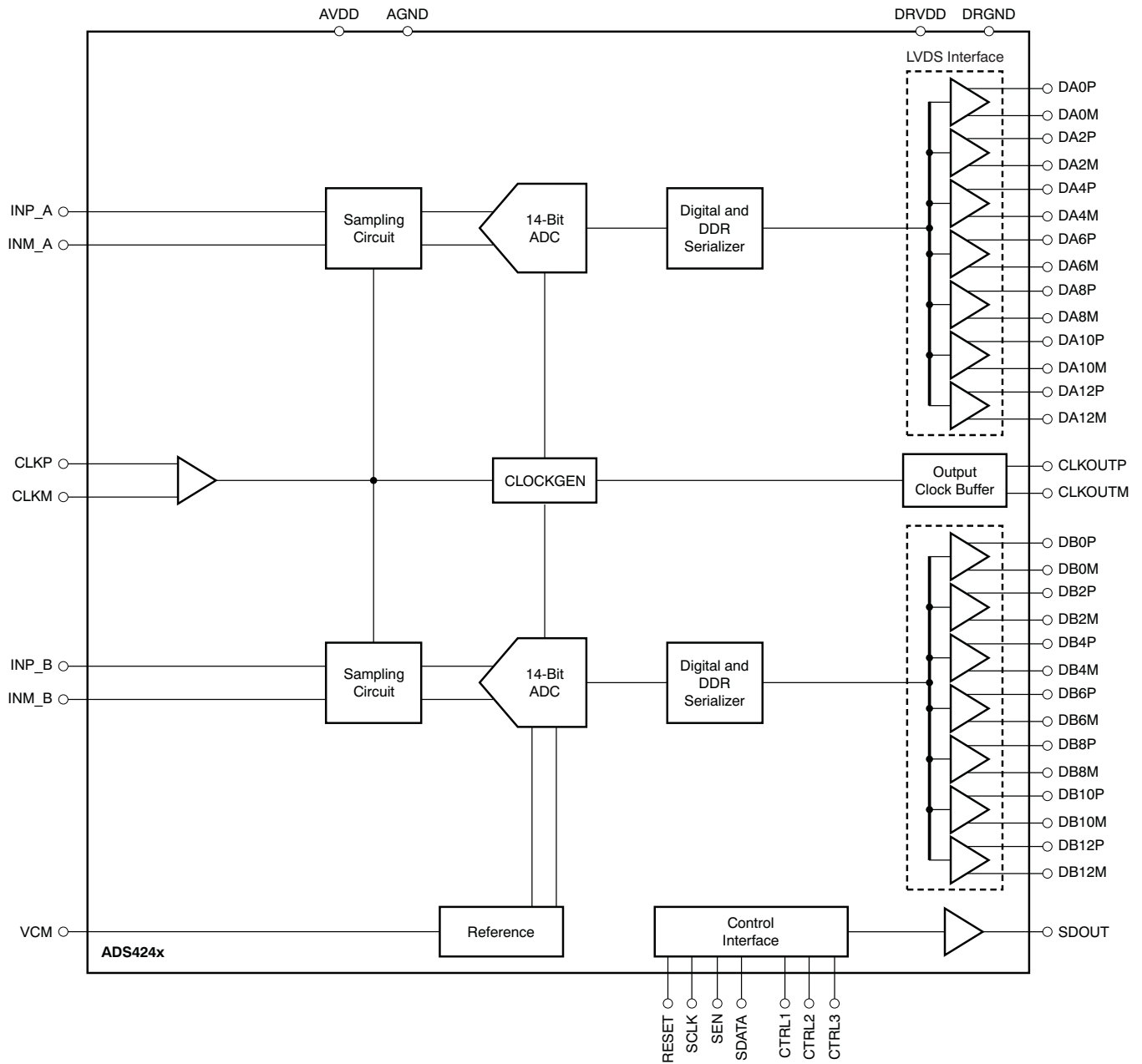

Figure 6. ADS4246/45/42 Block Diagram

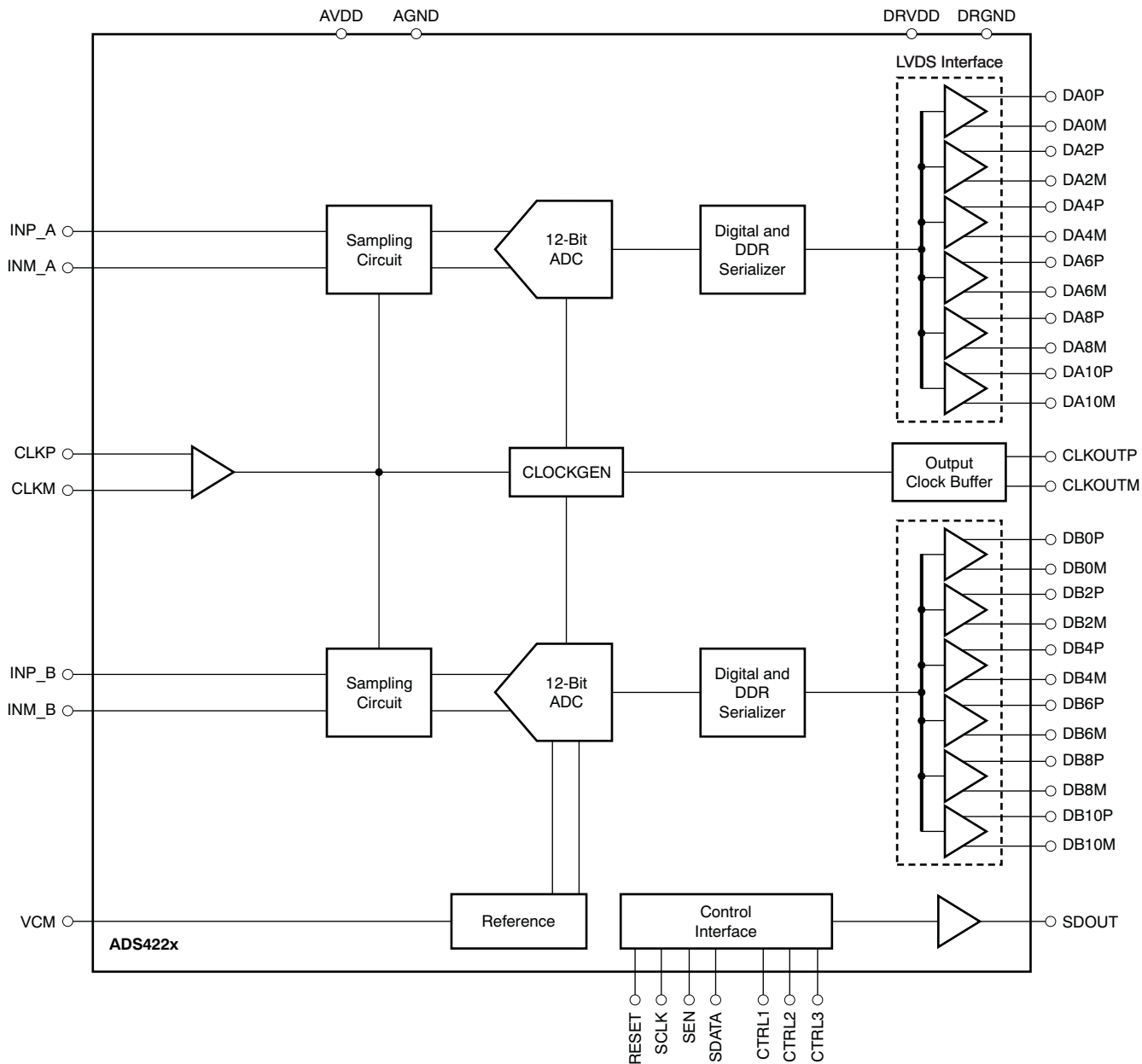

Figure 7. ADS4226/25/22 Block Diagram

## TIMING CHARACTERISTICS: LVDS AND CMOS MODES<sup>(1)</sup>

Typical values are at +25°C, AVDD = 1.8 V, DRVDD = 1.8V, sampling frequency = 160MSPS, sine wave input clock, 1.5V<sub>pp</sub> clock amplitude, C<sub>LOAD</sub> = 5pF<sup>(2)</sup>, and R<sub>LOAD</sub> = 100Ω<sup>(3)</sup>, unless otherwise noted. Minimum and maximum values are across the full temperature range: T<sub>MIN</sub> = -40°C to T<sub>MAX</sub> = +85°C, AVDD = 1.8V, and DRVDD = 1.7V to 1.9V.

PARAMETER	DESCRIPTION	MIN	TYP	MAX	UNIT		
t <sub>A</sub>	Aperture delay	0.5	0.8	1.1	ns		
	Aperture delay matching	Between the two channels of the same device		±70	ps		
	Variation of aperture delay	Between two devices at the same temperature and DRVDD supply		±150	ps		
t <sub>J</sub>	Aperture jitter			140	f <sub>S</sub> rms		
	Wakeup time	Time to valid data after coming out of STANDBY mode		50	100	μs	
		Time to valid data after coming out of GLOBAL power-down mode		100	500	μs	
ADC latency <sup>(4)</sup>	Default latency after reset		16		Clock cycles		
	Digital functions enabled (EN DIGITAL = 1)		24		Clock cycles		
<b>DDR LVDS MODE<sup>(5)</sup></b>							
t <sub>SU</sub>	Data setup time	Data valid <sup>(6)</sup> to zero-crossing of CLKOUTP		1.5	2.0	ns	
t <sub>H</sub>	Data hold time	Zero-crossing of CLKOUTP to data becoming invalid <sup>(6)</sup>		0.35	0.6	ns	
t <sub>PDI</sub>	Clock propagation delay	Input clock rising edge cross-over to output clock rising edge cross-over		5.0	6.1	7.5	ns
	LVDS bit clock duty cycle	Duty cycle of differential clock, (CLKOUTP-CLKOUTM)		49		%	
t <sub>RISE</sub> , t <sub>FALL</sub>	Data rise time, Data fall time	Rise time measured from -100mV to +100mV Fall time measured from +100mV to -100mV 1MSPS ≤ Sampling frequency ≤ 160MSPS		0.13		ns	
t <sub>CLKRISE</sub> , t <sub>CLKFALL</sub>	Output clock rise time, Output clock fall time	Rise time measured from -100mV to +100mV Fall time measured from +100mV to -100mV 1MSPS ≤ Sampling frequency ≤ 160MSPS		0.13		ns	
<b>PARALLEL CMOS MODE</b>							
t <sub>SU</sub>	Data setup time	Data valid <sup>(7)</sup> to zero-crossing of CLKOUT		1.6	2.5	ns	
t <sub>H</sub>	Data hold time	Zero-crossing of CLKOUT to data becoming invalid <sup>(7)</sup>		2.3	2.7	ns	
t <sub>PDI</sub>	Clock propagation delay	Input clock rising edge cross-over to output clock rising edge cross-over		4.5	6.4	8.5	ns
	Output clock duty cycle	Duty cycle of output clock, CLKOUT 1MSPS ≤ Sampling frequency ≤ 160MSPS		46		%	
t <sub>RISE</sub> , t <sub>FALL</sub>	Data rise time, Data fall time	Rise time measured from 20% to 80% of DRVDD Fall time measured from 80% to 20% of DRVDD 1MSPS ≤ Sampling frequency ≤ 160MSPS		1		ns	
t <sub>CLKRISE</sub> , t <sub>CLKFALL</sub>	Output clock rise time Output clock fall time	Rise time measured from 20% to 80% of DRVDD Fall time measured from 80% to 20% of DRVDD 1MSPS ≤ Sampling frequency ≤ 160MSPS		1		ns	

- (1) Timing parameters are ensured by design and characterization and not tested in production.
- (2) C<sub>LOAD</sub> is the effective external single-ended load capacitance between each output pin and ground
- (3) R<sub>LOAD</sub> is the differential load resistance between the LVDS output pair.
- (4) At higher frequencies, t<sub>PDI</sub> is greater than one clock period and overall latency = ADC latency + 1.
- (5) Measurements are done with a transmission line of 100Ω characteristic impedance between the device and the load. Setup and hold time specifications take into account the effect of jitter on the output data and clock.
- (6) Data valid refers to a logic high of +100mV and a logic low of -100mV.
- (7) Data valid refers to a logic high of 1.26V and a logic low of 0.54V

**Table 2. LVDS Timings at Lower Sampling Frequencies**

SAMPLING FREQUENCY (MSPS)	SETUP TIME (ns)			HOLD TIME (ns)			$t_{PDI}$ , CLOCK PROPAGATION DELAY (ns)		
	MIN	TYP	MAX	MIN	TYP	MAX	MIN	TYP	MAX
65	5.9	6.6		0.35	0.6		5.0	6.1	7.5
80	4.5	5.2		0.35	0.6		5.0	6.1	7.5
105	3.1	3.6		0.35	0.6		5.0	6.1	7.5
125	2.3	2.9		0.35	0.6		5.0	6.1	7.5
150	1.7	2.2		0.35	0.6		5.0	6.1	7.5

**Table 3. CMOS Timings at Lower Sampling Frequencies**

SAMPLING FREQUENCY (MSPS)	TIMINGS SPECIFIED WITH RESPECT TO CLKOUT								
	SETUP TIME (ns)			HOLD TIME (ns)			$t_{PDI}$ , CLOCK PROPAGATION DELAY (ns)		
	MIN	TYP	MAX	MIN	TYP	MAX	MIN	TYP	MAX
65	6.1	7.2		6.7	7.1		4.5	6.4	8.5
80	4.7	5.8		5.3	5.8		4.5	6.4	8.5
105	3.4	4.3		3.8	4.3		4.5	6.4	8.5
125	2.7	3.6		3.1	3.6		4.5	6.4	8.5
150	1.9	2.8		2.5	2.9		4.5	6.4	8.5

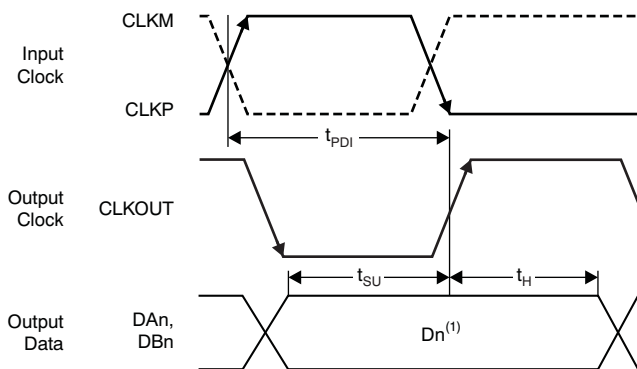

(1) Dn = bits D0, D1, D2, etc. of channels A and B.

**Figure 8. CMOS Interface Timing Diagram**

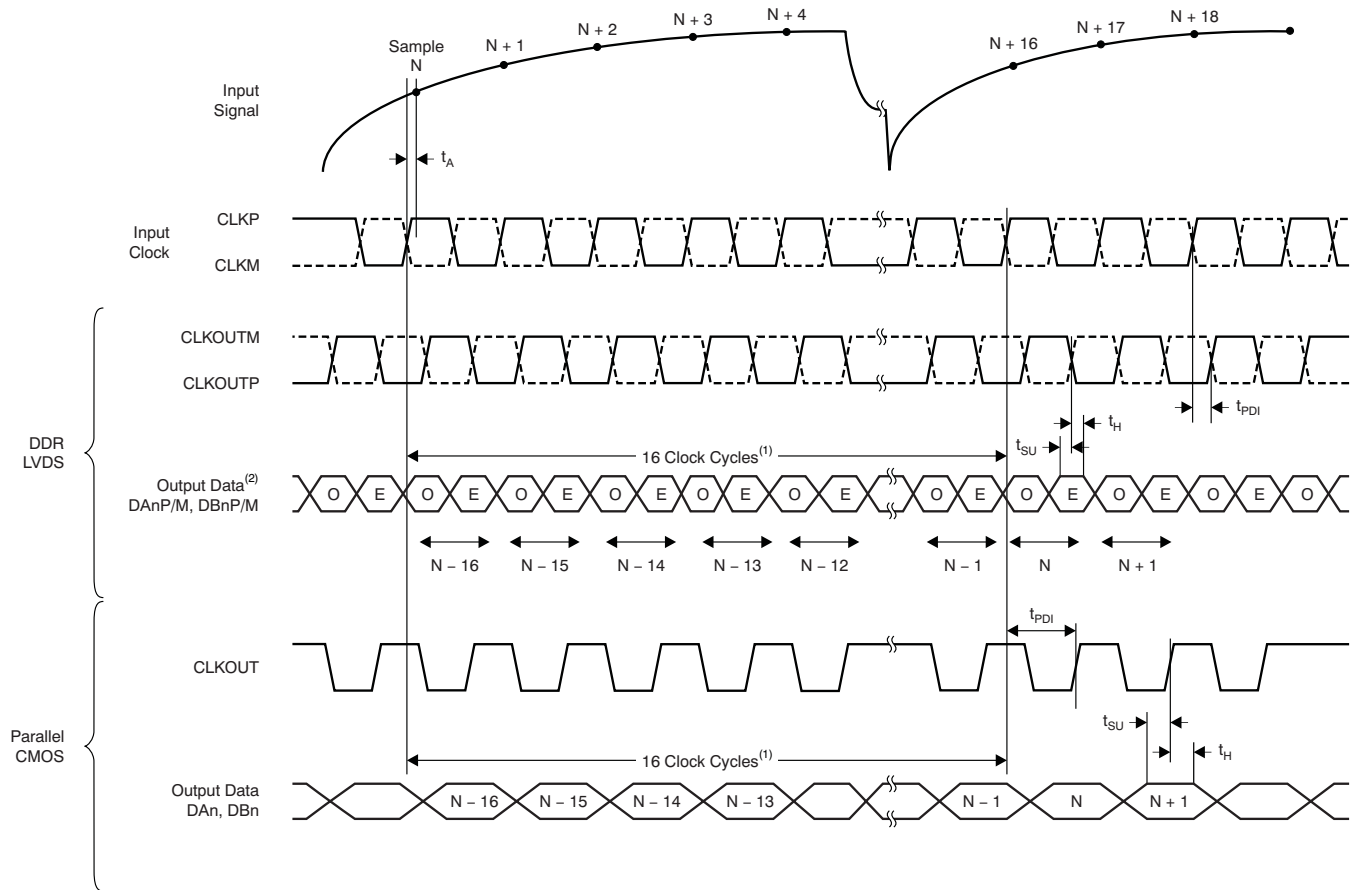

(1) ADC latency after reset. At higher sampling frequencies,  $t_{PDI}$  is greater than one clock cycle, which then makes the overall latency = ADC latency + 1.

(2) E = even bits (D0, D2, D4, etc.); O = odd bits (D1, D3, D5, etc.).

**Figure 9. Latency Timing Diagram**

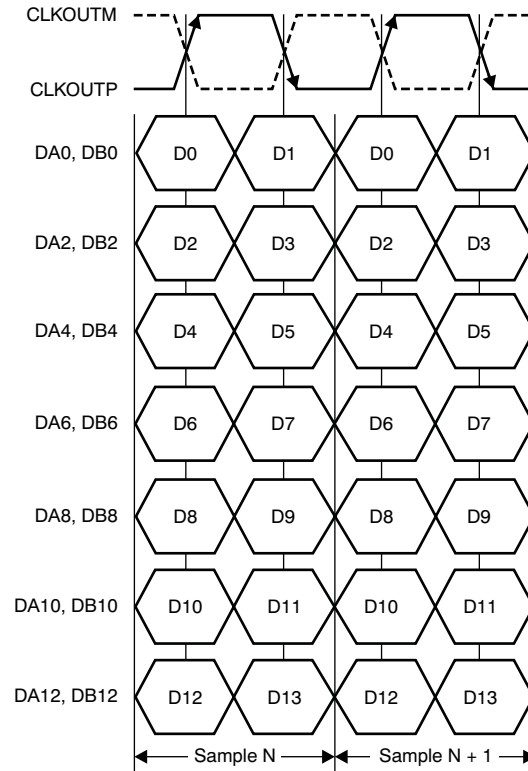

Figure 10. ADS4246/45/42 LVDS Interface Timing Diagram

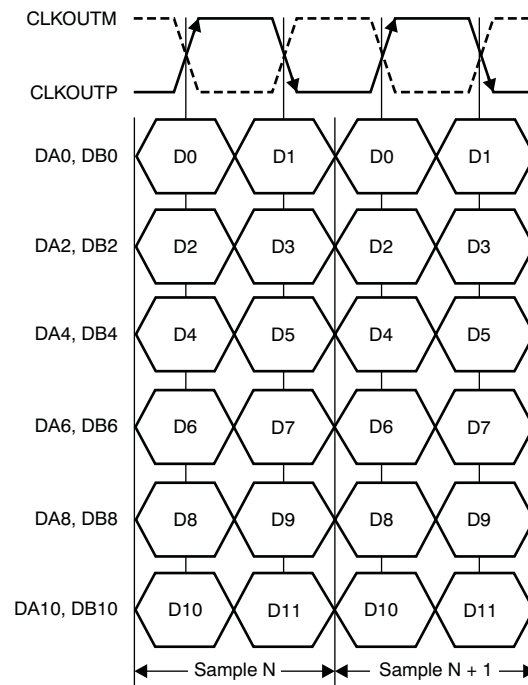

Figure 11. ADS4226/25/22 LVDS Interface Timing Diagram

## DEVICE CONFIGURATION

The ADS424x/422x can be configured independently using either parallel interface control or serial interface programming.

### PARALLEL CONFIGURATION ONLY

To put the device into parallel configuration mode, keep RESET tied high (AVDD). Then, use the SEN, SCLK, CTRL1, CTRL2, and CTRL3 pins to directly control certain modes of the ADC. The device can be easily configured by connecting the parallel pins to the correct voltage levels (as described in [Table 4](#) to [Table 7](#)). There is no need to apply a reset and SDATA can be connected to ground.

In this mode, SEN and SCLK function as parallel interface control pins. Some frequently-used functions can be controlled using these pins. [Table 4](#) describes the modes controlled by the parallel pins.

**Table 4. Parallel Pin Definition**

PIN	CONTROL MODE
SCLK	Low-speed mode selection
SEN	Output data format and output interface selection
CTRL1	Together, these pins control the power-down modes
CTRL2	
CTRL3	

### SERIAL INTERFACE CONFIGURATION ONLY

To enable this mode, the serial registers must first be reset to the default values and the RESET pin must be kept low. SEN, SDATA, and SCLK function as serial interface pins in this mode and can be used to access the internal registers of the ADC. The registers can be reset either by applying a pulse on the RESET pin or by setting the RESET bit high. The [Serial Register Map](#) section describes the register programming and the register reset process in more detail.

### USING BOTH SERIAL INTERFACE AND PARALLEL CONTROLS

For increased flexibility, a combination of serial interface registers and parallel pin controls (CTRL1 to CTRL3) can also be used to configure the device. To enable this option, keep RESET low. The parallel interface control pins CTRL1 to CTRL3 are available. After power-up, the device is automatically configured according to the voltage settings on these pins (see [Table 7](#)). SEN, SDATA, and SCLK function as serial interface digital pins and are used to access the internal registers of the ADC. The registers must first be reset to the default values either by applying a pulse on the RESET pin or by setting the RESET bit to '1'. After reset, the RESET pin must be kept low. The [Serial Register Map](#) section describes register programming and the register reset process in more detail.

## PARALLEL CONFIGURATION DETAILS

The functions controlled by each parallel pin are described in [Table 5](#), [Table 6](#), and [Table 7](#). A simple way of configuring the parallel pins is shown in [Figure 12](#).

**Table 5. SCLK Control Pin**

VOLTAGE APPLIED ON SCLK	DESCRIPTION
Low	Low-speed mode is disabled
High	Low-speed mode is enabled <sup>(1)</sup>

(1) Low-speed mode is enabled in the ADS4222/42 by default.

**Table 6. SEN Control Pin**

VOLTAGE APPLIED ON SEN	DESCRIPTION
0 (+50mV/0mV)	Twos complement and parallel CMOS output
(3/8) AVDD (±50mV)	Offset binary and parallel CMOS output
(5/8) 2AVDD (±50mV)	Offset binary and DDR LVDS output
AVDD (0mV/–50mV)	Twos complement and DDR LVDS output

**Table 7. CTRL1, CTRL2, and CTRL3 Pins**

CTRL1	CTRL2	CTRL3	DESCRIPTION
Low	Low	Low	Normal operation
Low	Low	High	Not available
Low	High	Low	Not available
Low	High	High	Not available
High	Low	Low	Global power-down
High	Low	High	Channel A standby, channel B is active
High	High	Low	Not available
High	High	High	MUX mode of operation, channel A and B data are multiplexed and output on the DB[13:0] pins.

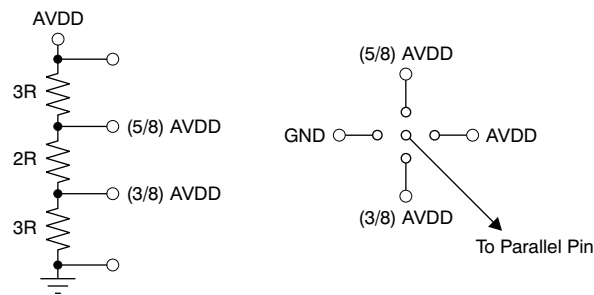

**Figure 12. Simple Scheme to Configure the Parallel Pins**

## SERIAL INTERFACE DETAILS

The ADC has a set of internal registers that can be accessed by the serial interface formed by the SEN (serial interface enable), SCLK (serial interface clock), and SDATA (serial interface data) pins. Serial shift of bits into the device is enabled when SEN is low. Serial data SDATA are latched at every SCLK falling edge when SEN is active (low). The serial data are loaded into the register at every 16th SCLK falling edge when SEN is low. When the word length exceeds a multiple of 16 bits, the excess bits are ignored. Data can be loaded in multiples of 16-bit words within a single active SEN pulse. The first eight bits form the register address and the remaining eight bits are the register data. The interface can work with SCLK frequencies from 20MHz down to very low speeds (of a few hertz) and also with non-50% SCLK duty cycle.

### Register Initialization

After power-up, the internal registers must be initialized to the default values. Initialization can be accomplished in one of two ways:

1. Either through hardware reset by applying a high pulse on the RESET pin (of width greater than 10ns), as shown in Figure 13; or
2. By applying a software reset. When using the serial interface, set the RESET bit high. This setting initializes the internal registers to the default values and then self-resets the RESET bit low. In this case, the RESET pin is kept low.

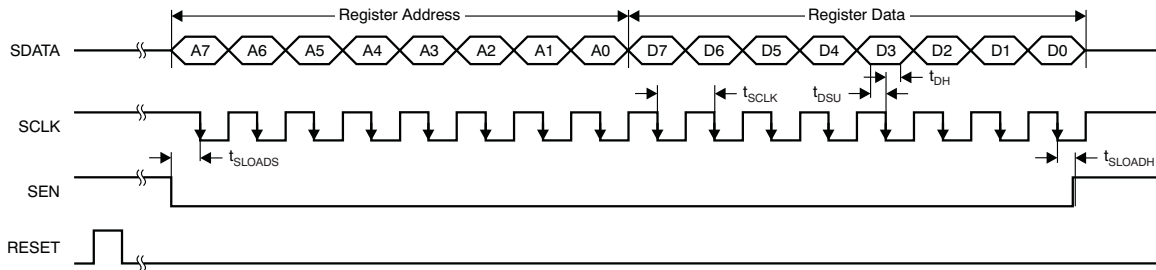

Figure 13. Serial Interface Timing

Table 8. Serial Interface Timing Characteristics<sup>(1)</sup>

PARAMETER		MIN	TYP	MAX	UNIT
$f_{SCLK}$	SCLK frequency (equal to $1/t_{SCLK}$ )	> DC		20	MHz
$t_{LOADS}$	SEN to SCLK setup time	25			ns
$t_{LOADH}$	SCLK to SEN hold time	25			ns
$t_{DSU}$	SDATA setup time	25			ns
$t_{DH}$	SDATA hold time	25			ns

(1) Typical values at +25°C; minimum and maximum values across the full temperature range:  $T_{MIN} = -40^{\circ}\text{C}$  to  $T_{MAX} = +85^{\circ}\text{C}$ ,  $AVDD = 1.8\text{V}$ , and  $DRVDD = 1.8\text{V}$ , unless otherwise noted.

### Serial Register Readout

The device includes a mode where the contents of the internal registers can be read back. This readback mode may be useful as a diagnostic check to verify the serial interface communication between the external controller and the ADC. To use readback mode, follow this procedure:

1. Set the READOUT register bit to '1'. This setting disables any further writes to the registers.
2. Initiate a serial interface cycle specifying the address of the register (A7 to A0) whose content has to be read.
3. The device outputs the contents (D7 to D0) of the selected register on the SDOUT pin (pin 64).
4. The external controller can latch the contents at the SCLK falling edge.
5. To enable register writes, reset the READOUT register bit to '0'.

The serial register readout works with both CMOS and LVDS interfaces on pin 64.

When READOUT is disabled, the SDOUT pin is in high-impedance state. If serial readout is not used, the SDOUT pin must float.

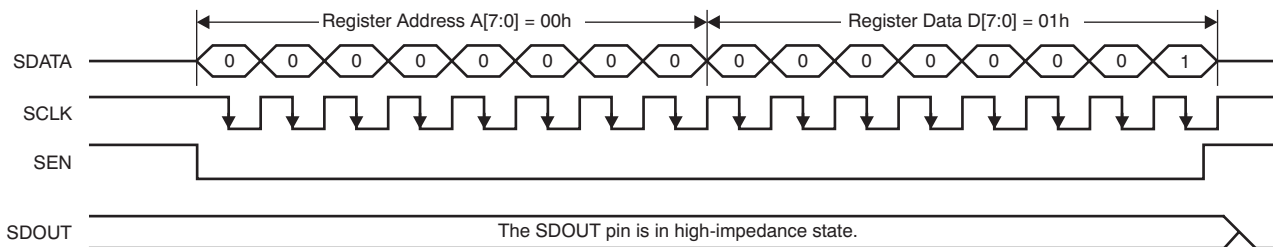

a) Enable serial readout (READOUT = 1)

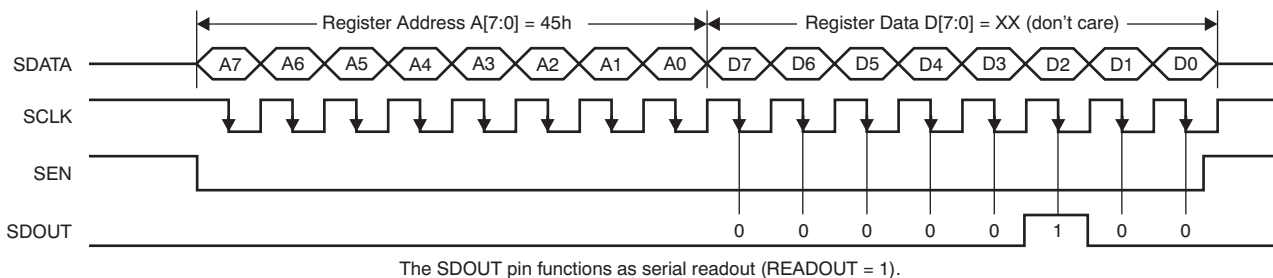

b) Read contents of Register 45h. This register has been initialized with 04h (device is put into global power-down mode.)

Figure 14. Serial Readout Timing Diagram

Table 9. Reset Timing (Only when Serial Interface is Used)<sup>(1)</sup>

PARAMETER		CONDITIONS	MIN	TYP	MAX	UNIT
t <sub>1</sub>	Power-on delay	Delay from AVDD and DRVDD power-up to active RESET pulse	1			ms
t <sub>2</sub>	Reset pulse width	Active RESET signal pulse width	10			ns
					1	µs
t <sub>3</sub>	Register write delay	Delay from RESET disable to SEN active	100			ns

(1) Typical values at +25°C; minimum and maximum values across the full temperature range: T<sub>MIN</sub> = -40°C to T<sub>MAX</sub> = +85°C, unless otherwise noted.



NOTE: A high pulse on the RESET pin is required in the serial interface mode when initialized through a hardware reset. For parallel interface operation, RESET must be permanently tied high.

Figure 15. Reset Timing Diagram

## SERIAL REGISTER MAP

Table 10 summarizes the functions supported by the serial interface.

**Table 10. Serial Interface Register Map<sup>(1)</sup>**

REGISTER ADDRESS	REGISTER DATA								
A[7:0] (Hex)	D7	D6	D5	D4	D3	D2	D1	D0	
00	0	0	0	0	0	0	RESET	READOUT	
01	LVDS SWING						0	0	
03	0	0	0	0	0	0	HIGH PERF MODE		
25	CH A GAIN				0	CH A TEST PATTERNS			
29	0	0	0	DATA FORMAT		0	0	0	
2B	CH B GAIN				0	CH B TEST PATTERNS			
3D	0	0	ENABLE OFFSET CORR	0	0	0	0	0	
3F	0	0	CUSTOM PATTERN D[13:8]						
40	CUSTOM PATTERN D[7:0]								
41	LVDS CMOS		CMOS CLKOUT STRENGTH		0	0	DIS OBUF		
42	CLKOUT FALL POSN		CLKOUT RISE POSN		EN DIGITAL	0	0	0	
45	STBY	LVDS CLKOUT STRENGTH	LVDS DATA STRENGTH	0	0	PDN GLOBAL	0	0	
4A	0	0	0	0	0	0	0	HIGH FREQ MODE CH B <sup>(2)</sup>	
58	0	0	0	0	0	0	0	HIGH FREQ MODE CH A <sup>(2)</sup>	
BF	CH A OFFSET PEDESTAL						0	0	
C1	CH B OFFSET PEDESTAL						0	0	
CF	FREEZE OFFSET CORR	0	OFFSET CORR TIME CONSTANT					0	0
DB	0	0	0	0	0	0	0	LOW SPEED MODE CH B <sup>(3)</sup>	
EF	0	0	0	EN LOW SPEED MODE <sup>(3)</sup>	0	0	0	0	
F1	0	0	0	0	0	0	EN LVDS SWING		
F2	0	0	0	0	LOW SPEED MODE CH A <sup>(3)</sup>	0	0	0	

(1) Multiple functions in a register can be programmed in a single write operation. All registers default to '0' after reset.

(2) These bits improve SFDR on high frequencies. The frequency limit is 200MHz.

(3) Low-speed mode is not applicable for the ADS4242 and ADS4222.

**DESCRIPTION OF SERIAL REGISTERS**
**Register Address 00h (Default = 00h)**

7	6	5	4	3	2	1	0
0	0	0	0	0	0	RESET	READOUT

**Bits[7:2]** Always write '0'

**Bit 1** **RESET: Software reset applied**

This bit resets all internal registers to the default values and self-clears to 0 (default = 1).

**Bit 0** **READOUT: Serial readout**

This bit sets the serial readout of the registers.

0 = Serial readout of registers disabled; the SDOUT pin is placed in high-impedance state.

1 = Serial readout enabled; the SDOUT pin functions as a serial data readout with CMOS logic levels running from the DRVDD supply. See the [Serial Register Readout](#) section.

**Register Address 01h (Default = 00h)**

7	6	5	4	3	2	1	0
LVDS SWING						0	0

**Bits[7:2]** **LVDS SWING: LVDS swing programmability**

These bits program the LVDS swing. Set the EN LVDS SWING bit to '1' before programming swing.

000000 = Default LVDS swing;  $\pm 350\text{mV}$  with external  $100\Omega$  termination

011011 = LVDS swing increases to  $\pm 410\text{mV}$

110010 = LVDS swing increases to  $\pm 465\text{mV}$

010100 = LVDS swing increases to  $\pm 570\text{mV}$

111110 = LVDS swing decreases to  $\pm 200\text{mV}$

001111 = LVDS swing decreases to  $\pm 125\text{mV}$

**Bits[1:0]** Always write '0'

**Register Address 03h (Default = 00h)**

7	6	5	4	3	2	1	0
0	0	0	0	0	0	HIGH PERF MODE	

**Bits[7:2]** Always write '0'

**Bits[1:0]** **HIGH PERF MODE: High-performance mode**

00 = Default performance

01 = Do not use

10 = Do not use

11 = Obtain best performance across sample clock and input signal frequencies

**Register Address 25h (Default = 00h)**

7	6	5	4	3	2	1	0
CH A GAIN				0	CH A TEST PATTERNS		

**Bits[7:4] CH A GAIN: Channel A gain programmability**

These bits set the gain programmability in 0.5dB steps for channel A.

- 0000 = 0dB gain (default after reset)
- 0001 = 0.5dB gain
- 0010 = 1dB gain
- 0011 = 1.5dB gain
- 0100 = 2dB gain
- 0101 = 2.5dB gain
- 0110 = 3dB gain
- 0111 = 3.5dB gain
- 1000 = 4dB gain
- 1001 = 4.5dB gain
- 1010 = 5dB gain
- 1011 = 5.5dB gain
- 1100 = 6dB gain

**Bit 3 Always write '0'**

**Bits[2:0] CH A TEST PATTERNS: Channel A data capture**

These bits verify data capture for channel A.

- 000 = Normal operation
- 001 = Outputs all 0s
- 010 = Outputs all 1s
- 011 = Outputs toggle pattern.
- For the ADS424x, output data D[13:0] are an alternating sequence of *101010101010* and *010101010101*.
- For the ADS422x, the output data D[11:0] are an alternating sequence of *101010101010* and *010101010101*.
- 100 = Outputs digital ramp.
- For the ADS424x, output data increment by one LSB (14-bit) every clock cycle from code 0 to code 16383.
- For the ADS422x, output data increment by one LSB (12-bit) every fourth clock cycle from code 0 to code 4095.
- 101 = Outputs custom pattern; use registers 3Fh and 40h to set the custom pattern
- 110 = Unused
- 111 = Unused

**Register Address 29h (Default = 00h)**

7	6	5	4	3	2	1	0
0	0	0	DATA FORMAT		0	0	0

**Bits[7:5] Always write '0'**

**Bits[4:3] DATA FORMAT: Data format selection**

- 00 = Twos complement
- 01 = Twos complement
- 10 = Twos complement
- 11 = Offset binary

**Bits[2:0] Always write '0'**

**Register Address 2Bh (Default = 00h)**

7	6	5	4	3	2	1	0
CH B GAIN				0	CH B TEST PATTERNS		

**Bits[7:4] CH B GAIN: Channel B gain programmability**

These bits set the gain programmability in 0.5dB steps for channel B.

- 0000 = 0dB gain (default after reset)
- 0001 = 0.5dB gain
- 0010 = 1dB gain
- 0011 = 1.5dB gain
- 0100 = 2dB gain
- 0101 = 2.5dB gain
- 0110 = 3dB gain
- 0111 = 3.5dB gain
- 1000 = 4dB gain
- 1001 = 4.5dB gain
- 1010 = 5dB gain
- 1011 = 5.5dB gain
- 1100 = 6dB gain

**Bit 3 Always write '0'**
**Bits[2:0] CH B TEST PATTERNS: Channel B data capture**

These bits verify data capture for channel B.

- 000 = Normal operation
- 001 = Outputs all 0s
- 010 = Outputs all 1s
- 011 = Outputs toggle pattern.

For the ADS424x, output data D[13:0] are an alternating sequence of *101010101010* and *010101010101*.

For the ADS422x, the output data D[11:0] are an alternating sequence of *1010101010* and *0101010101*.

100 = Outputs digital ramp.

For the ADS424x, output data increment by one LSB (14-bit) every clock cycle from code 0 to code 16383.

For the ADS422x, output data increment by one LSB (12-bit) every fourth clock cycle from code 0 to code 4095.

- 101 = Outputs custom pattern; use registers 3Fh and 40h to set the custom pattern
- 110 = Unused
- 111 = Unused

**Register Address 3Dh (Default = 00h)**

7	6	5	4	3	2	1	0
0	0	ENABLE OFFSET CORR	0	0	0	0	0

**Bits[7:6]** Always write '0'

**Bit 5** **ENABLE OFFSET CORR: Offset correction setting**

This bit enables the offset correction.

0 = Offset correction disabled

1 = Offset correction enabled

**Bits[4:0]** Always write '0'

**Register Address 3Fh (Default = 00h)**

7	6	5	4	3	2	1	0
0	0	CUSTOM PATTERN D13	CUSTOM PATTERN D12	CUSTOM PATTERN D11	CUSTOM PATTERN D10	CUSTOM PATTERN D9	CUSTOM PATTERN D8

**Bits[7:6]** Always write '0'

**Bits[5:0]** **CUSTOM PATTERN D[13:8]**

These are the six upper bits of the custom pattern available at the output instead of ADC data.

Note that for the ADS424x, the custom pattern is 14-bit. The ADS422x custom pattern is 12-bit.

**Register Address 40h (Default = 00h)**

7	6	5	4	3	2	1	0
CUSTOM PATTERN D7	CUSTOM PATTERN D6	CUSTOM PATTERN D5	CUSTOM PATTERN D4	CUSTOM PATTERN D3	CUSTOM PATTERN D2	CUSTOM PATTERN D1	CUSTOM PATTERN D0

**Bits[7:0]** **CUSTOM PATTERN D[7:0]**

These are the eight upper bits of the custom pattern available at the output instead of ADC data.

Note that for the ADS424x, the custom pattern is 14-bit. The ADS422x custom pattern is 12-bit; use the CUSTOM PATTERN D[13:2] register bits.

**Register Address 41h (Default = 00h)**

7	6	5	4	3	2	1	0
LVDS CMOS	CMOS CLKOUT STRENGTH		0	0	DIS OBUF		

**Bits[7:6] LVDS CMOS: Interface selection**

These bits select the interface.

00 = DDR LVDS interface

01 = DDR LVDS interface

10 = DDR LVDS interface

11 = Parallel CMOS interface

**Bits[5:4] CMOS CLKOUT STRENGTH**

These bits control the strength of the CMOS output clock.

00 = Maximum strength (recommended)

01 = Medium strength

10 = Low strength

11 = Very low strength

**Bits[3:2] Always write '0'**
**Bits[1:0] DIS OBUF**

These bits power down data and clock output buffers for both the CMOS and LVDS output interface. When powered down, the output buffers are in 3-state.

00 = Default

01 = Power-down data output buffers for channel B

10 = Power-down data output buffers for channel A

11 = Power-down data output buffers for both channels as well as the clock output buffer

**Register Address 42h (Default = 00h)**

7	6	5	4	3	2	1	0
CLKOUT FALL POSN		CLKOUT RISE POSN		EN DIGITAL	0	0	0

**Bits[7:6] CLKOUT FALL POSN**

In LVDS mode:

00 = Default

01 = The falling edge of the output clock advances by 450 ps

10 = The falling edge of the output clock advances by 150 ps

11 = The falling edge of the output clock is delayed by 550 ps

In CMOS mode:

00 = Default

01 = The falling edge of the output clock is delayed by 150 ps

10 = Do not use

11 = The falling edge of the output clock advances by 100 ps

**Bits[5:6] CLKOUT RISE POSN**

In LVDS mode:

00 = Default

01 = The rising edge of the output clock advances by 450 ps

10 = The rising edge of the output clock advances by 150 ps

11 = The rising edge of the output clock is delayed by 250 ps

In CMOS mode:

00 = Default

01 = The rising edge of the output clock is delayed by 150 ps

10 = Do not use

11 = The rising edge of the output clock advances by 100 ps

**Bit 3 EN DIGITAL: Digital function enable**

0 = All digital functions disabled

1 = All digital functions (such as test patterns, gain, and offset correction) enabled

**Bits[2:0] Always write '0'**

**Register Address 45h (Default = 00h)**

7	6	5	4	3	2	1	0
STBY	LVDS CLKOUT STRENGTH	LVDS DATA STRENGTH	0	0	PDN GLOBAL	0	0

**Bit 7 STBY: Standby setting**

0 = Normal operation

1 = Both channels are put in standby; wakeup time from this mode is fast (typically 50µs).

**Bit 6 LVDS CLKOUT STRENGTH: LVDS output clock buffer strength setting**

0 = LVDS output clock buffer at default strength to be used with 100Ω external termination

1 = LVDS output clock buffer has double strength to be used with 50Ω external termination

**Bit 5 LVDS DATA STRENGTH**

0 = All LVDS data buffers at default strength to be used with 100Ω external termination

1 = All LVDS data buffers have double strength to be used with 50Ω external termination

**Bits[4:3] Always write '0'**
**Bit 2 PDN GLOBAL**

0 = Normal operation

1 = Total power down; all ADC channels, internal references, and output buffers are powered down. Wakeup time from this mode is slow (typically 100µs).

**Bits[1:0] Always write '0'**
**Register Address 4Ah (Default = 00h)**

7	6	5	4	3	2	1	0
0	0	0	0	0	0	0	HIGH FREQ MODE CH B

**Bits[7:1] Always write '0'**
**Bit 0 HIGH FREQ MODE CH B: High-frequency mode for channel B**

0 = Default

1 = Use this mode for high input frequencies

**Register Address 58h (Default = 00h)**

7	6	5	4	3	2	1	0
0	0	0	0	0	0	0	HIGH FREQ MODE CH A

**Bits[7:1] Always write '0'**
**Bit 0 HIGH FREQ MODE CH A: High-frequency mode for channel A**

0 = Default

1 = Use this mode for high input frequencies

**Register Address BFh (Default = 00h)**

7	6	5	4	3	2	1	0
CH A OFFSET PEDESTAL						0	0

**Bits[7:2] CH A OFFSET PEDESTAL: Channel A offset pedestal selection**

When the offset correction is enabled, the final converged value after the offset is corrected is the ADC midcode value. A pedestal can be added to the final converged value by programming these bits. See the [Offset Correction](#) section. Channels can be independently programmed for different offset pedestals by choosing the relevant register address.

For the ADS424x, the pedestal ranges from –32 to +31, so the output code can vary from midcode-32 to midcode+32 by adding pedestal D7-D2.

For the ADS422x, the pedestal ranges from –8 to +7, so the output code can vary from midcode-8 to midcode+7 by adding pedestal D7-D4.

**ADS422x (Program Bits D[7:4])**

- 0111 = Midcode+7
- 0110 = Midcode+6
- 0101 = Midcode+5
- ...
- 0000 = Midcode
- 1111 = Midcode-1
- 1110 = Midcode-2
- 1101 = Midcode-3
- ...
- 1000 = Midcode-8

**ADS424x (Program Bits D[7:2])**

- 011111 = Midcode+31
- 011110 = Midcode+30
- 011101 = Midcode+29
- ...
- 000000 = Midcode
- 111111 = Midcode-1
- 111110 = Midcode-2
- 111101 = Midcode-3
- ...
- 100000 = Midcode-32

**Bits[1:0] Always write '0'**

**Register Address C1h (Default = 00h)**

7	6	5	4	3	2	1	0
CH B OFFSET PEDESTAL						0	0

**Bits[7:2] CH B OFFSET PEDESTAL: Channel B offset pedestal selection**

When offset correction is enabled, the final converged value after the offset is corrected is the ADC midcode value. A pedestal can be added to the final converged value by programming these bits; see the [Offset Correction](#) section. Channels can be independently programmed for different offset pedestals by choosing the relevant register address.

For the ADS424x, the pedestal ranges from –32 to +31, so the output code can vary from midcode-32 to midcode+32 by adding pedestal D[7:2]. For the ADS422x, the pedestal ranges from –8 to +7, so the output code can vary from midcode-8 to midcode+7 by adding pedestal D[7:4].

**ADS422x (Program Bits D[7:4])**

0111 = Midcode+7  
 0110 = Midcode+6  
 0101 = Midcode+5  
 ...  
 0000 = Midcode  
 1111 = Midcode-1  
 1110 = Midcode-2  
 1101 = Midcode-3  
 ...  
 1000 = Midcode-8

**ADS424x (Program Bits D[7:2])**

011111 = Midcode+31  
 011110 = Midcode+30  
 011101 = Midcode+29  
 ...  
 000000 = Midcode  
 111111 = Midcode-1  
 111110 = Midcode-2  
 111101 = Midcode-3  
 ...  
 100000 = Midcode-32

**Bits[1:0] Always write '0'**

**Register Address CFh (Default = 00h)**

7	6	5	4	3	2	1	0
FREEZE OFFSET CORR	0	OFFSET CORR TIME CONSTANT				0	0

**Bit 7 FREEZE OFFSET CORR: Freeze offset correction setting**

This bit sets the freeze offset correction estimation.

0 = Estimation of offset correction is not frozen (the EN OFFSET CORR bit must be set)

1 = Estimation of offset correction is frozen (the EN OFFSET CORR bit must be set); when frozen, the last estimated value is used for offset correction of every clock cycle. See the [Offset Correction](#) section.

**Bit 6 Always write '0'**

**Bits[5:2] OFFSET CORR TIME CONSTANT**

The offset correction loop time constant in number of clock cycles. Refer to the [Offset Correction](#) section.

**Bits[1:0] Always write '0'**

**Register Address DBh (Default = 00h)**

7	6	5	4	3	2	1	0
0	0	0	0	0	0	0	LOW SPEED MODE CH B

**Bits[7:1] Always write '0'**

**Bit 0 LOW SPEED MODE CH B: Channel B low-speed mode enable**

This bit enables the low-speed mode for channel B. Set the EN LOW SPEED MODE bit to '1' before using this bit.

0 = Low-speed mode is disabled for channel B

1 = Low-speed mode is enabled for channel B

**Register Address EFh (Default = 00h)**

7	6	5	4	3	2	1	0
0	0	0	EN LOW SPEED MODE	0	0	0	0

**Bits[7:5] Always write '0'**

**Bit 4 EN LOW SPEED MODE: Enable control of low-speed mode through serial register bits (ADS42x5 and ADS42x6 only)**

This bit enables the control of the low-speed mode using the LOW SPEED MODE CH B and LOW SPEED MODE CH A register bits.

0 = Low-speed mode is disabled

1 = Low-speed mode is controlled by serial register bits

**Bits[3:0] Always write '0'**

**Register Address F1h (Default = 00h)**

7	6	5	4	3	2	1	0
0	0	0	0	0	0	EN LVDS SWING	

**Bits[7:2] Always write '0'**

**Bits[1:0] EN LVDS SWING: LVDS swing enable**

These bits enable LVDS swing control using the LVDS SWING register bits.

00 = LVDS swing control using the LVDS SWING register bits is disabled

01 = Do not use

10 = Do not use

11 = LVDS swing control using the LVDS SWING register bits is enabled

**Register Address F2h (Default = 00h)**

7	6	5	4	3	2	1	0
0	0	0	0	LOW SPEED MODE CH A	0	0	0

**Bits[7:4] Always write '0'**

**Bit 3 LOW SPEED MODE CH A: Channel A low-speed mode enable**

This bit enables the low-speed mode for channel A. Set the EN LOW SPEED MODE bit to '1' before using this bit.

0 = Low-speed mode is disabled for channel A

1 = Low-speed mode is enabled for channel A

**Bits[2:0] Always write '0'**

**TYPICAL CHARACTERISTICS: ADS4246**

At  $T_A = +25^\circ\text{C}$ ,  $AV_{DD} = 1.8\text{V}$ ,  $DRV_{DD} = 1.8\text{V}$ , maximum rated sampling frequency, sine wave input clock,  $1.5\text{V}_{PP}$  differential clock amplitude, 50% clock duty cycle,  $-1\text{dBFS}$  differential analog input, High-Performance Mode disabled,  $0\text{dB}$  gain, DDR LVDS output interface, and 32k point FFT, unless otherwise noted.

**FFT FOR 20MHz INPUT SIGNAL**

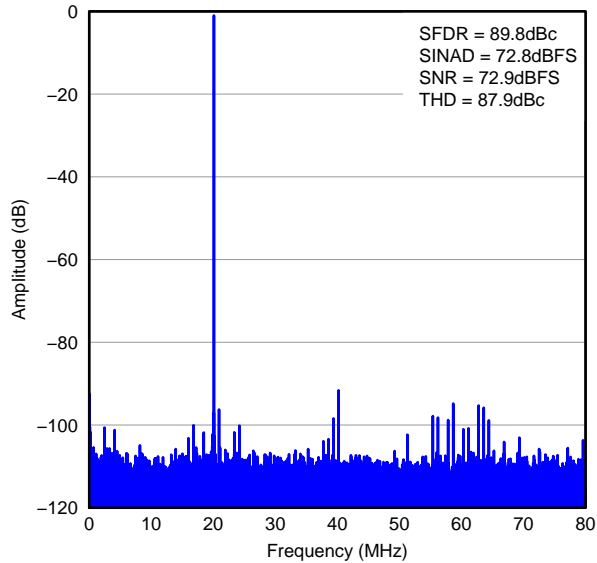

**Figure 16.**

**FFT FOR 170MHz INPUT SIGNAL**

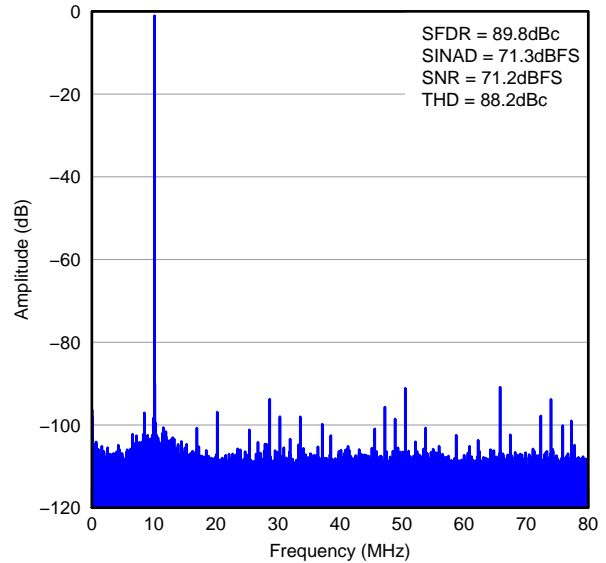

**Figure 17.**

**FFT FOR 300MHz INPUT SIGNAL**

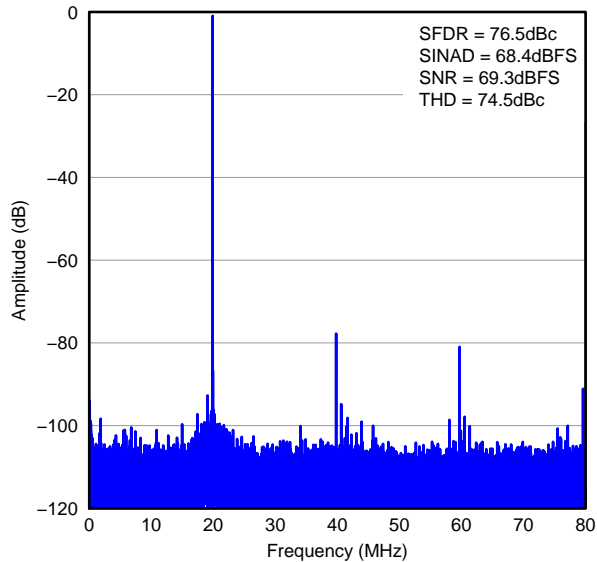

**Figure 18.**

**FFT FOR TWO-TONE INPUT SIGNAL**

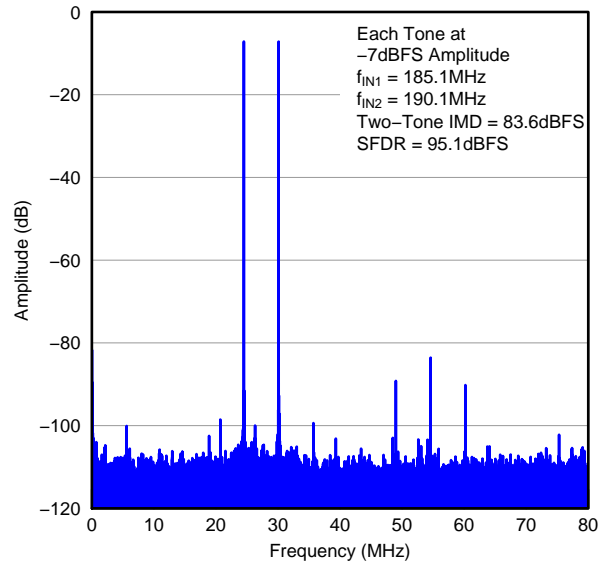
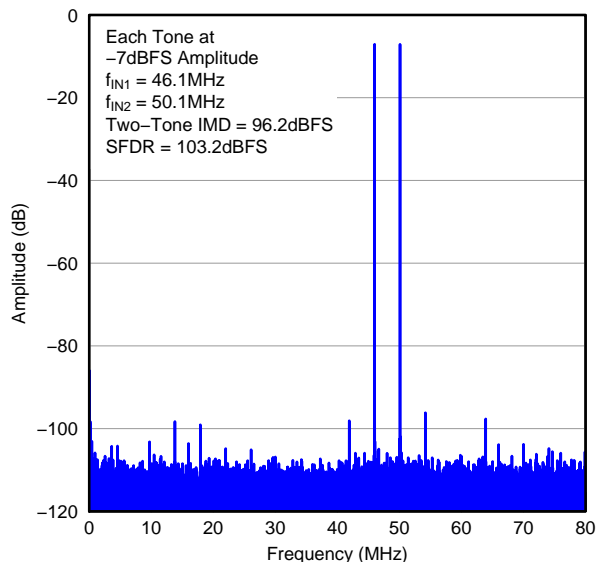

**Figure 19.**

**TYPICAL CHARACTERISTICS: ADS4246 (continued)**

At  $T_A = +25^\circ\text{C}$ ,  $AVDD = 1.8\text{V}$ ,  $DRVDD = 1.8\text{V}$ , maximum rated sampling frequency, sine wave input clock,  $1.5V_{PP}$  differential clock amplitude, 50% clock duty cycle,  $-1\text{dBFS}$  differential analog input, High-Performance Mode disabled,  $0\text{dB}$  gain, DDR LVDS output interface, and 32k point FFT, unless otherwise noted.

**FFT FOR TWO-TONE INPUT SIGNAL**



**Figure 20.**

**SFDR vs INPUT FREQUENCY**

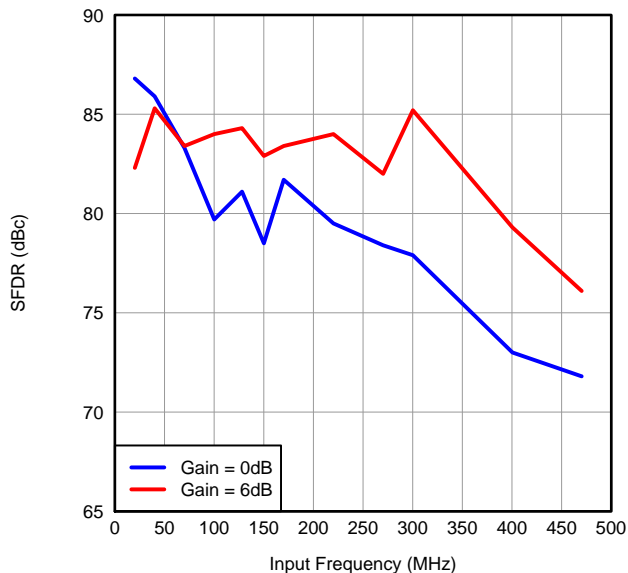

**Figure 21.**

**SNR vs INPUT FREQUENCY**

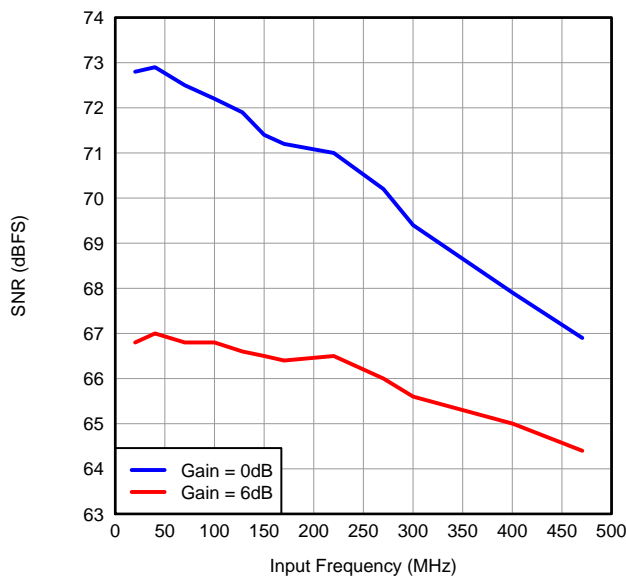

**Figure 22.**

**SNR vs INPUT FREQUENCY (CMOS)**

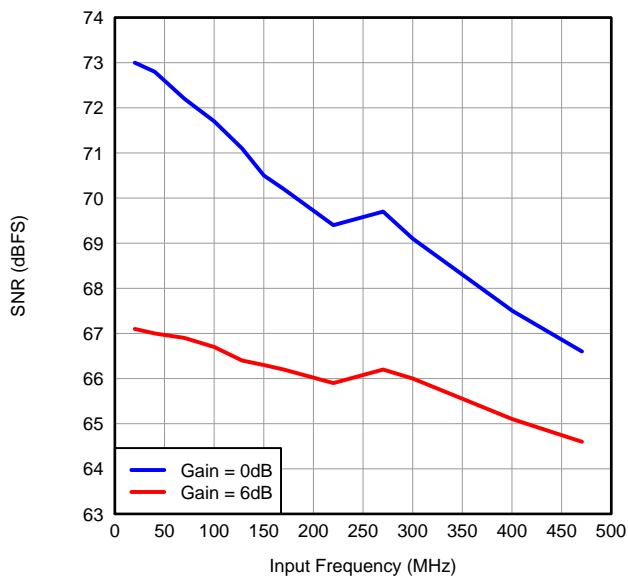

**Figure 23.**

**TYPICAL CHARACTERISTICS: ADS4246 (continued)**

At  $T_A = +25^\circ\text{C}$ ,  $AV_{DD} = 1.8\text{V}$ ,  $DRV_{DD} = 1.8\text{V}$ , maximum rated sampling frequency, sine wave input clock,  $1.5\text{V}_{PP}$  differential clock amplitude, 50% clock duty cycle,  $-1\text{dBFS}$  differential analog input, High-Performance Mode disabled, 0dB gain, DDR LVDS output interface, and 32k point FFT, unless otherwise noted.

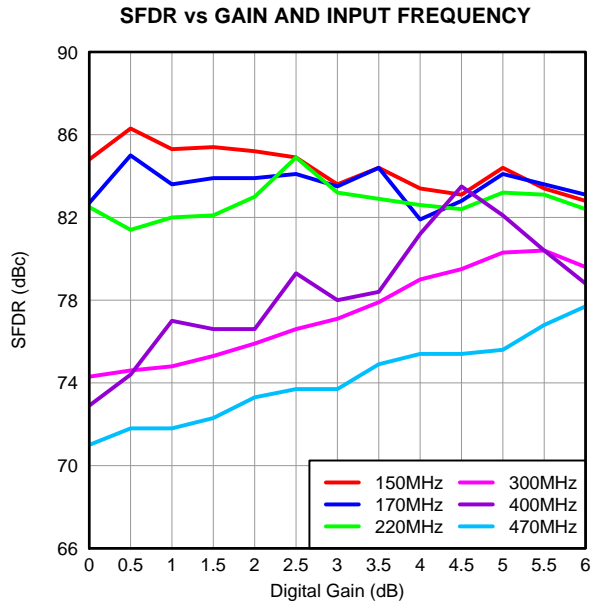

Figure 24.

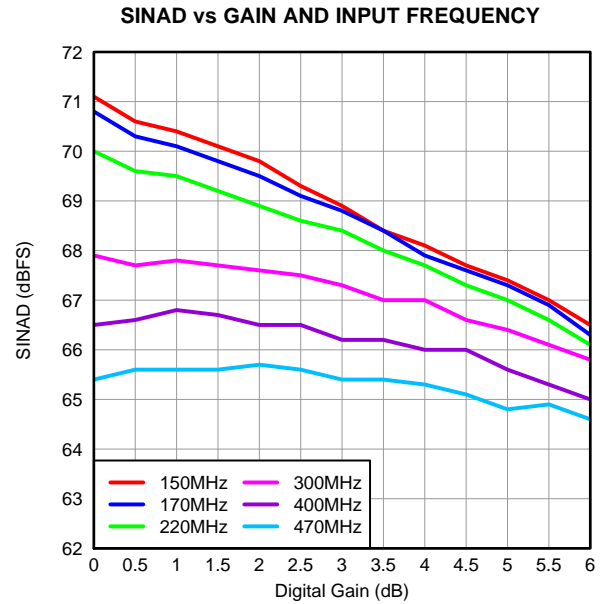

Figure 25.

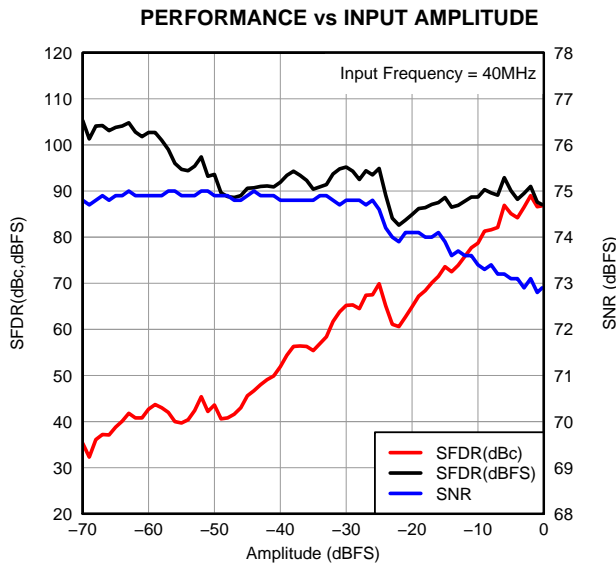

Figure 26.

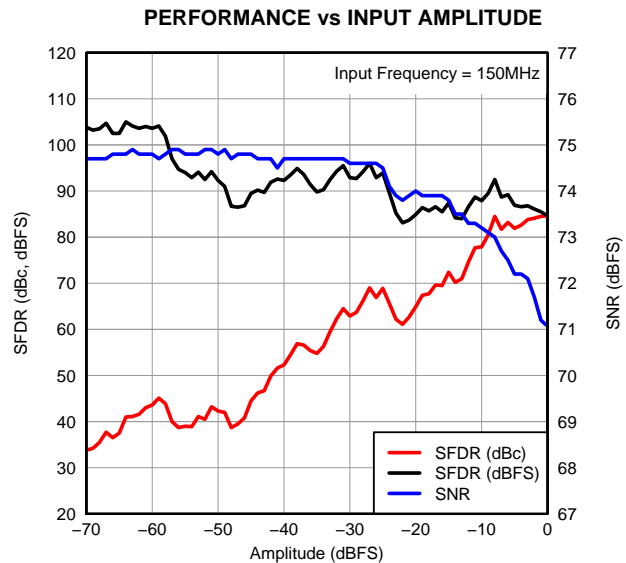

Figure 27.

**TYPICAL CHARACTERISTICS: ADS4246 (continued)**

At  $T_A = +25^\circ\text{C}$ ,  $AVDD = 1.8\text{V}$ ,  $DRVDD = 1.8\text{V}$ , maximum rated sampling frequency, sine wave input clock,  $1.5\text{V}_{PP}$  differential clock amplitude, 50% clock duty cycle,  $-1\text{dBFS}$  differential analog input, High-Performance Mode disabled, 0dB gain, DDR LVDS output interface, and 32k point FFT, unless otherwise noted.

**PERFORMANCE vs INPUT COMMON-MODE VOLTAGE**

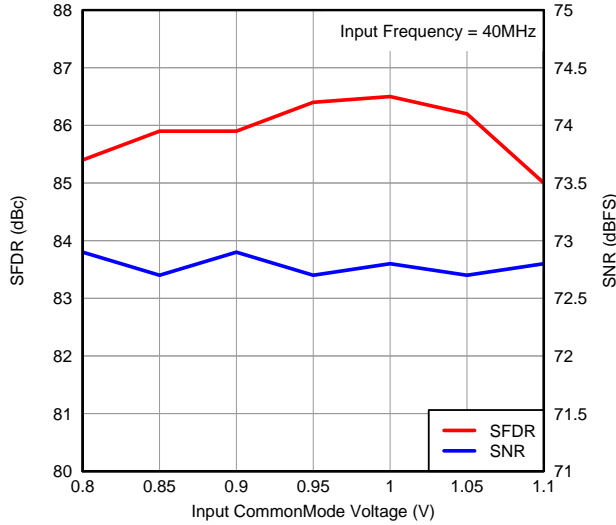

Figure 28.

**PERFORMANCE vs INPUT COMMON-MODE VOLTAGE**

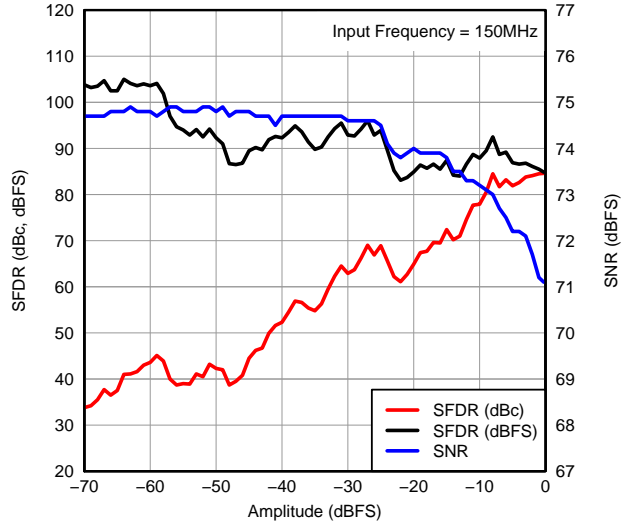

Figure 29.

**SFDR vs TEMPERATURE AND AVDD SUPPLY**

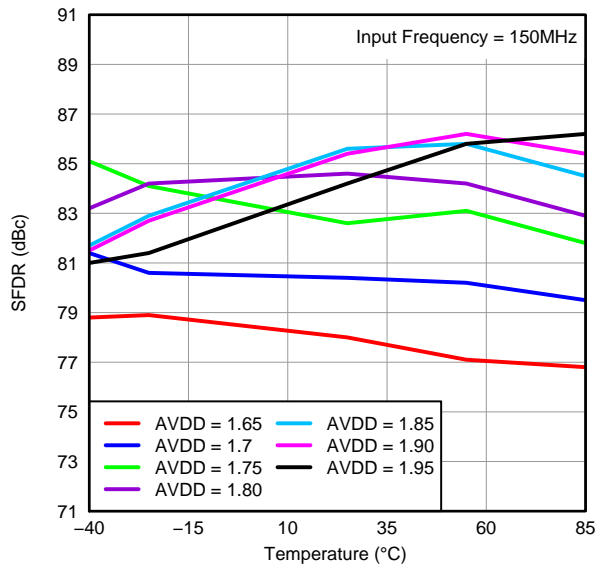

Figure 30.

**SNR vs TEMPERATURE AND AVDD SUPPLY**

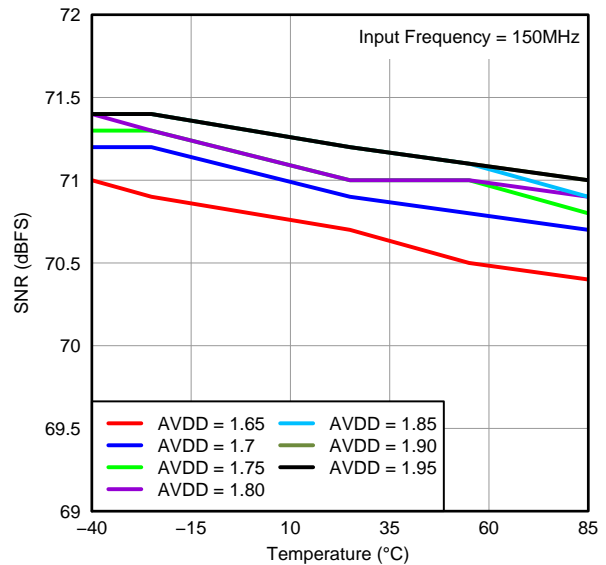

Figure 31.

**TYPICAL CHARACTERISTICS: ADS4246 (continued)**

At  $T_A = +25^\circ\text{C}$ ,  $AV_{DD} = 1.8\text{V}$ ,  $DRV_{DD} = 1.8\text{V}$ , maximum rated sampling frequency, sine wave input clock,  $1.5V_{PP}$  differential clock amplitude, 50% clock duty cycle,  $-1\text{dBFS}$  differential analog input, High-Performance Mode disabled,  $0\text{dB}$  gain, DDR LVDS output interface, and 32k point FFT, unless otherwise noted.

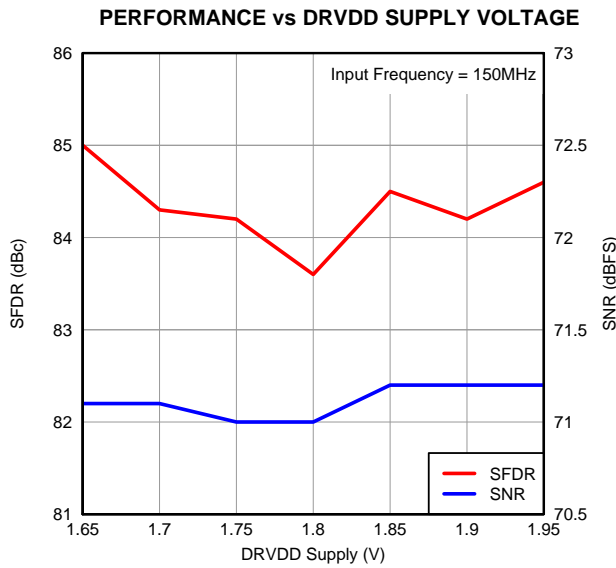

Figure 32.

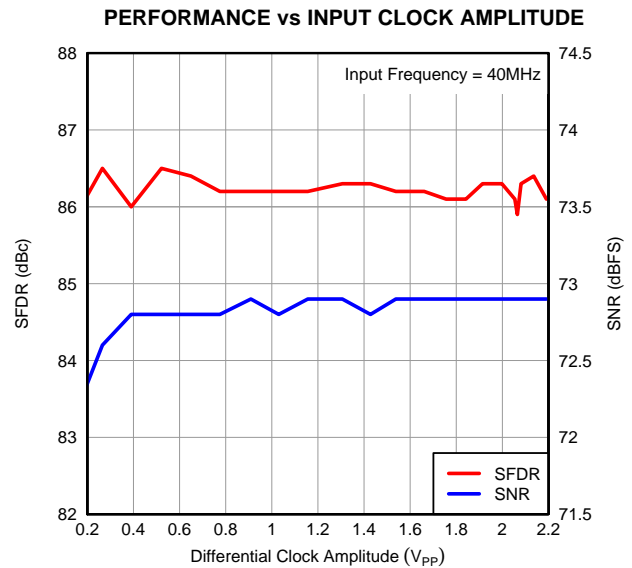

Figure 33.

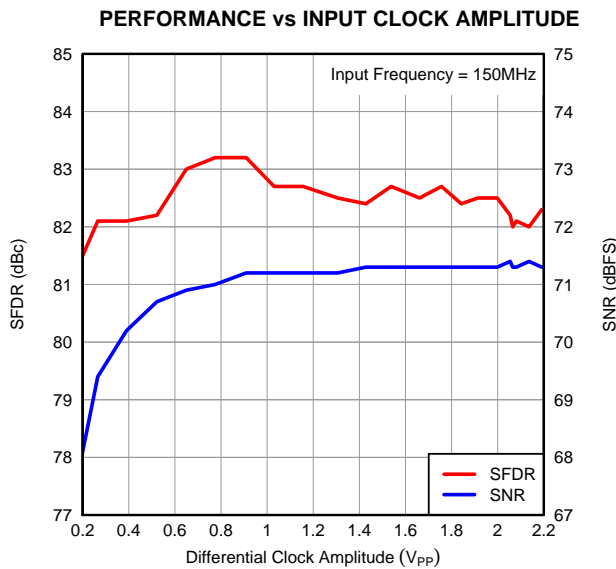

Figure 34.

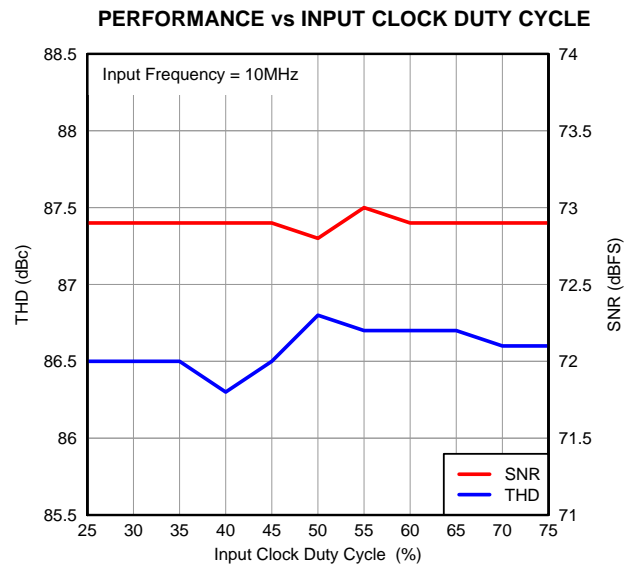

Figure 35.

**TYPICAL CHARACTERISTICS: ADS4246 (continued)**

At  $T_A = +25^\circ\text{C}$ ,  $AVDD = 1.8\text{V}$ ,  $DRVDD = 1.8\text{V}$ , maximum rated sampling frequency, sine wave input clock,  $1.5V_{PP}$  differential clock amplitude, 50% clock duty cycle,  $-1\text{dBFS}$  differential analog input, High-Performance Mode disabled, 0dB gain, DDR LVDS output interface, and 32k point FFT, unless otherwise noted.

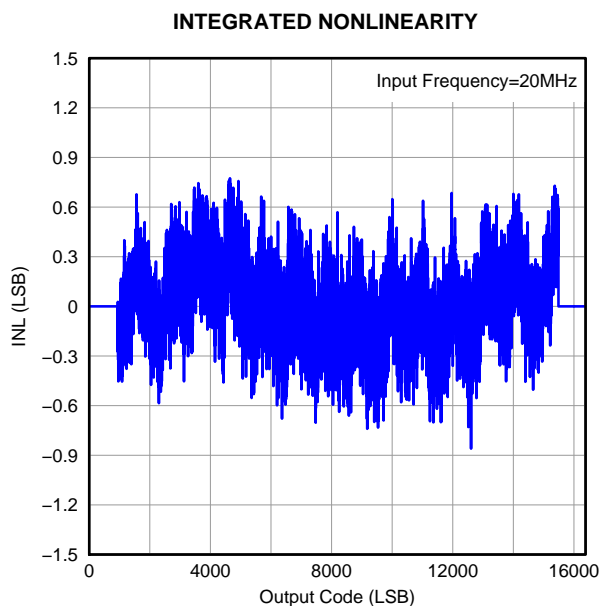

Figure 36.

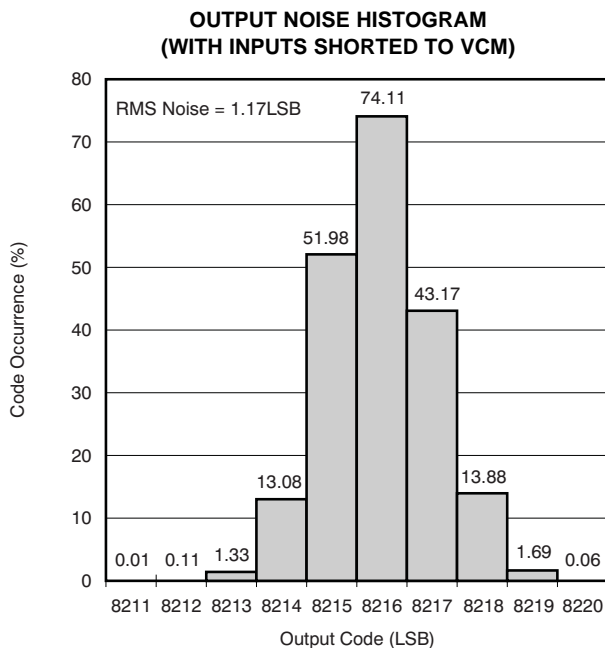
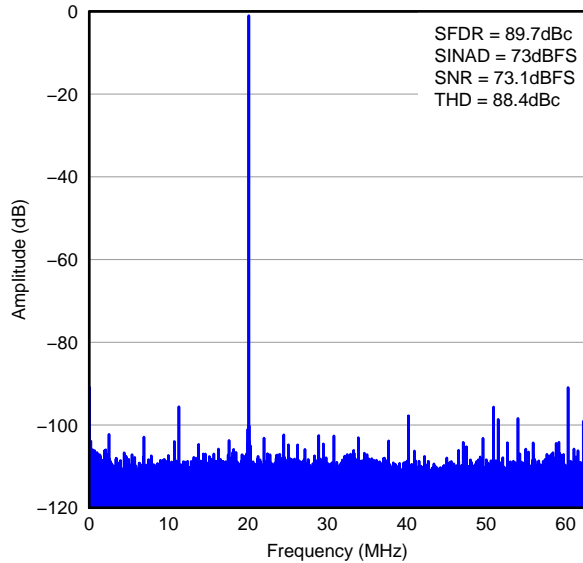

Figure 37.

**TYPICAL CHARACTERISTICS: ADS4245**

At  $T_A = +25^\circ\text{C}$ ,  $AVDD = 1.8\text{V}$ ,  $DRVDD = 1.8\text{V}$ , maximum rated sampling frequency, sine wave input clock,  $1.5\text{V}_{PP}$  differential clock amplitude, 50% clock duty cycle,  $-1\text{dBFS}$  differential analog input, High-Performance Mode disabled,  $0\text{dB}$  gain, DDR LVDS output interface, and 32k point FFT, unless otherwise noted.

**FFT FOR 20MHz INPUT SIGNAL**



**Figure 38.**

**FFT FOR 170MHz INPUT SIGNAL**

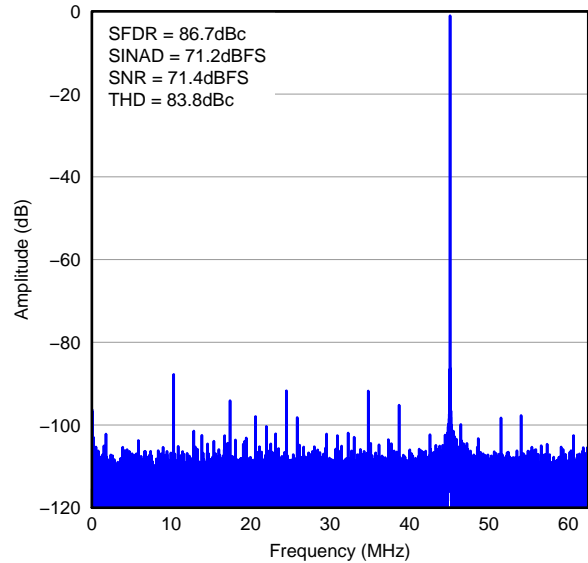

**Figure 39.**

**FFT FOR 300MHz INPUT SIGNAL**

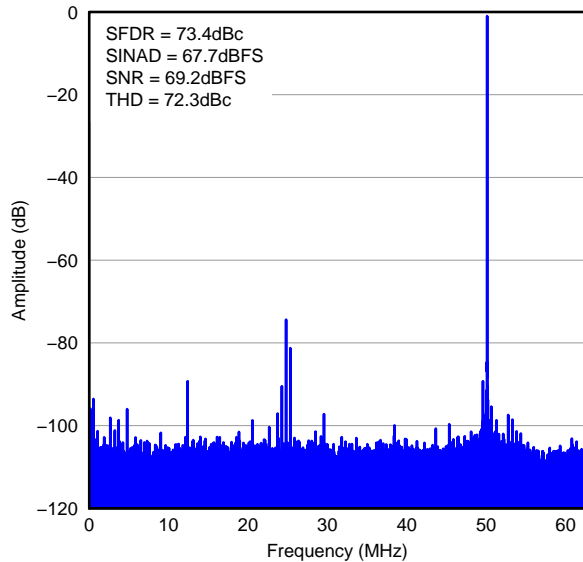

**Figure 40.**

**FFT FOR TWO-TONE INPUT SIGNAL**

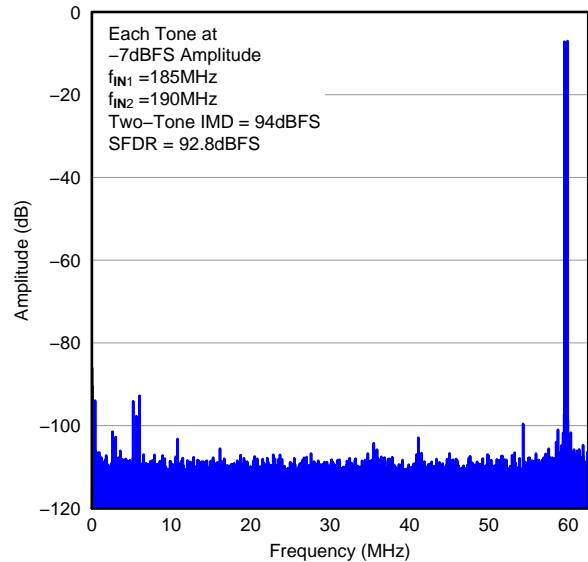
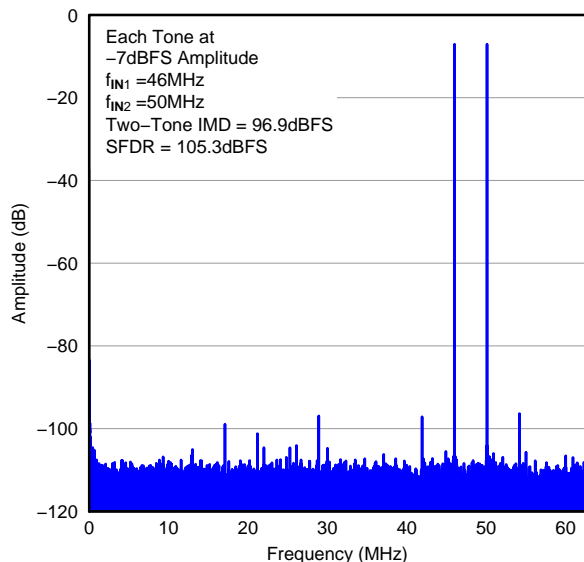

**Figure 41.**

**TYPICAL CHARACTERISTICS: ADS4245 (continued)**

At  $T_A = +25^\circ\text{C}$ ,  $AVDD = 1.8\text{V}$ ,  $DRVDD = 1.8\text{V}$ , maximum rated sampling frequency, sine wave input clock,  $1.5\text{V}_{PP}$  differential clock amplitude, 50% clock duty cycle,  $-1\text{dBFS}$  differential analog input, High-Performance Mode disabled,  $0\text{dB}$  gain, DDR LVDS output interface, and 32k point FFT, unless otherwise noted.

**FFT FOR TWO-TONE INPUT SIGNAL**



**Figure 42.**

**SFDR vs INPUT FREQUENCY**

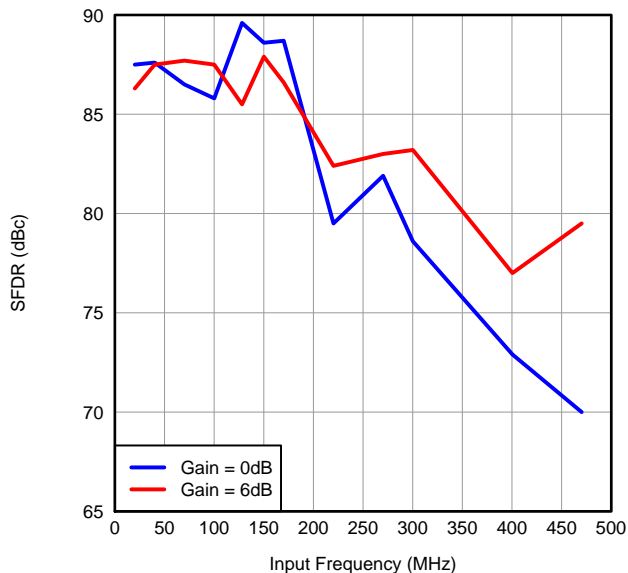

**Figure 43.**

**SNR vs INPUT FREQUENCY**

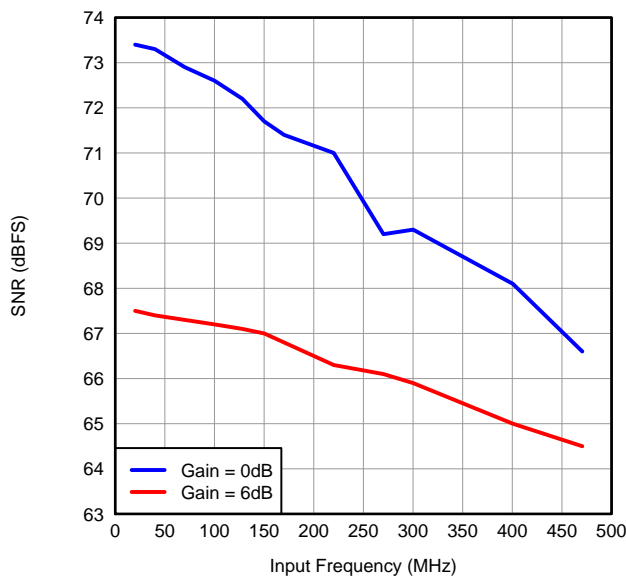

**Figure 44.**

**SNR vs INPUT FREQUENCY (CMOS)**

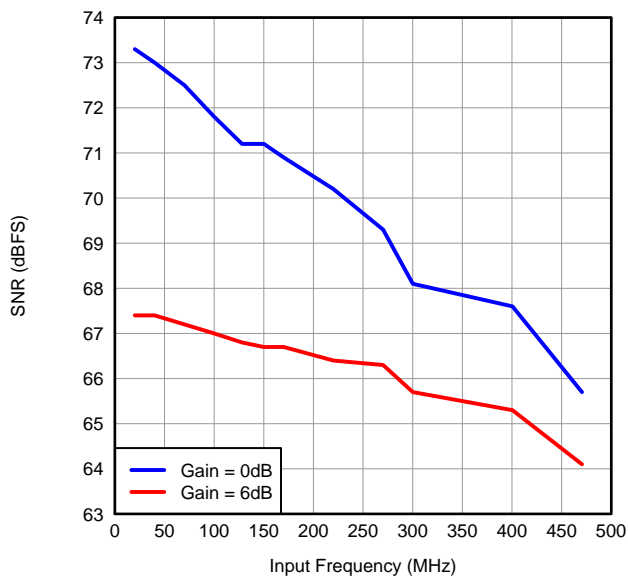

**Figure 45.**

**TYPICAL CHARACTERISTICS: ADS4245 (continued)**

At  $T_A = +25^\circ\text{C}$ ,  $AV_{DD} = 1.8\text{V}$ ,  $DRV_{DD} = 1.8\text{V}$ , maximum rated sampling frequency, sine wave input clock,  $1.5\text{V}_{PP}$  differential clock amplitude, 50% clock duty cycle,  $-1\text{dBFS}$  differential analog input, High-Performance Mode disabled,  $0\text{dB}$  gain, DDR LVDS output interface, and 32k point FFT, unless otherwise noted.

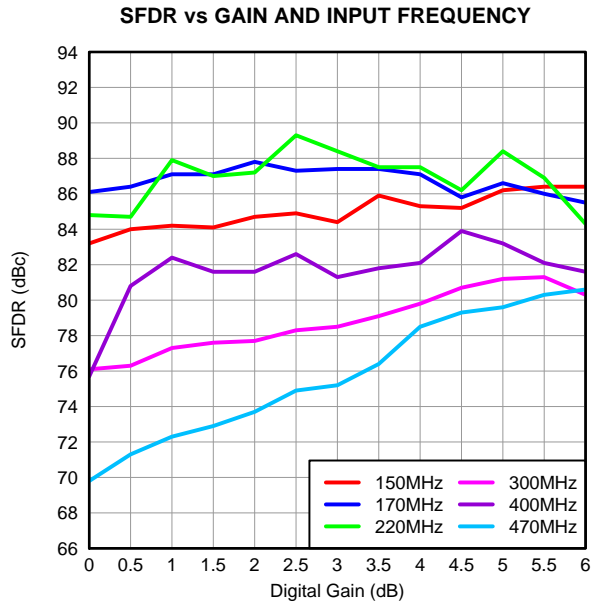

Figure 46.

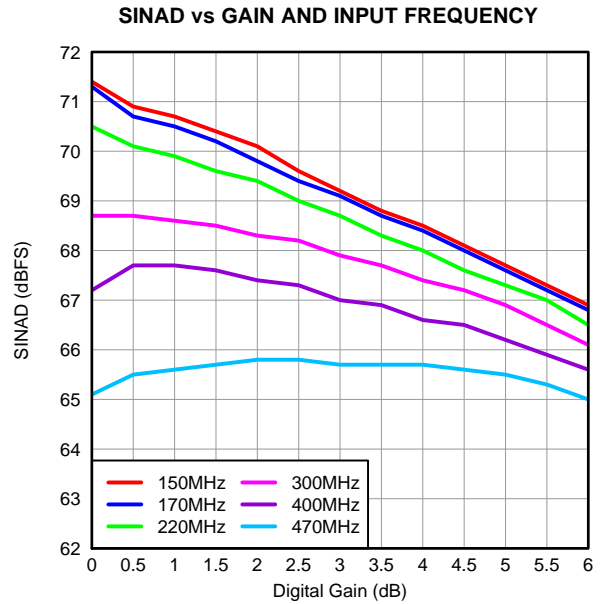

Figure 47.

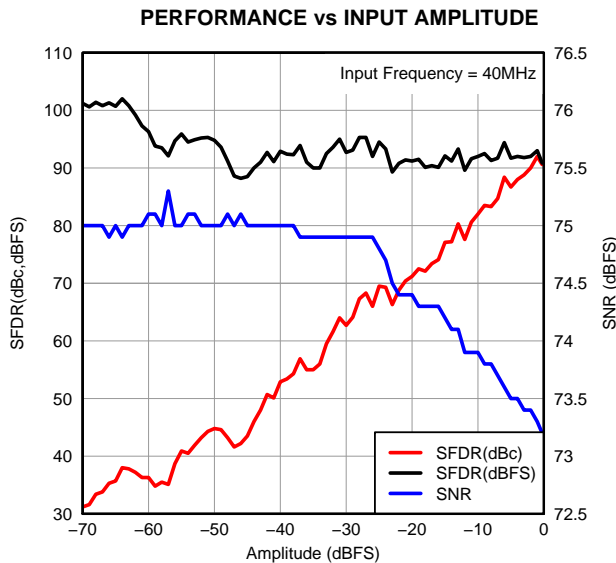

Figure 48.

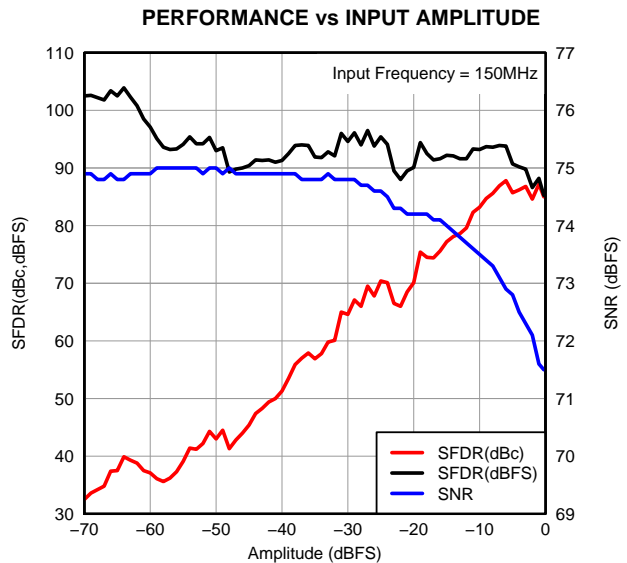

Figure 49.

**TYPICAL CHARACTERISTICS: ADS4245 (continued)**

At  $T_A = +25^\circ\text{C}$ ,  $AVDD = 1.8\text{V}$ ,  $DRVDD = 1.8\text{V}$ , maximum rated sampling frequency, sine wave input clock,  $1.5\text{V}_{PP}$  differential clock amplitude, 50% clock duty cycle,  $-1\text{dBFS}$  differential analog input, High-Performance Mode disabled, 0dB gain, DDR LVDS output interface, and 32k point FFT, unless otherwise noted.

**PERFORMANCE vs INPUT COMMON-MODE VOLTAGE**

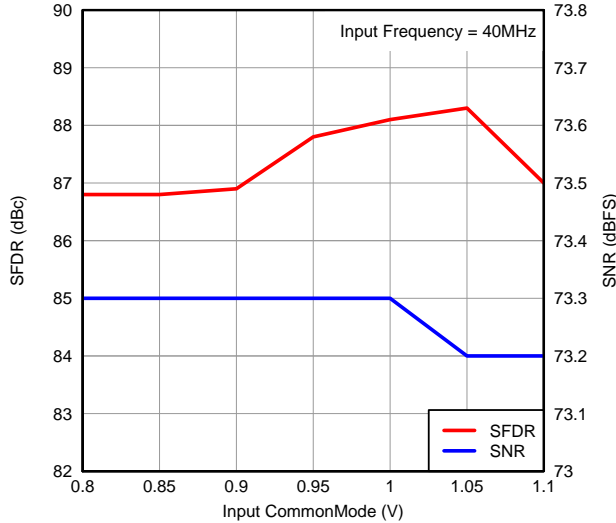

Figure 50.

**PERFORMANCE vs INPUT COMMON-MODE VOLTAGE**

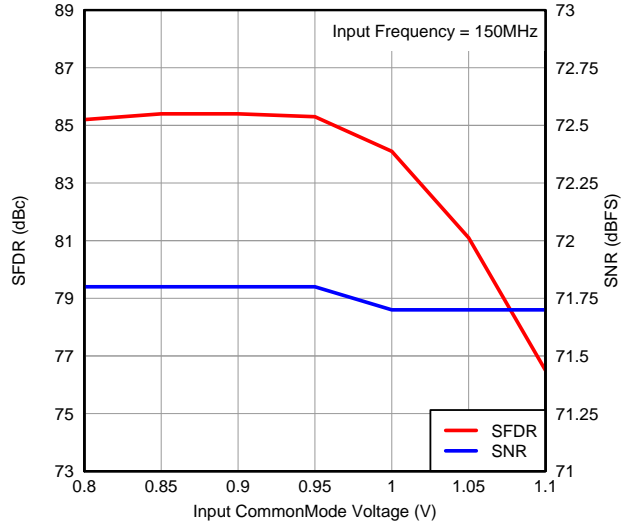

Figure 51.

**SFDR vs TEMPERATURE AND AVDD SUPPLY**

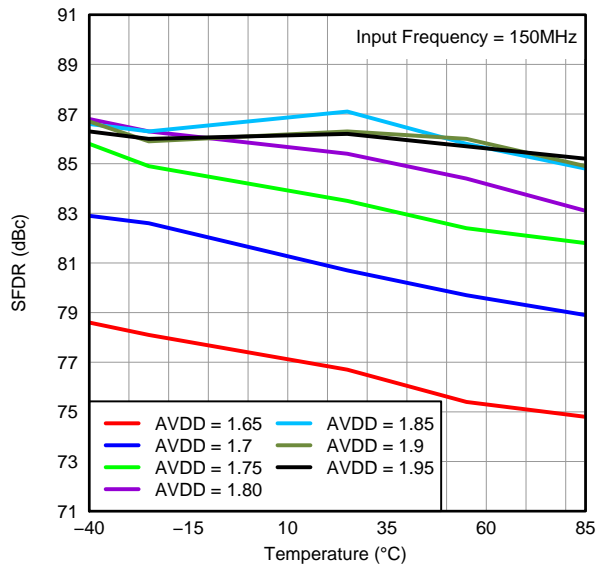

Figure 52.

**SNR vs TEMPERATURE AND AVDD SUPPLY**

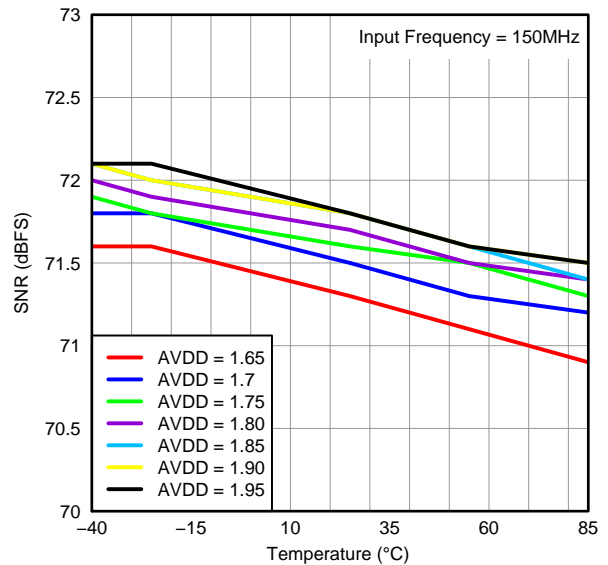

Figure 53.

**TYPICAL CHARACTERISTICS: ADS4245 (continued)**

At  $T_A = +25^\circ\text{C}$ ,  $AVDD = 1.8\text{V}$ ,  $DRVDD = 1.8\text{V}$ , maximum rated sampling frequency, sine wave input clock,  $1.5V_{PP}$  differential clock amplitude, 50% clock duty cycle,  $-1\text{dBFS}$  differential analog input, High-Performance Mode disabled, 0dB gain, DDR LVDS output interface, and 32k point FFT, unless otherwise noted.

**PERFORMANCE vs DRVDD SUPPLY VOLTAGE**

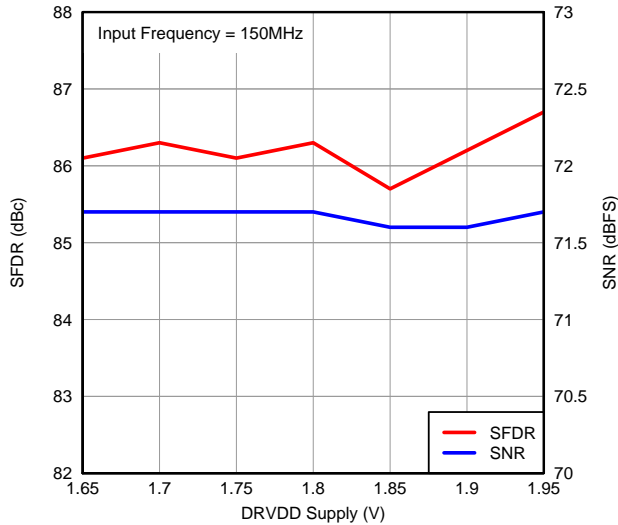

Figure 54.

**PERFORMANCE vs INPUT CLOCK AMPLITUDE**

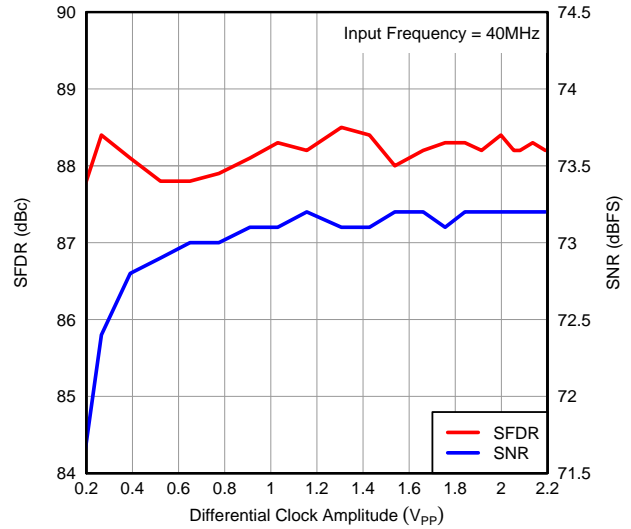

Figure 55.

**PERFORMANCE vs INPUT CLOCK AMPLITUDE**

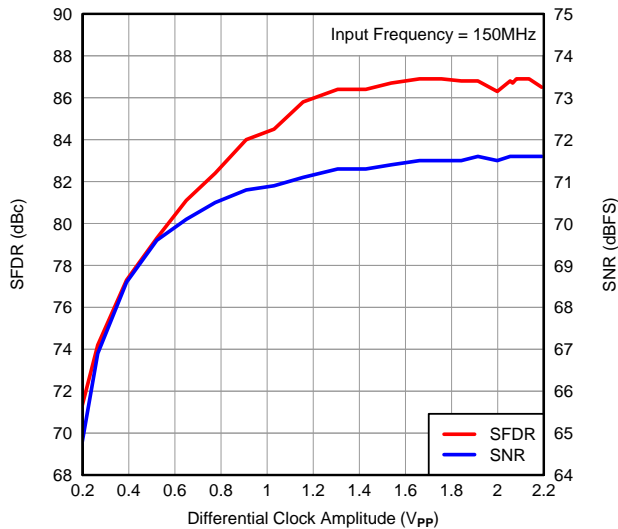

Figure 56.

**PERFORMANCE vs INPUT CLOCK DUTY CYCLE**

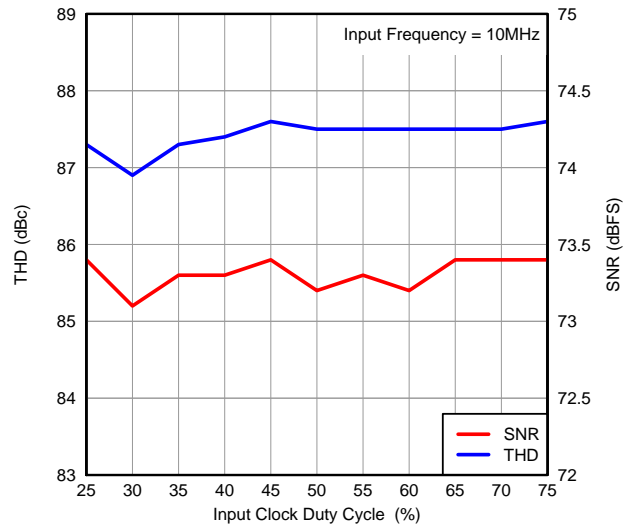

Figure 57.

**TYPICAL CHARACTERISTICS: ADS4245 (continued)**

At  $T_A = +25^\circ\text{C}$ ,  $AVDD = 1.8\text{V}$ ,  $DRVDD = 1.8\text{V}$ , maximum rated sampling frequency, sine wave input clock,  $1.5V_{PP}$  differential clock amplitude, 50% clock duty cycle,  $-1\text{dBFS}$  differential analog input, High-Performance Mode disabled, 0dB gain, DDR LVDS output interface, and 32k point FFT, unless otherwise noted.

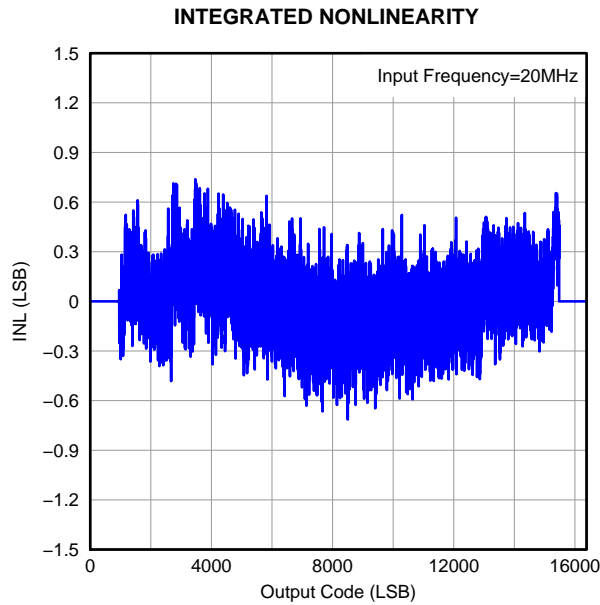

Figure 58.

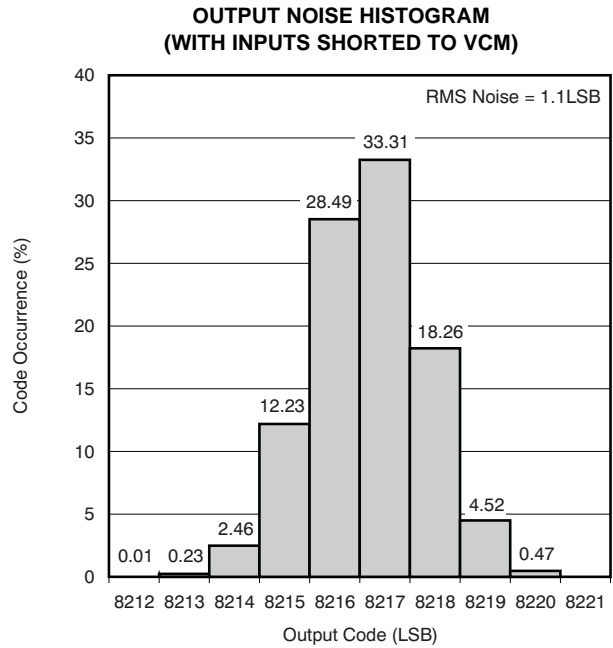
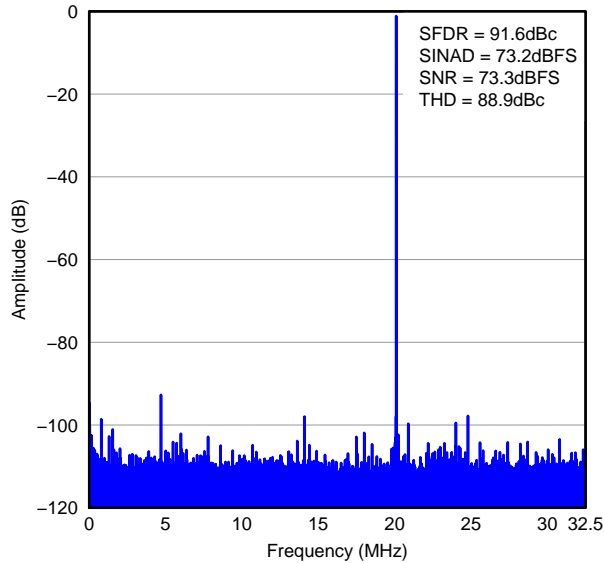

Figure 59.

**TYPICAL CHARACTERISTICS: ADS4242**

At  $T_A = +25^\circ\text{C}$ ,  $AVDD = 1.8\text{V}$ ,  $DRVDD = 1.8\text{V}$ , maximum rated sampling frequency, sine wave input clock,  $1.5\text{V}_{PP}$  differential clock amplitude, 50% clock duty cycle,  $-1\text{dBFS}$  differential analog input, High-Performance Mode disabled,  $0\text{dB}$  gain, DDR LVDS output interface, and 32k point FFT, unless otherwise noted.

**FFT FOR 20MHz INPUT SIGNAL**



**Figure 60.**

**FFT FOR 170MHz INPUT SIGNAL**

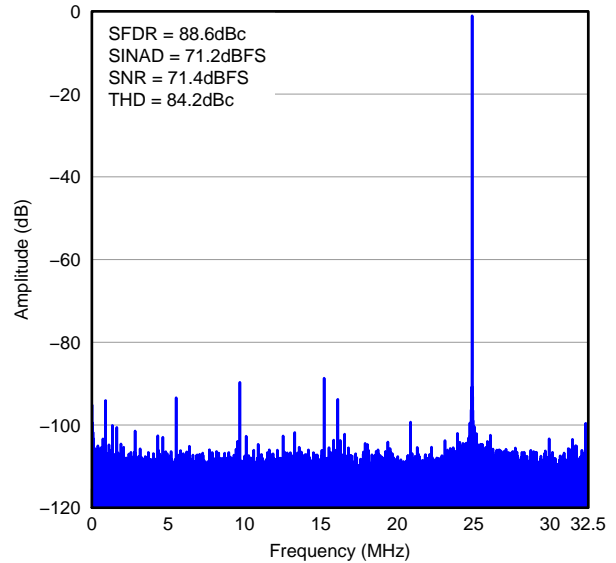

**Figure 61.**

**FFT FOR 300MHz INPUT SIGNAL**

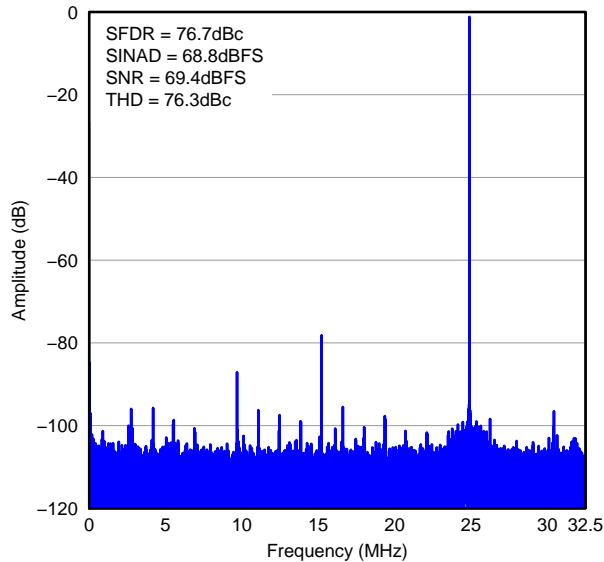

**Figure 62.**

**FFT FOR TWO-TONE INPUT SIGNAL**

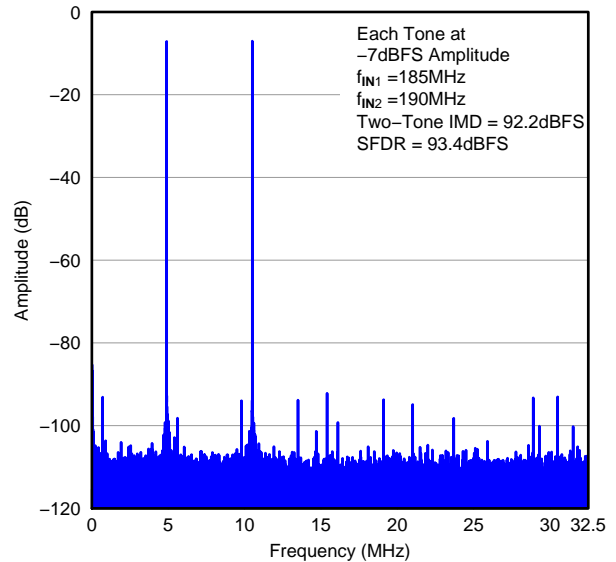
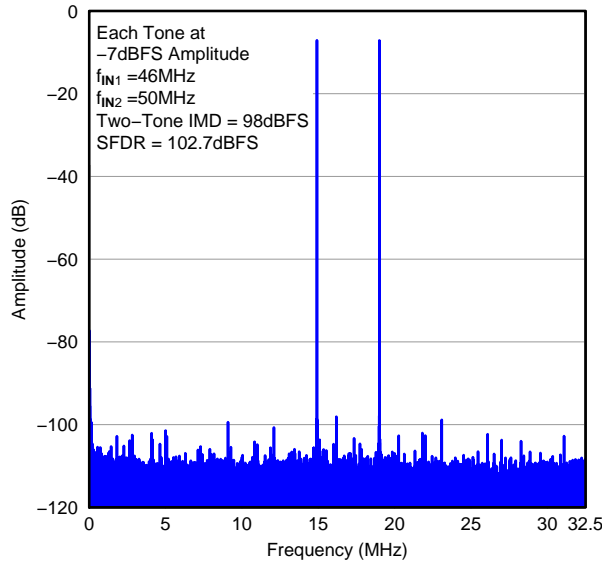

**Figure 63.**

**TYPICAL CHARACTERISTICS: ADS4242 (continued)**

At  $T_A = +25^\circ\text{C}$ ,  $AV_{DD} = 1.8\text{V}$ ,  $DRV_{DD} = 1.8\text{V}$ , maximum rated sampling frequency, sine wave input clock,  $1.5\text{V}_{PP}$  differential clock amplitude, 50% clock duty cycle,  $-1\text{dBFS}$  differential analog input, High-Performance Mode disabled,  $0\text{dB}$  gain, DDR LVDS output interface, and 32k point FFT, unless otherwise noted.

**FFT FOR TWO-TONE INPUT SIGNAL**



**Figure 64.**

**SFDR vs INPUT FREQUENCY**

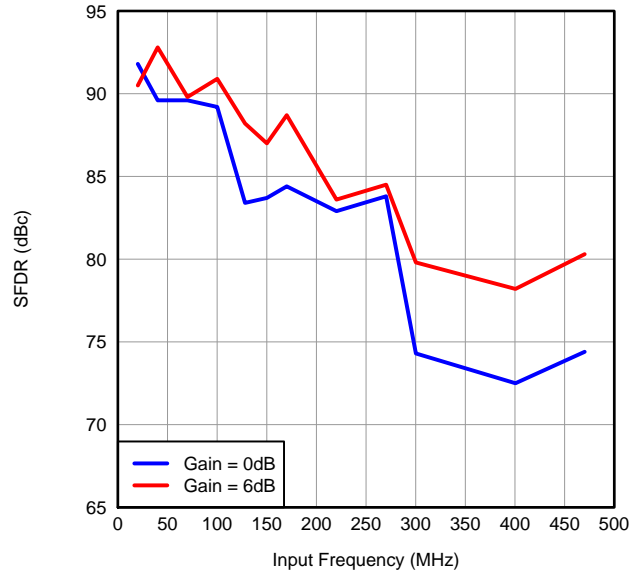

**Figure 65.**

**SNR vs INPUT FREQUENCY**

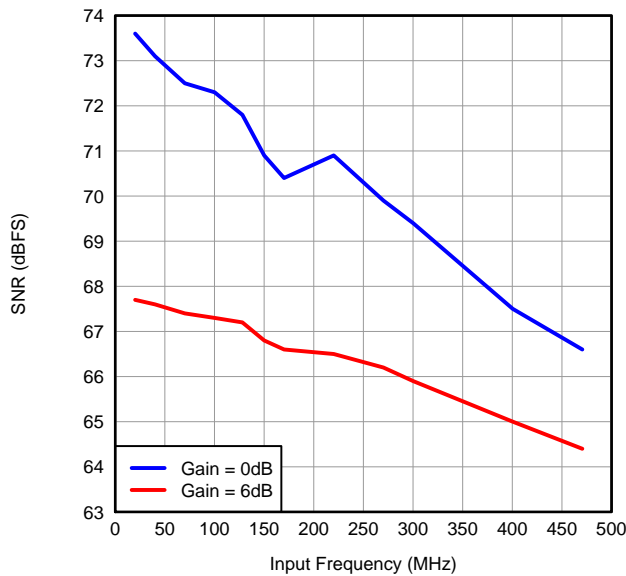

**Figure 66.**

**SNR vs INPUT FREQUENCY (CMOS)**

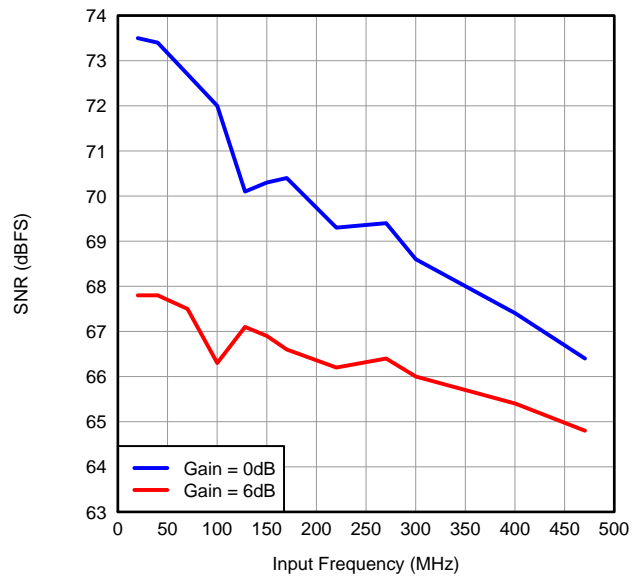

**Figure 67.**

**TYPICAL CHARACTERISTICS: ADS4242 (continued)**

At  $T_A = +25^\circ\text{C}$ ,  $AV_{DD} = 1.8\text{V}$ ,  $DRV_{DD} = 1.8\text{V}$ , maximum rated sampling frequency, sine wave input clock,  $1.5\text{V}_{PP}$  differential clock amplitude, 50% clock duty cycle,  $-1\text{dBFS}$  differential analog input, High-Performance Mode disabled, 0dB gain, DDR LVDS output interface, and 32k point FFT, unless otherwise noted.

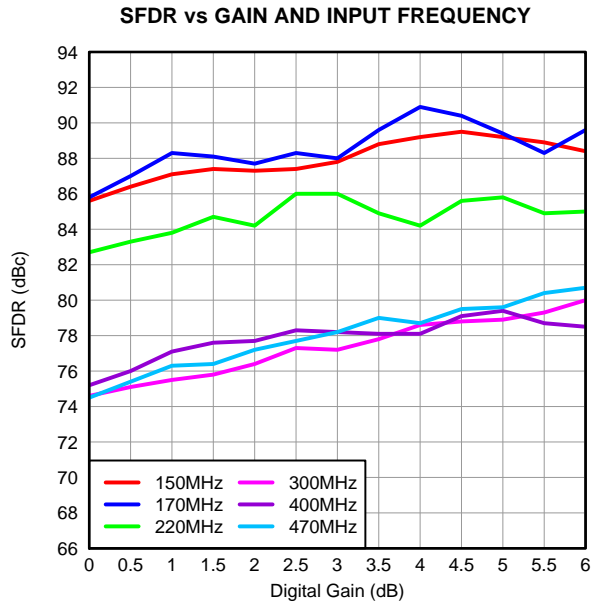

Figure 68.

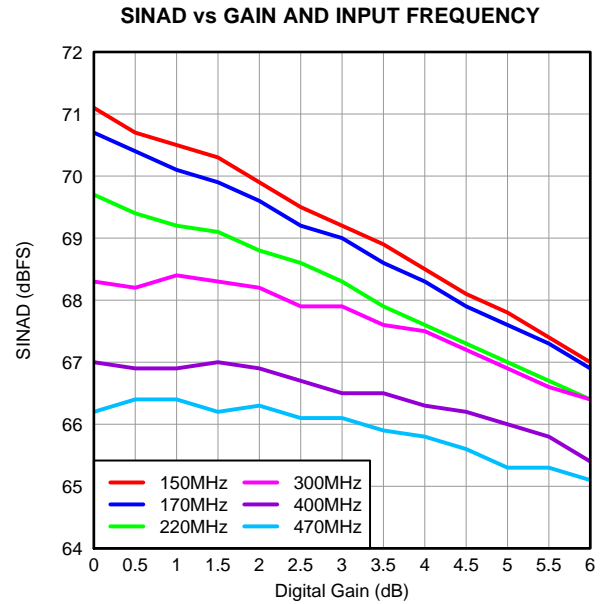

Figure 69.

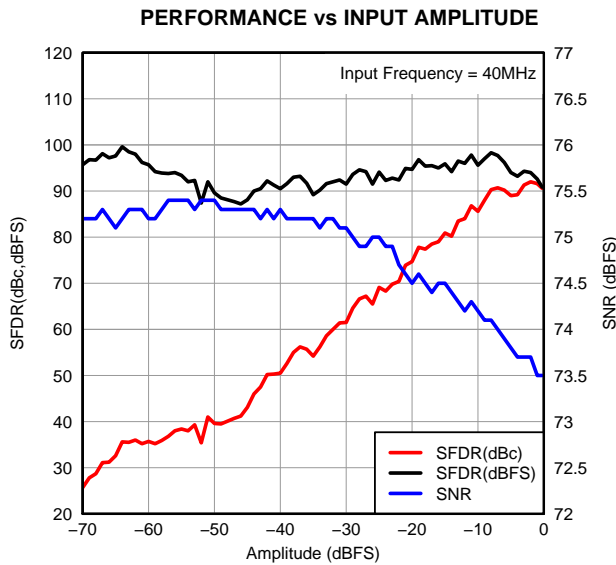

Figure 70.

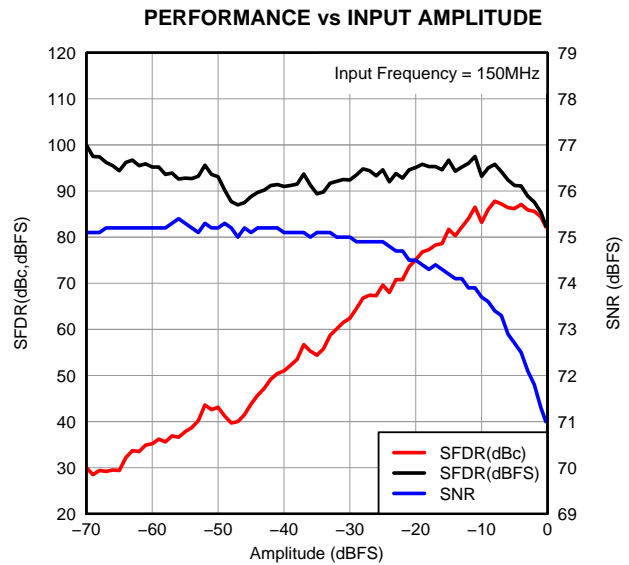

Figure 71.

**TYPICAL CHARACTERISTICS: ADS4242 (continued)**

At  $T_A = +25^\circ\text{C}$ ,  $AVDD = 1.8\text{V}$ ,  $DRVDD = 1.8\text{V}$ , maximum rated sampling frequency, sine wave input clock,  $1.5V_{PP}$  differential clock amplitude, 50% clock duty cycle,  $-1\text{dBFS}$  differential analog input, High-Performance Mode disabled, 0dB gain, DDR LVDS output interface, and 32k point FFT, unless otherwise noted.

**PERFORMANCE vs INPUT COMMON-MODE VOLTAGE**

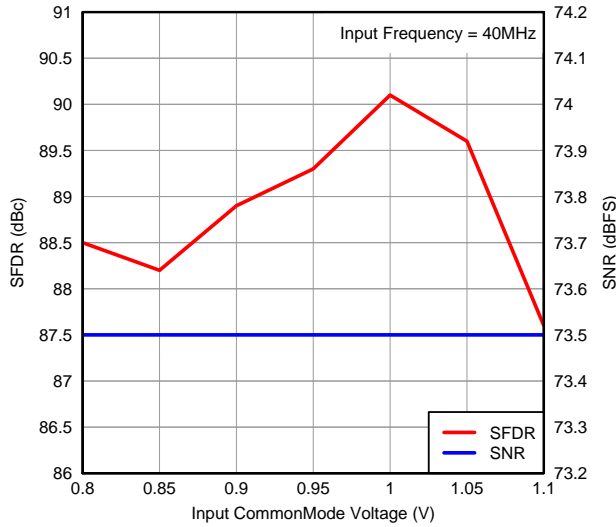

Figure 72.

**PERFORMANCE vs INPUT COMMON-MODE VOLTAGE**

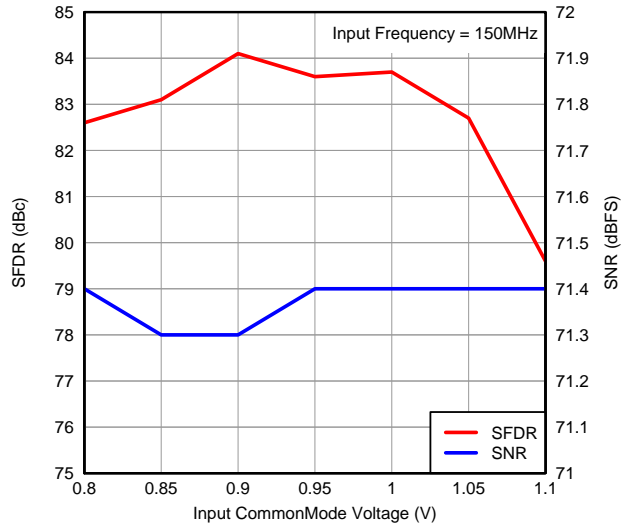

Figure 73.

**SFDR vs TEMPERATURE AND AVDD SUPPLY**

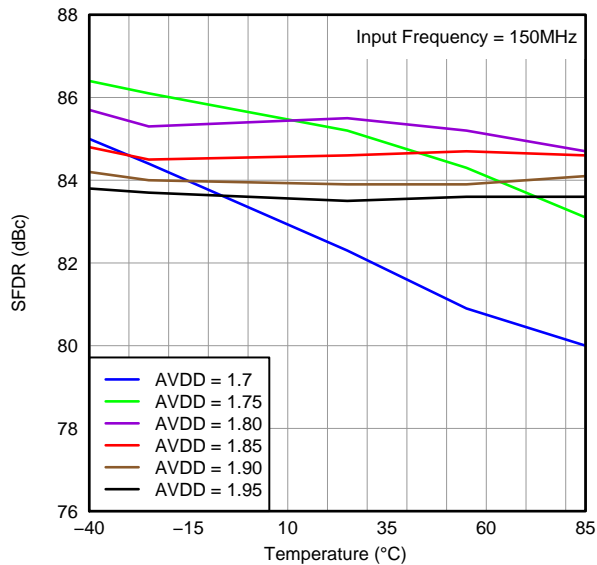

Figure 74.

**SNR vs TEMPERATURE AND AVDD SUPPLY**

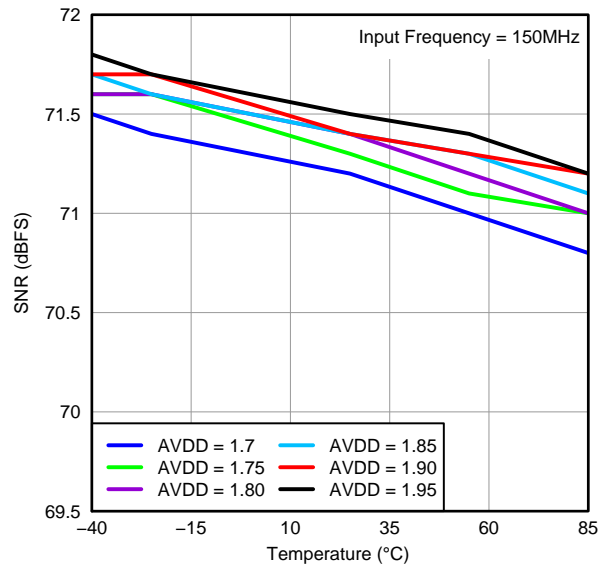

Figure 75.

**TYPICAL CHARACTERISTICS: ADS4242 (continued)**

At  $T_A = +25^\circ\text{C}$ ,  $AVDD = 1.8\text{V}$ ,  $DRVDD = 1.8\text{V}$ , maximum rated sampling frequency, sine wave input clock,  $1.5V_{PP}$  differential clock amplitude, 50% clock duty cycle,  $-1\text{dBFS}$  differential analog input, High-Performance Mode disabled,  $0\text{dB}$  gain, DDR LVDS output interface, and 32k point FFT, unless otherwise noted.

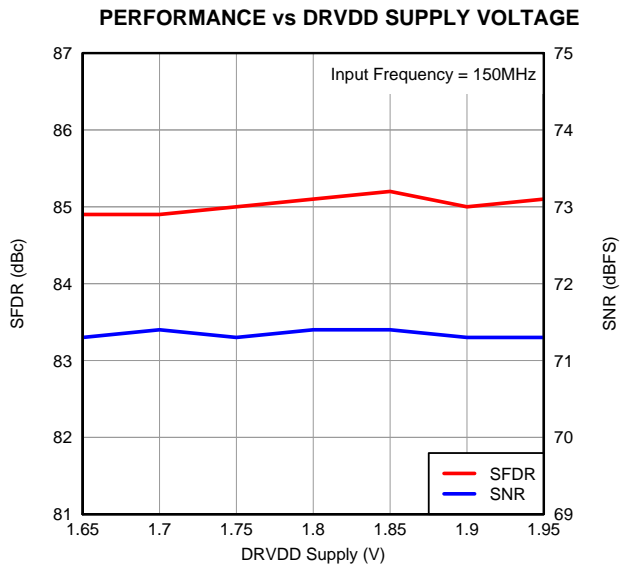

Figure 76.

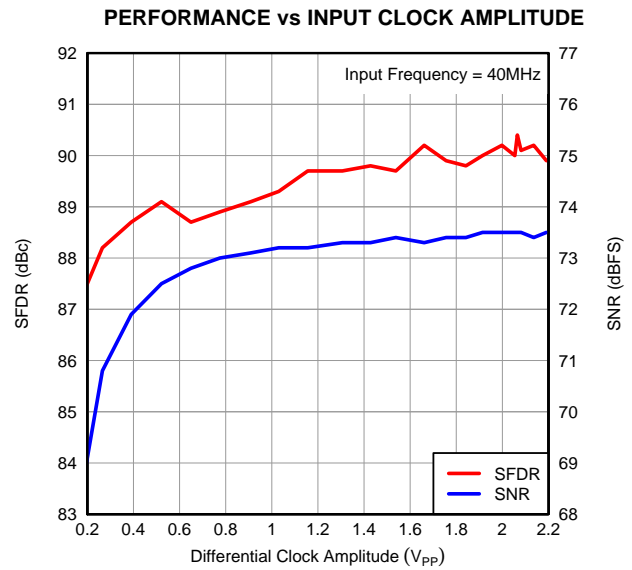

Figure 77.

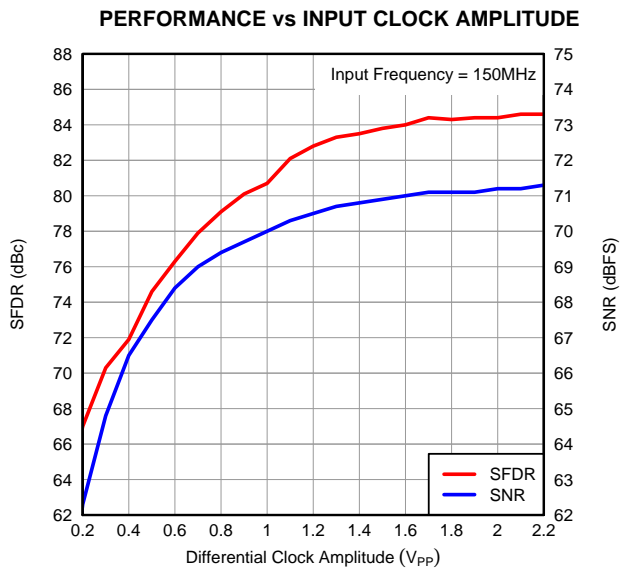

Figure 78.

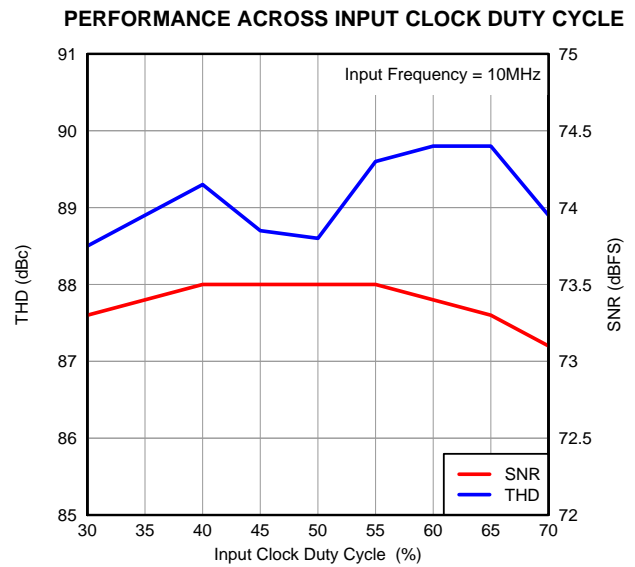
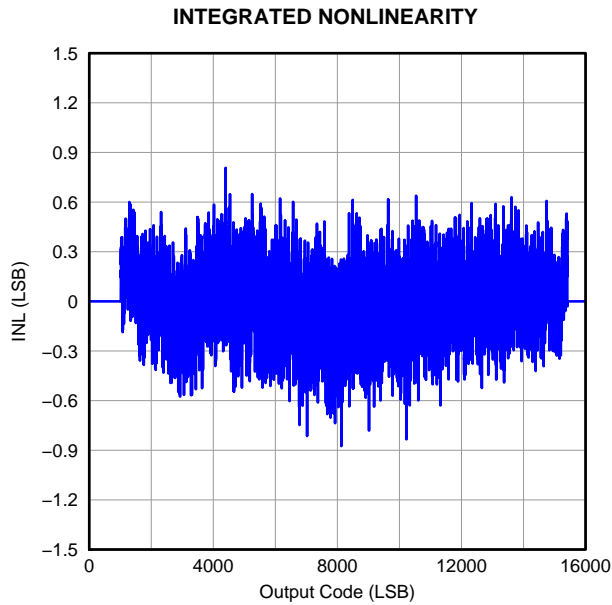

Figure 79.

**TYPICAL CHARACTERISTICS: ADS4242 (continued)**

At  $T_A = +25^\circ\text{C}$ ,  $AVDD = 1.8\text{V}$ ,  $DRVDD = 1.8\text{V}$ , maximum rated sampling frequency, sine wave input clock,  $1.5V_{PP}$  differential clock amplitude, 50% clock duty cycle,  $-1\text{dBFS}$  differential analog input, High-Performance Mode disabled, 0dB gain, DDR LVDS output interface, and 32k point FFT, unless otherwise noted.



**Figure 80.**

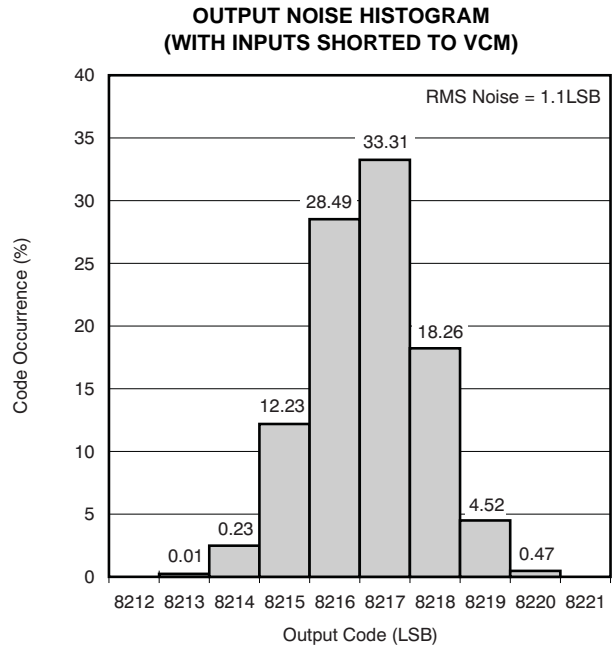
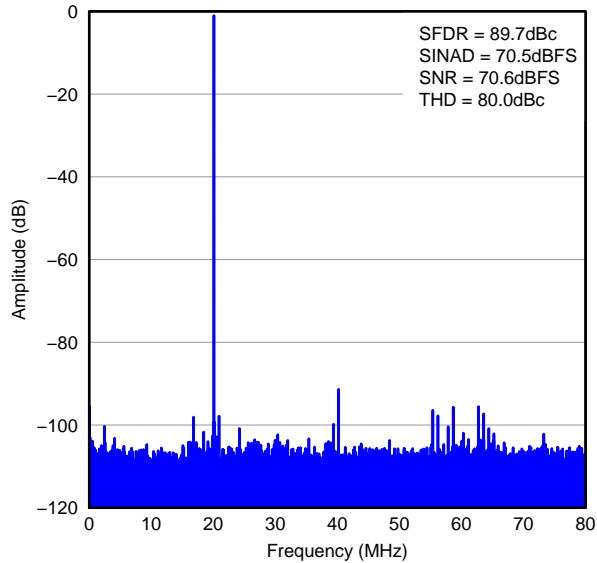

**Figure 81.**

**TYPICAL CHARACTERISTICS: ADS4226**

At  $T_A = +25^\circ\text{C}$ ,  $AV_{DD} = 1.8\text{V}$ ,  $DRV_{DD} = 1.8\text{V}$ , maximum rated sampling frequency, sine wave input clock,  $1.5\text{V}_{PP}$  differential clock amplitude, 50% clock duty cycle,  $-1\text{dBFS}$  differential analog input, High-Performance Mode disabled,  $0\text{dB}$  gain, DDR LVDS output interface, and 32k point FFT, unless otherwise noted.

**FFT FOR 20MHz INPUT SIGNAL**



**Figure 82.**

**FFT FOR 170MHz INPUT SIGNAL**

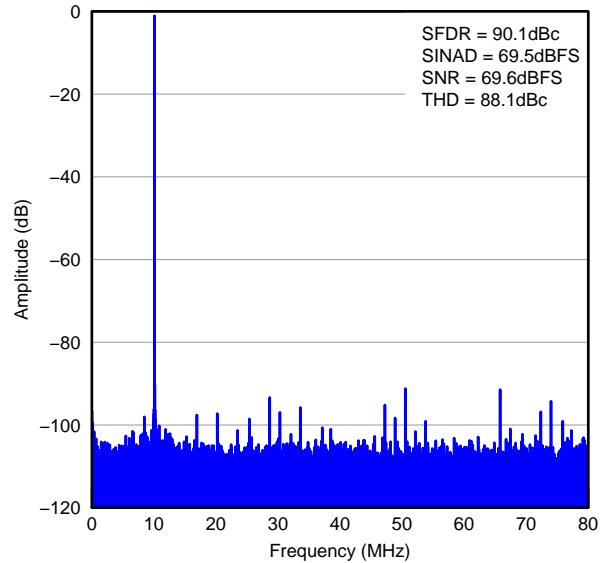

**Figure 83.**

**FFT FOR 300MHz INPUT SIGNAL**

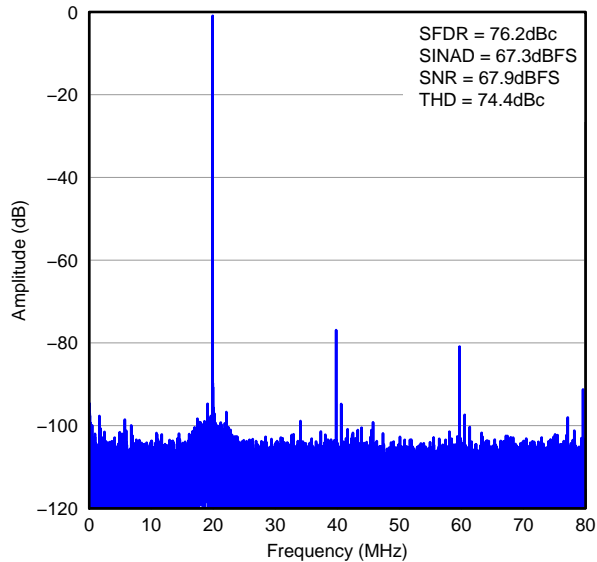

**Figure 84.**

**FFT FOR TWO-TONE INPUT SIGNAL**

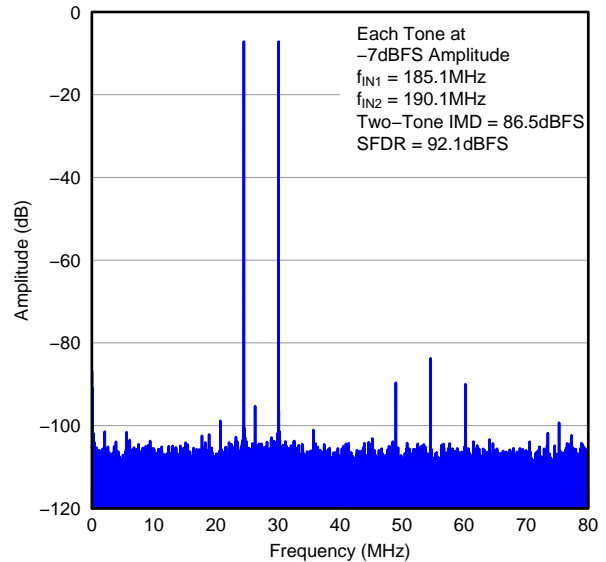
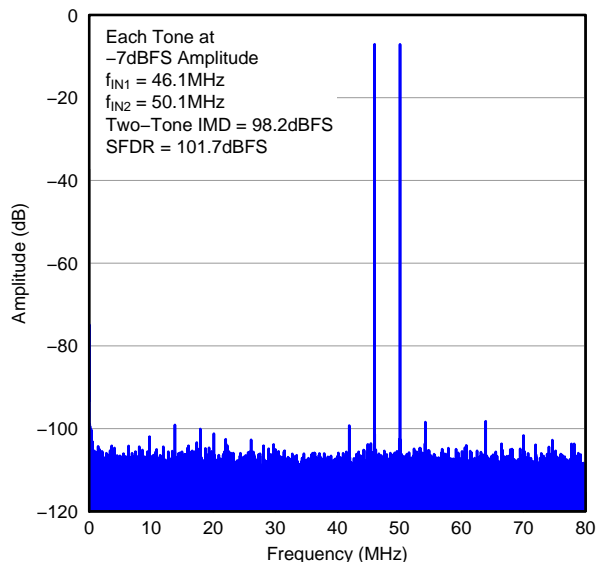

**Figure 85.**

**TYPICAL CHARACTERISTICS: ADS4226 (continued)**

At  $T_A = +25^\circ\text{C}$ ,  $AVDD = 1.8\text{V}$ ,  $DRVDD = 1.8\text{V}$ , maximum rated sampling frequency, sine wave input clock,  $1.5\text{V}_{PP}$  differential clock amplitude, 50% clock duty cycle,  $-1\text{dBFS}$  differential analog input, High-Performance Mode disabled,  $0\text{dB}$  gain, DDR LVDS output interface, and 32k point FFT, unless otherwise noted.

**FFT FOR TWO-TONE INPUT SIGNAL**



**Figure 86.**

**SFDR vs INPUT FREQUENCY**

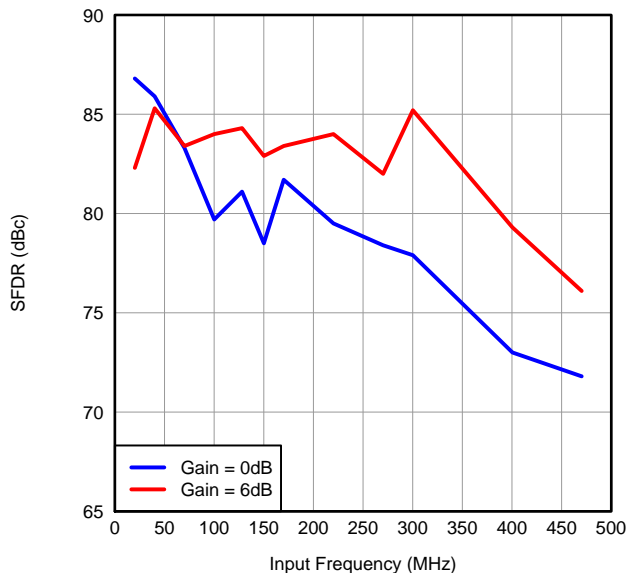

**Figure 87.**

**SNR vs INPUT FREQUENCY**

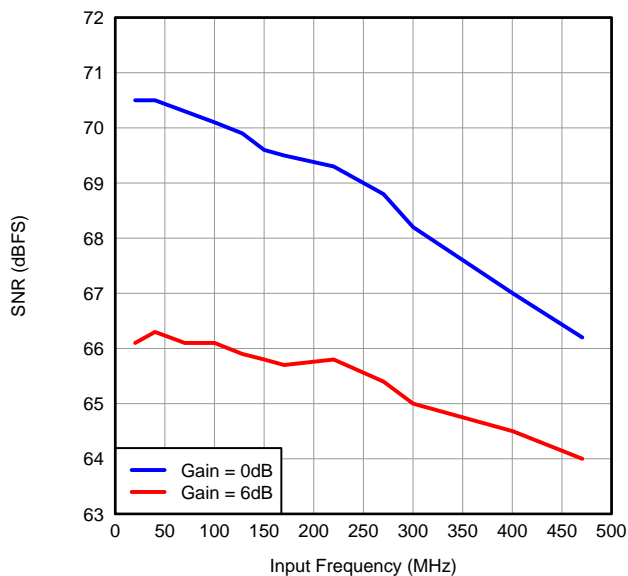

**Figure 88.**

**SNR vs INPUT FREQUENCY (CMOS)**

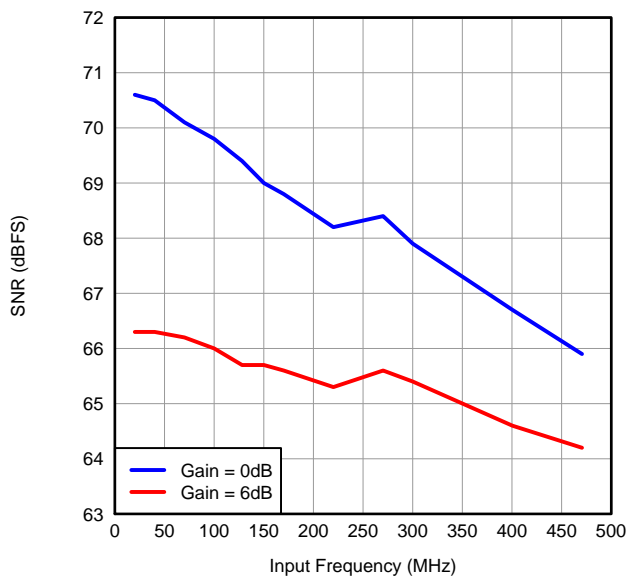

**Figure 89.**

**TYPICAL CHARACTERISTICS: ADS4226 (continued)**

At  $T_A = +25^\circ\text{C}$ ,  $AV_{DD} = 1.8\text{V}$ ,  $DRV_{DD} = 1.8\text{V}$ , maximum rated sampling frequency, sine wave input clock,  $1.5\text{V}_{PP}$  differential clock amplitude, 50% clock duty cycle,  $-1\text{dBFS}$  differential analog input, High-Performance Mode disabled,  $0\text{dB}$  gain, DDR LVDS output interface, and 32k point FFT, unless otherwise noted.

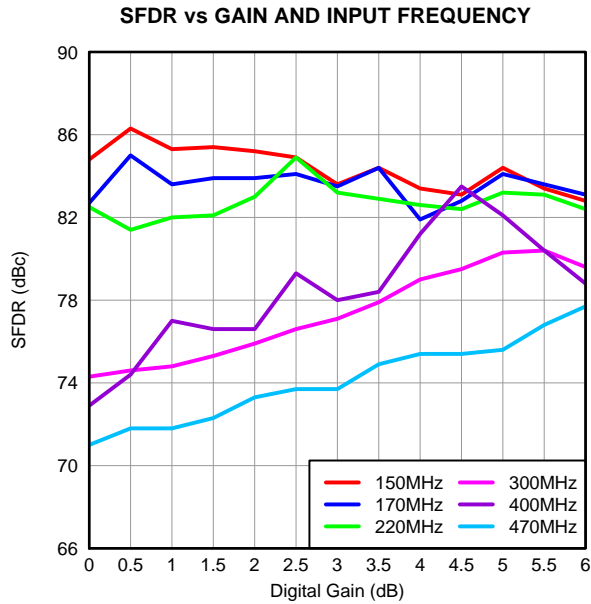

Figure 90.

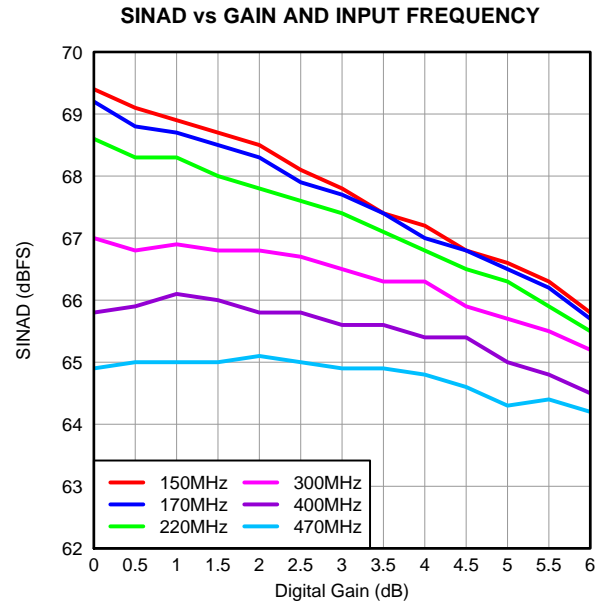

Figure 91.

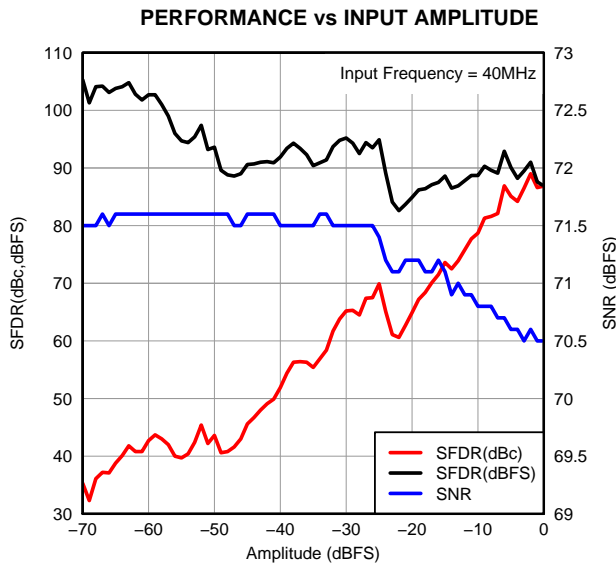

Figure 92.

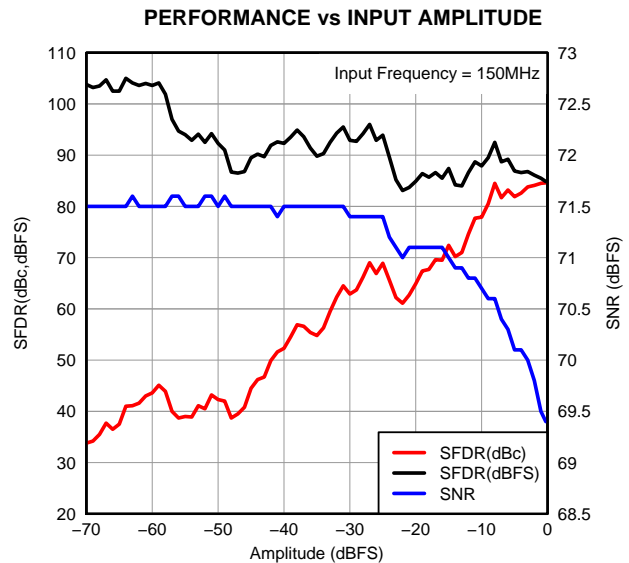

Figure 93.

**TYPICAL CHARACTERISTICS: ADS4226 (continued)**

At  $T_A = +25^\circ\text{C}$ ,  $AVDD = 1.8\text{V}$ ,  $DRVDD = 1.8\text{V}$ , maximum rated sampling frequency, sine wave input clock,  $1.5V_{PP}$  differential clock amplitude, 50% clock duty cycle,  $-1\text{dBFS}$  differential analog input, High-Performance Mode disabled, 0dB gain, DDR LVDS output interface, and 32k point FFT, unless otherwise noted.

**PERFORMANCE vs INPUT COMMON-MODE VOLTAGE**

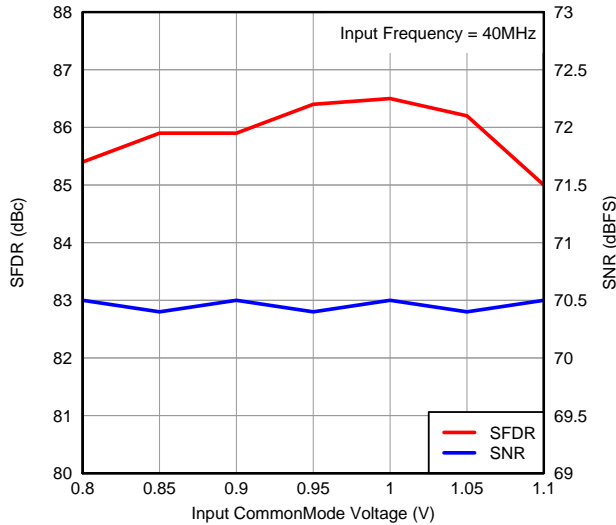

Figure 94.

**PERFORMANCE vs INPUT COMMON-MODE VOLTAGE**

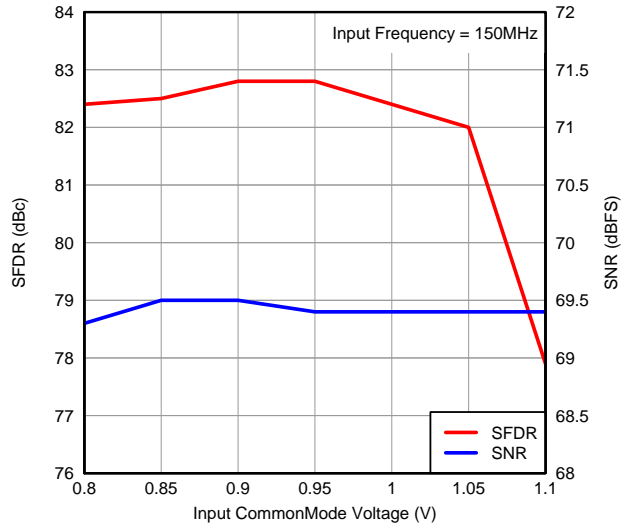

Figure 95.

**SFDR vs TEMPERATURE AND AVDD SUPPLY**

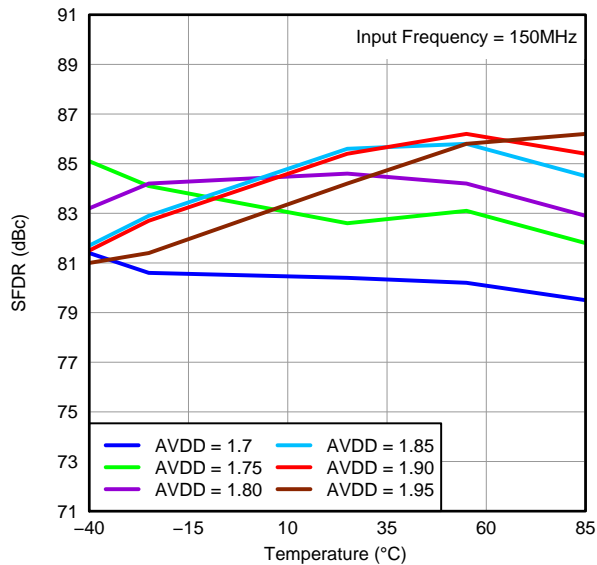

Figure 96.

**SNR vs TEMPERATURE AND AVDD SUPPLY**

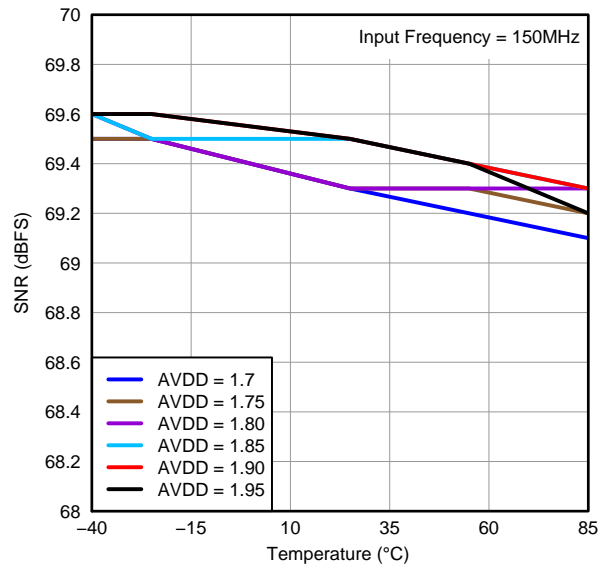

Figure 97.

**TYPICAL CHARACTERISTICS: ADS4226 (continued)**

At  $T_A = +25^\circ\text{C}$ ,  $AVDD = 1.8\text{V}$ ,  $DRVDD = 1.8\text{V}$ , maximum rated sampling frequency, sine wave input clock,  $1.5V_{PP}$  differential clock amplitude, 50% clock duty cycle,  $-1\text{dBFS}$  differential analog input, High-Performance Mode disabled, 0dB gain, DDR LVDS output interface, and 32k point FFT, unless otherwise noted.

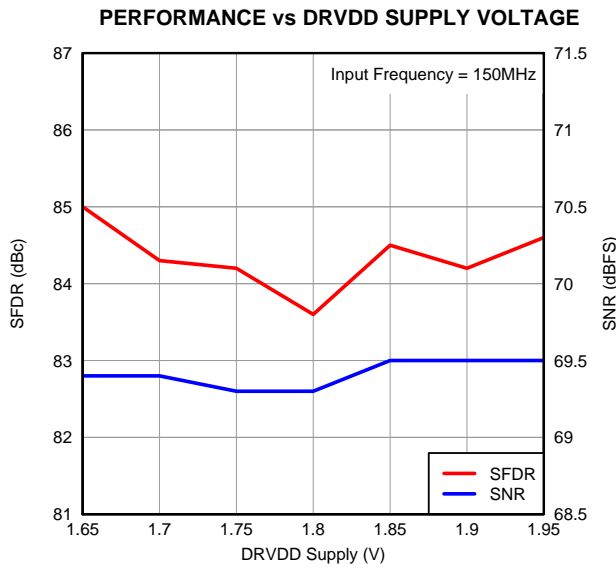

Figure 98.

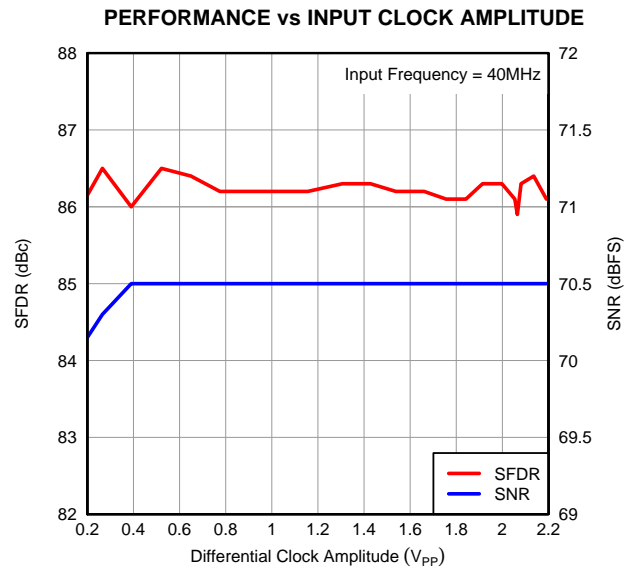

Figure 99.

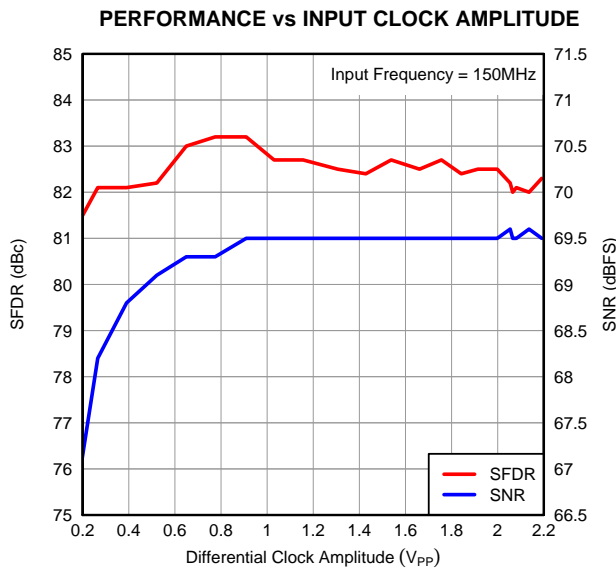

Figure 100.

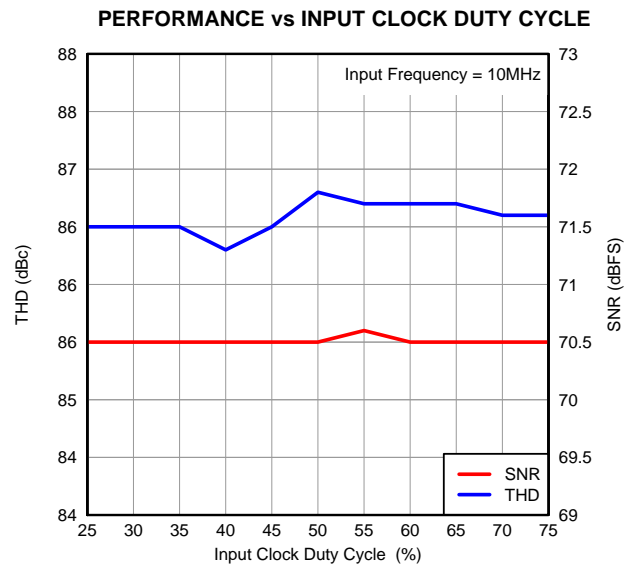
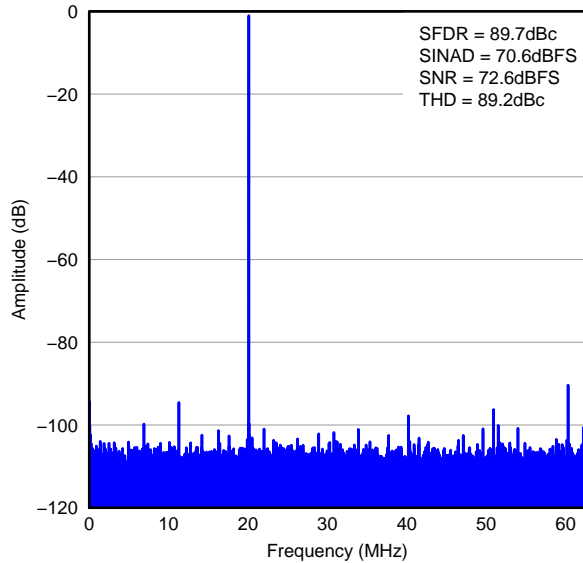

Figure 101.

**TYPICAL CHARACTERISTICS: ADS4225**

At  $T_A = +25^\circ\text{C}$ ,  $AVDD = 1.8\text{V}$ ,  $DRVDD = 1.8\text{V}$ , maximum rated sampling frequency, sine wave input clock,  $1.5\text{V}_{PP}$  differential clock amplitude, 50% clock duty cycle,  $-1\text{dBFS}$  differential analog input, High-Performance Mode disabled,  $0\text{dB}$  gain, DDR LVDS output interface, and 32k point FFT, unless otherwise noted.

**FFT FOR 20MHz INPUT SIGNAL**



**Figure 102.**

**FFT FOR 170MHz INPUT SIGNAL**

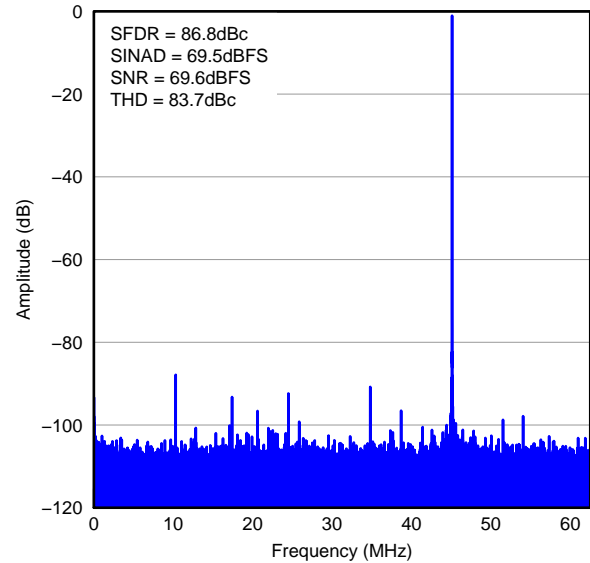

**Figure 103.**

**FFT FOR 300MHz INPUT SIGNAL**

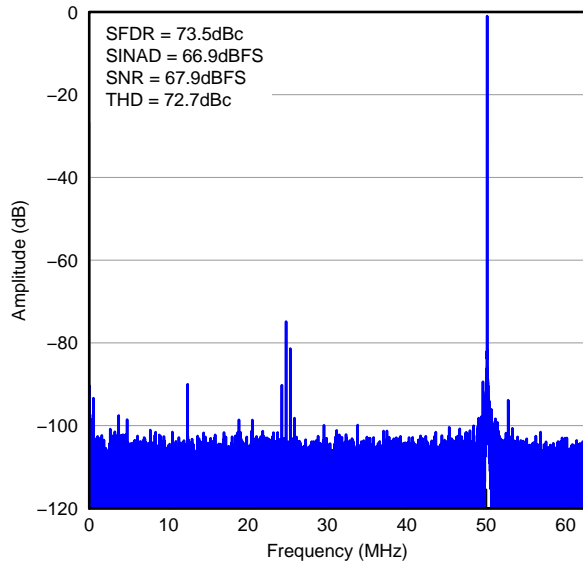

**Figure 104.**

**FFT FOR TWO-TONE INPUT SIGNAL**

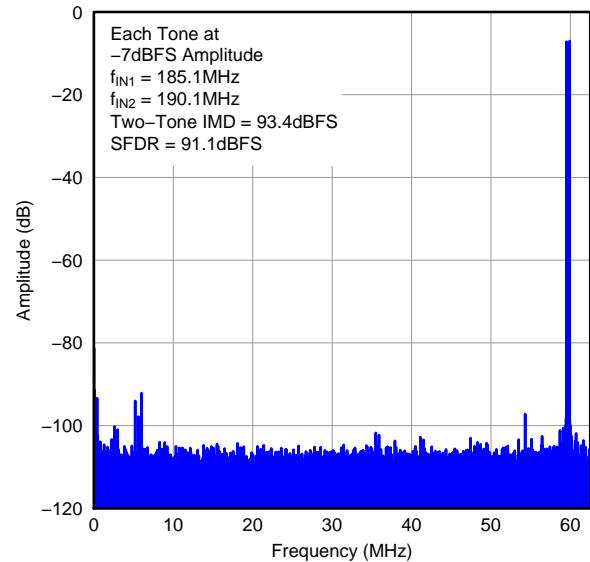
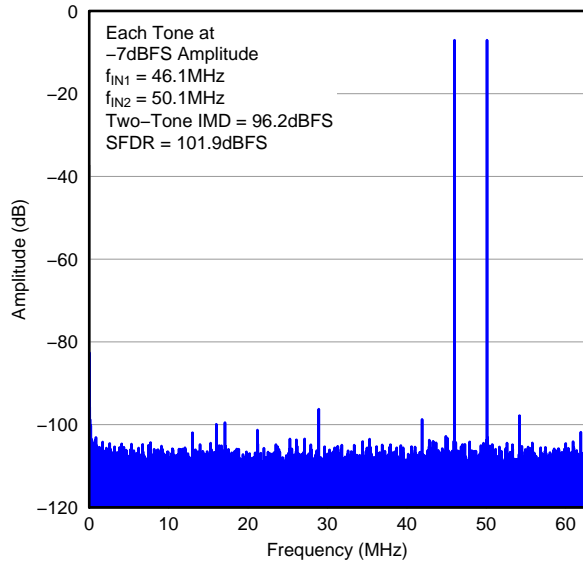

**Figure 105.**

**TYPICAL CHARACTERISTICS: ADS4225 (continued)**

At  $T_A = +25^\circ\text{C}$ ,  $AVDD = 1.8\text{V}$ ,  $DRVDD = 1.8\text{V}$ , maximum rated sampling frequency, sine wave input clock,  $1.5\text{V}_{PP}$  differential clock amplitude, 50% clock duty cycle,  $-1\text{dBFS}$  differential analog input, High-Performance Mode disabled,  $0\text{dB}$  gain, DDR LVDS output interface, and 32k point FFT, unless otherwise noted.

**FFT FOR TWO-TONE INPUT SIGNAL**



**Figure 106.**

**SFDR vs INPUT FREQUENCY**

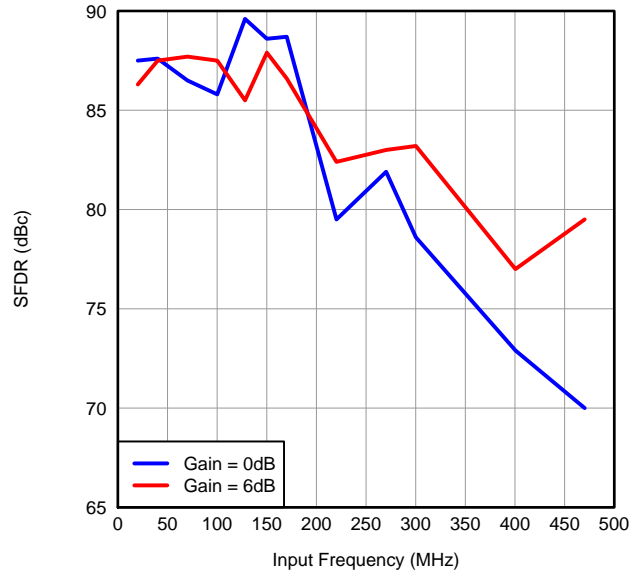

**Figure 107.**

**SNR vs INPUT FREQUENCY**

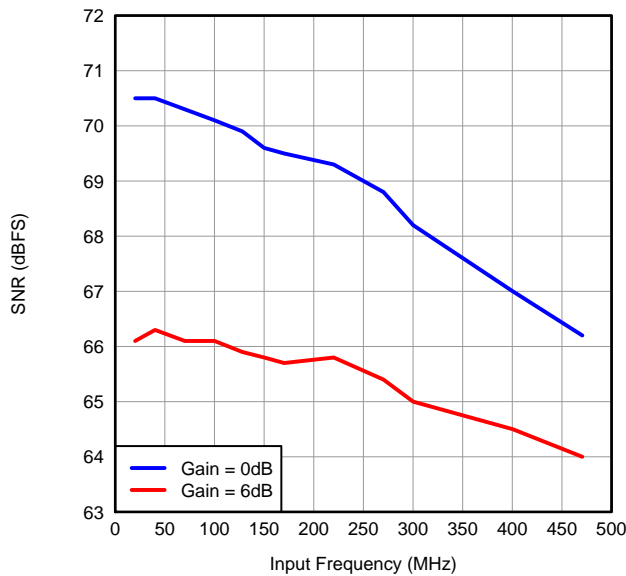

**Figure 108.**

**SNR vs INPUT FREQUENCY (CMOS)**

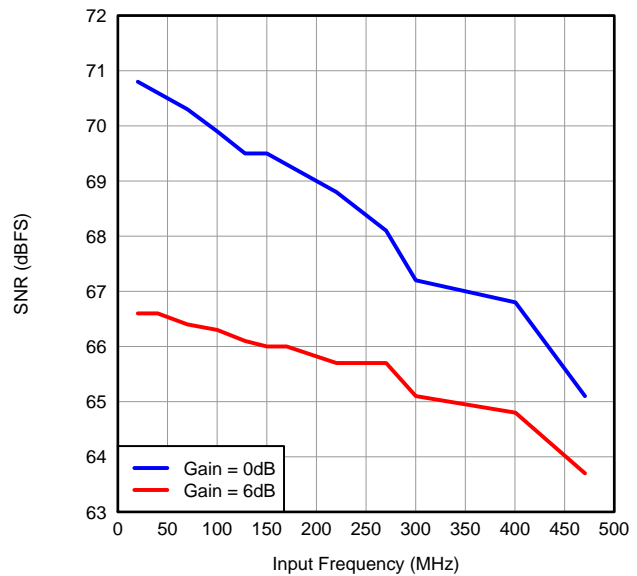

**Figure 109.**

**TYPICAL CHARACTERISTICS: ADS4225 (continued)**

At  $T_A = +25^{\circ}\text{C}$ ,  $AVDD = 1.8\text{V}$ ,  $DRVDD = 1.8\text{V}$ , maximum rated sampling frequency, sine wave input clock,  $1.5V_{PP}$  differential clock amplitude, 50% clock duty cycle,  $-1\text{dBFS}$  differential analog input, High-Performance Mode disabled,  $0\text{dB}$  gain, DDR LVDS output interface, and 32k point FFT, unless otherwise noted.

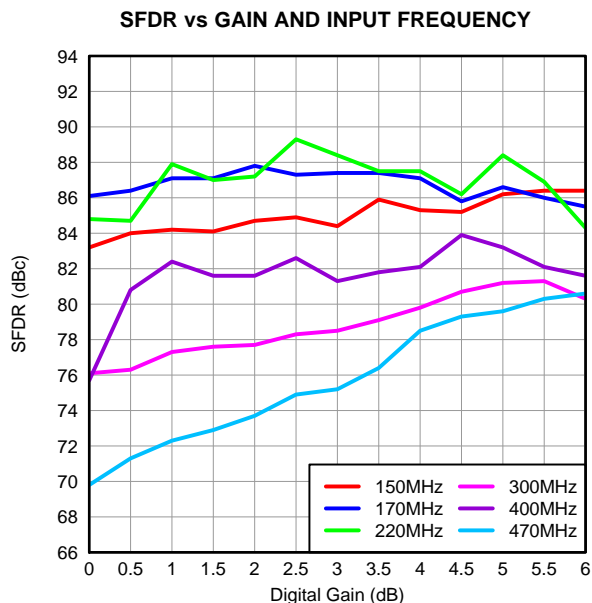

Figure 110.

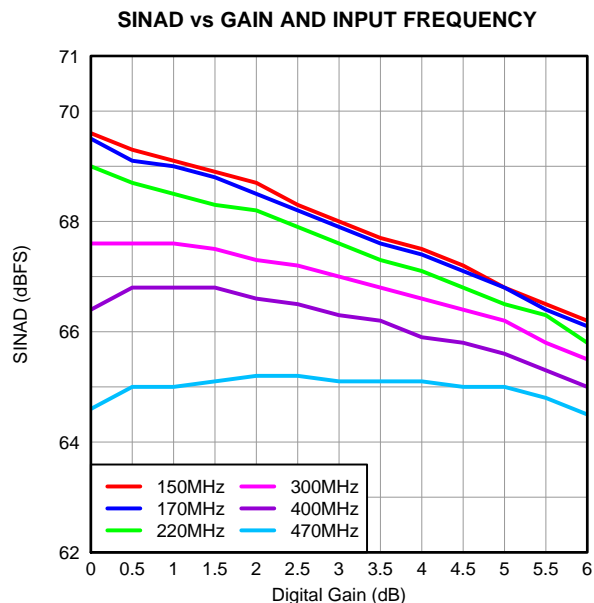

Figure 111.

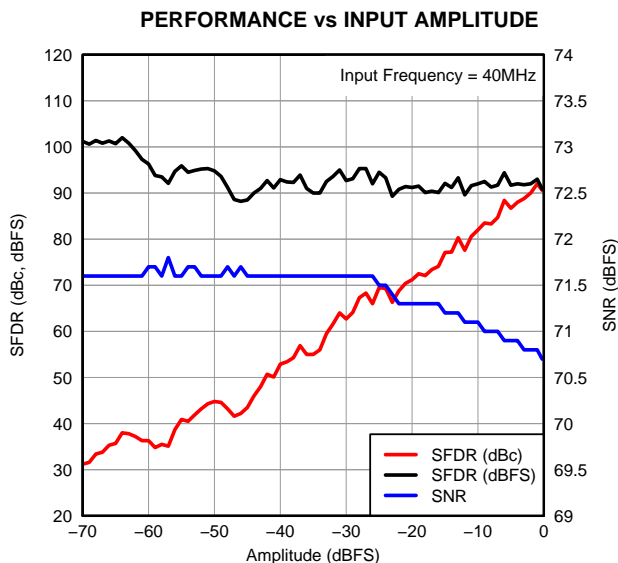

Figure 112.

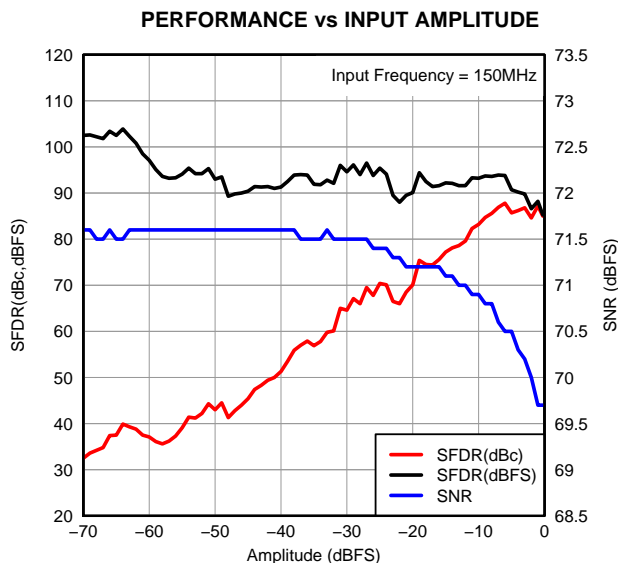

Figure 113.

**TYPICAL CHARACTERISTICS: ADS4225 (continued)**

At  $T_A = +25^\circ\text{C}$ ,  $AVDD = 1.8\text{V}$ ,  $DRVDD = 1.8\text{V}$ , maximum rated sampling frequency, sine wave input clock,  $1.5V_{PP}$  differential clock amplitude, 50% clock duty cycle,  $-1\text{dBFS}$  differential analog input, High-Performance Mode disabled, 0dB gain, DDR LVDS output interface, and 32k point FFT, unless otherwise noted.

**PERFORMANCE vs INPUT COMMON-MODE VOLTAGE**

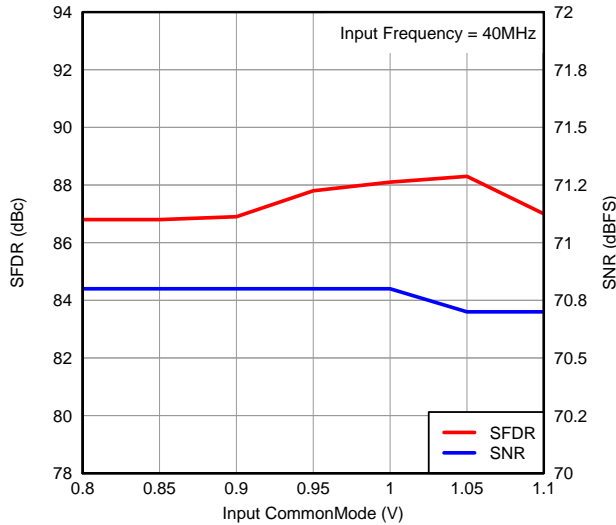

Figure 114.

**PERFORMANCE vs INPUT COMMON-MODE VOLTAGE**

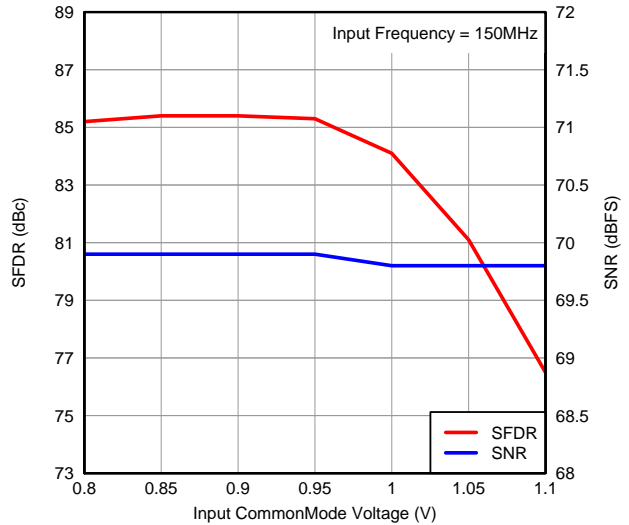

Figure 115.

**SFDR vs TEMPERATURE AND AVDD SUPPLY**

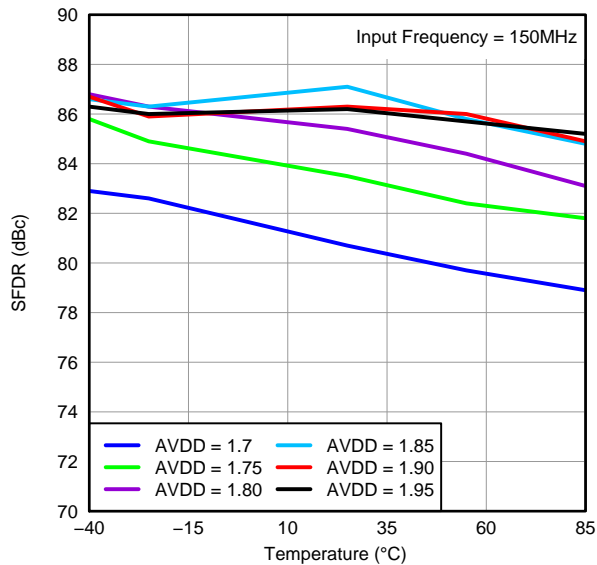

Figure 116.

**SNR vs TEMPERATURE AND AVDD SUPPLY**

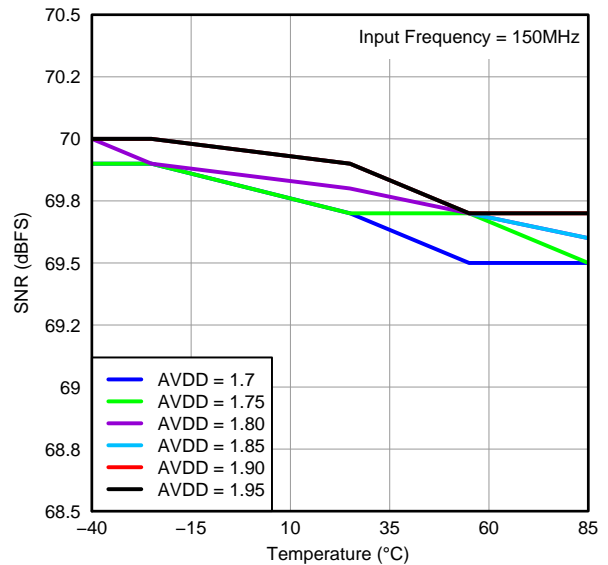

Figure 117.

**TYPICAL CHARACTERISTICS: ADS4225 (continued)**

At  $T_A = +25^\circ\text{C}$ ,  $AVDD = 1.8\text{V}$ ,  $DRVDD = 1.8\text{V}$ , maximum rated sampling frequency, sine wave input clock,  $1.5V_{PP}$  differential clock amplitude, 50% clock duty cycle,  $-1\text{dBFS}$  differential analog input, High-Performance Mode disabled,  $0\text{dB}$  gain, DDR LVDS output interface, and 32k point FFT, unless otherwise noted.

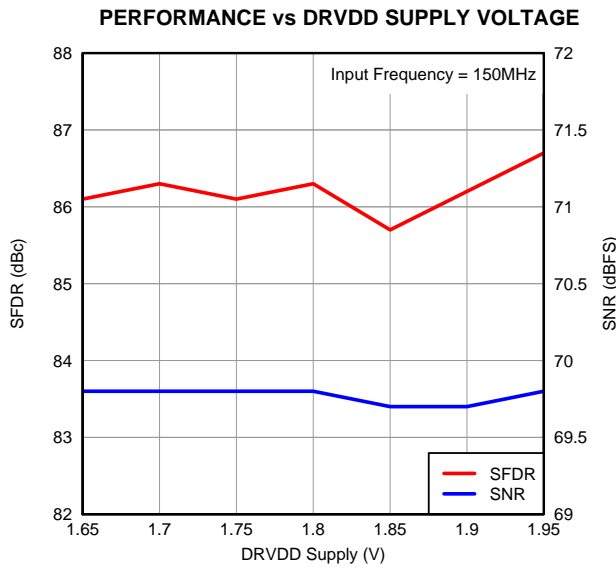

Figure 118.

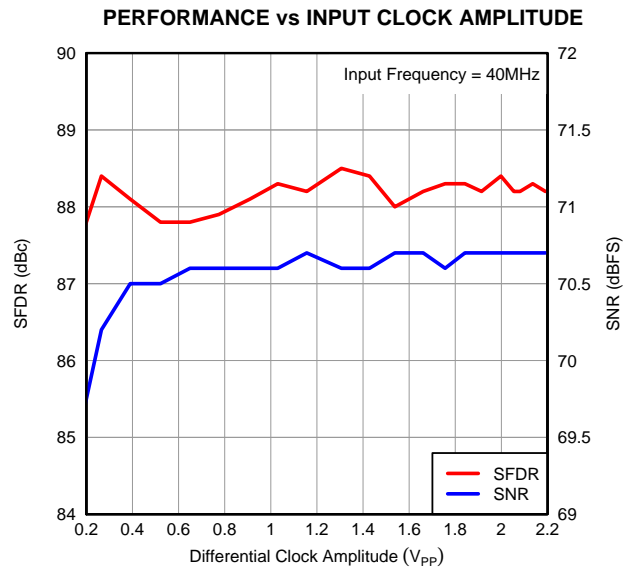

Figure 119.

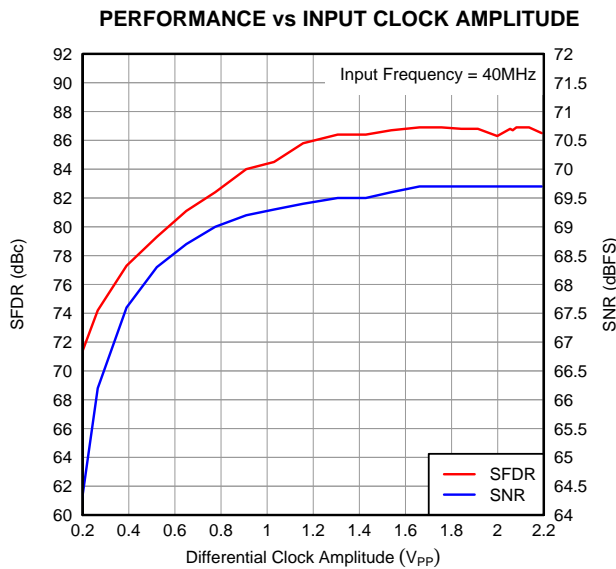

Figure 120.

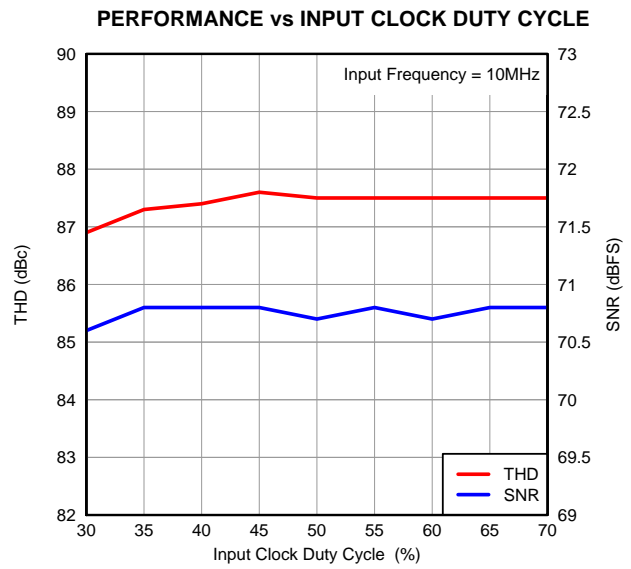
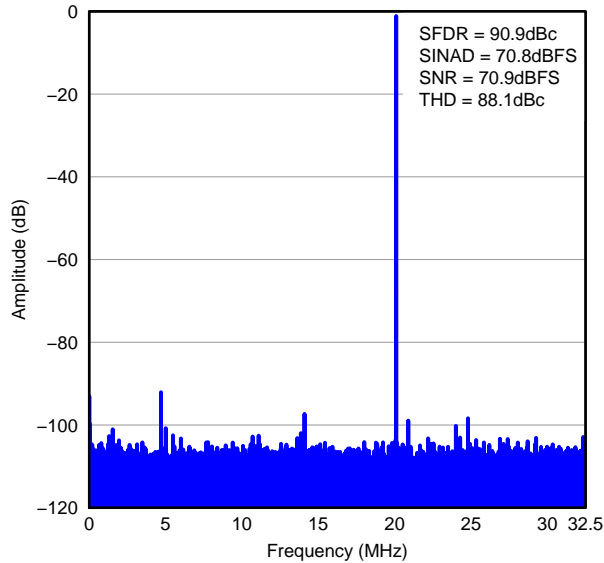

Figure 121.

**TYPICAL CHARACTERISTICS: ADS4222**

At  $T_A = +25^\circ\text{C}$ ,  $AV_{DD} = 1.8\text{V}$ ,  $DRV_{DD} = 1.8\text{V}$ , maximum rated sampling frequency, sine wave input clock,  $1.5\text{V}_{PP}$  differential clock amplitude, 50% clock duty cycle,  $-1\text{dBFS}$  differential analog input, High-Performance Mode disabled,  $0\text{dB}$  gain, DDR LVDS output interface, and 32k point FFT, unless otherwise noted.

**FFT FOR 20MHz INPUT SIGNAL**



**Figure 122.**

**FFT FOR 170MHz INPUT SIGNAL**

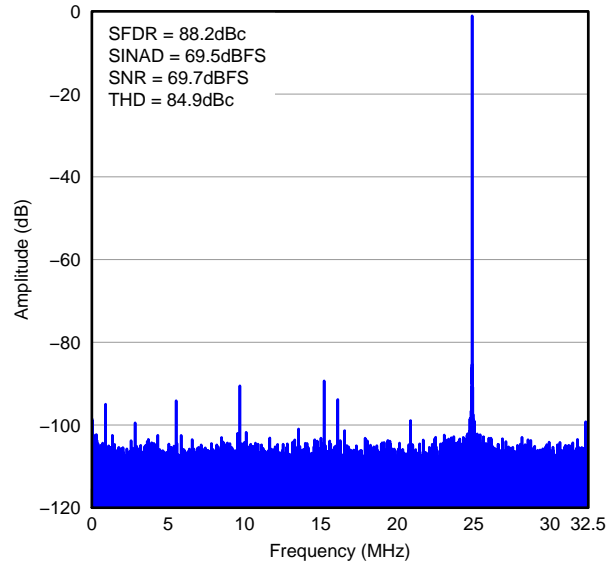

**Figure 123.**

**FFT FOR 300MHz INPUT SIGNAL**

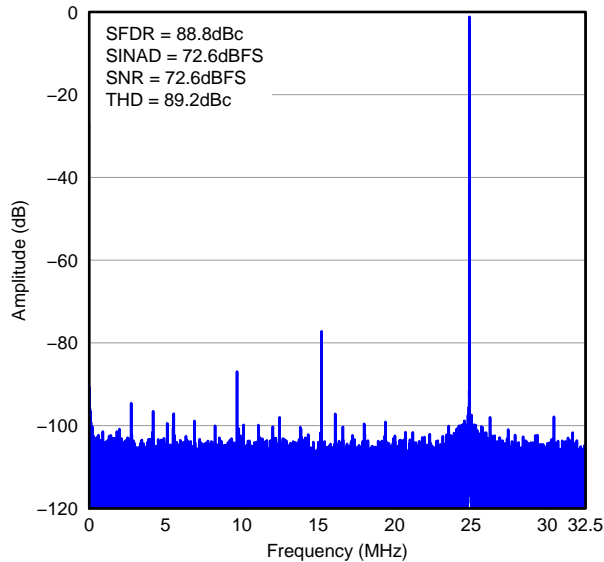

**Figure 124.**

**FFT FOR TWO-TONE INPUT SIGNAL**

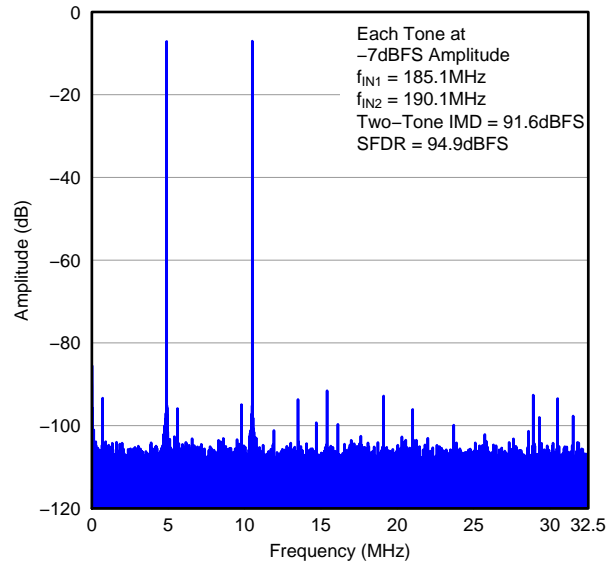
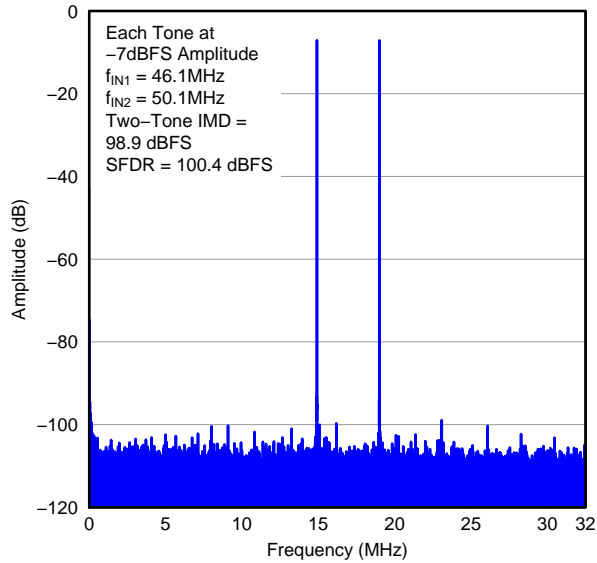

**Figure 125.**

**TYPICAL CHARACTERISTICS: ADS4222 (continued)**

At  $T_A = +25^\circ\text{C}$ ,  $AVDD = 1.8\text{V}$ ,  $DRVDD = 1.8\text{V}$ , maximum rated sampling frequency, sine wave input clock,  $1.5\text{V}_{PP}$  differential clock amplitude, 50% clock duty cycle,  $-1\text{dBFS}$  differential analog input, High-Performance Mode disabled,  $0\text{dB}$  gain, DDR LVDS output interface, and 32k point FFT, unless otherwise noted.

**FFT FOR TWO-TONE INPUT SIGNAL**



**Figure 126.**

**SFDR vs INPUT FREQUENCY**

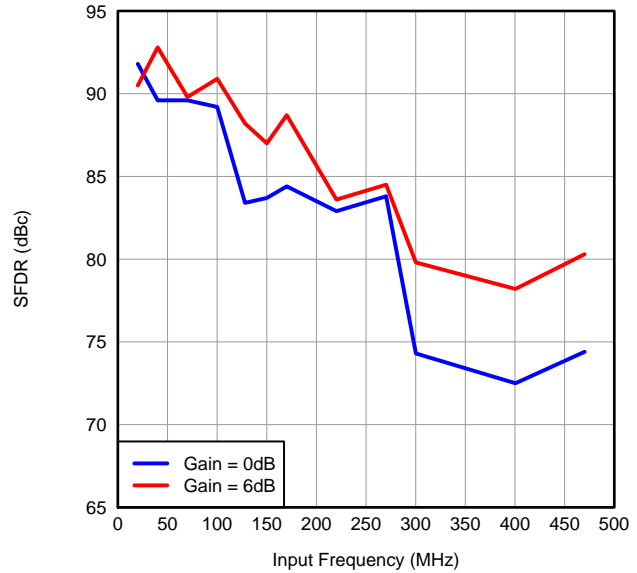

**Figure 127.**

**SNR vs INPUT FREQUENCY**

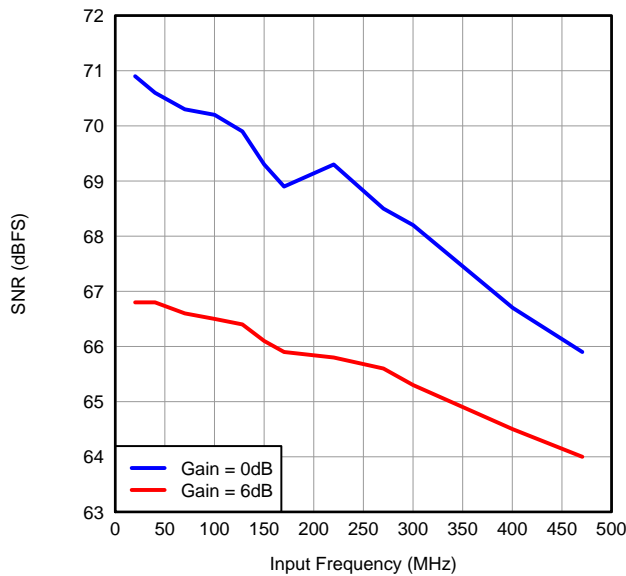

**Figure 128.**

**SNR vs INPUT FREQUENCY (CMOS)**

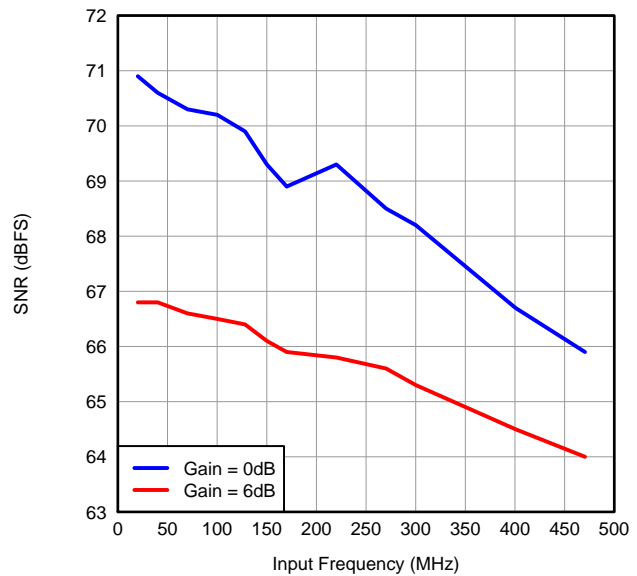

**Figure 129.**

**TYPICAL CHARACTERISTICS: ADS4222 (continued)**

At  $T_A = +25^{\circ}\text{C}$ ,  $AVDD = 1.8\text{V}$ ,  $DRVDD = 1.8\text{V}$ , maximum rated sampling frequency, sine wave input clock,  $1.5\text{V}_{PP}$  differential clock amplitude, 50% clock duty cycle,  $-1\text{dBFS}$  differential analog input, High-Performance Mode disabled,  $0\text{dB}$  gain, DDR LVDS output interface, and 32k point FFT, unless otherwise noted.

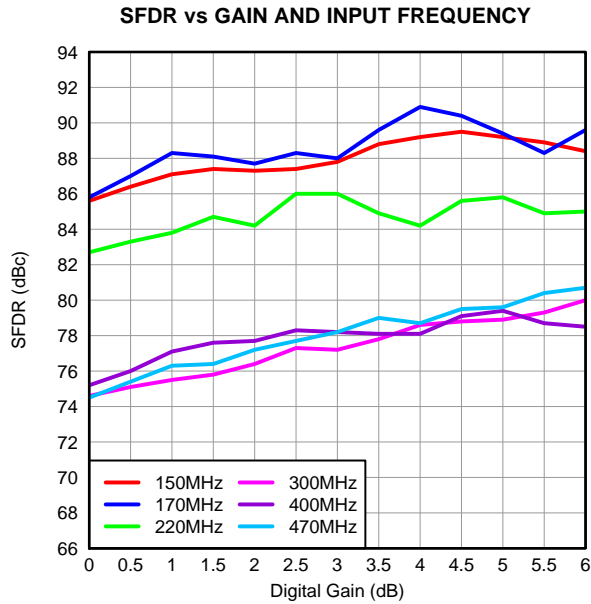

Figure 130.

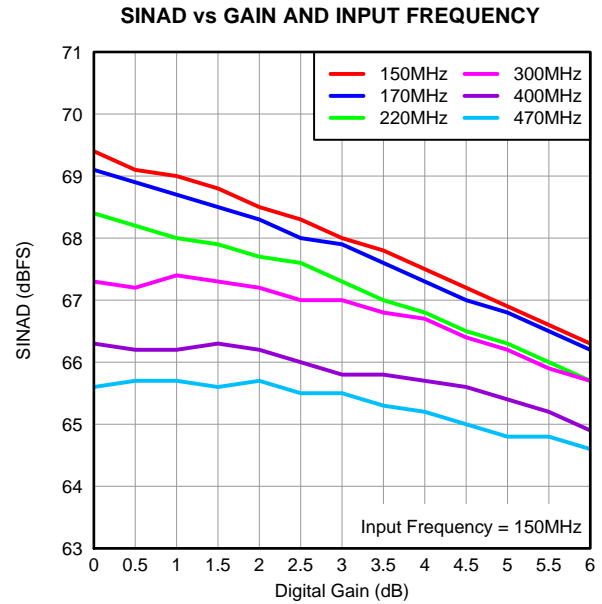

Figure 131.

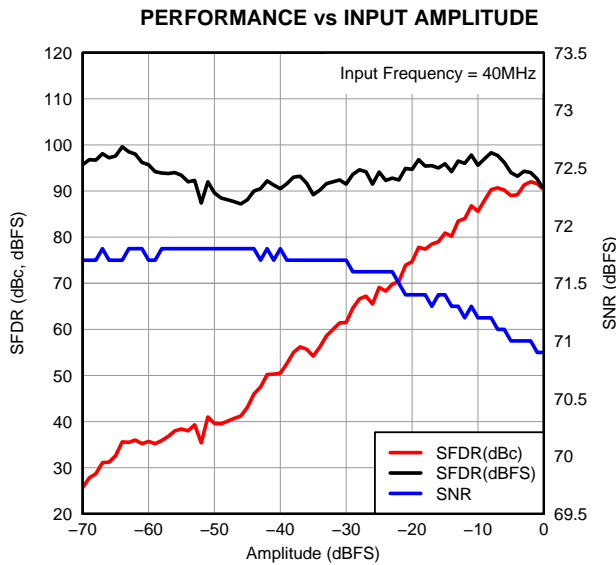

Figure 132.

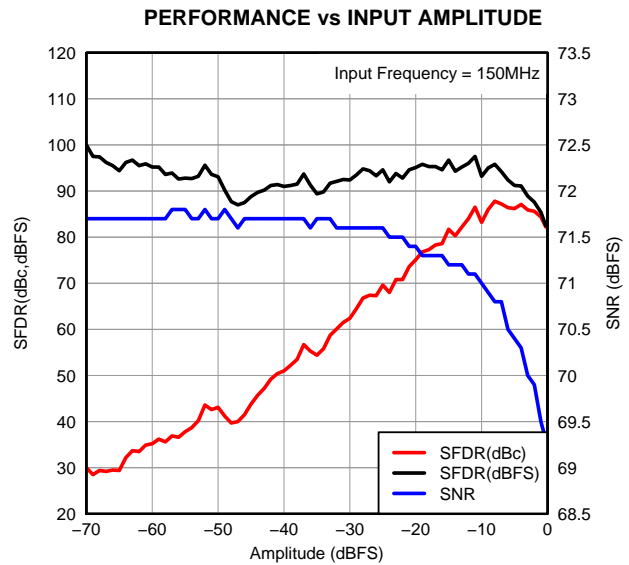
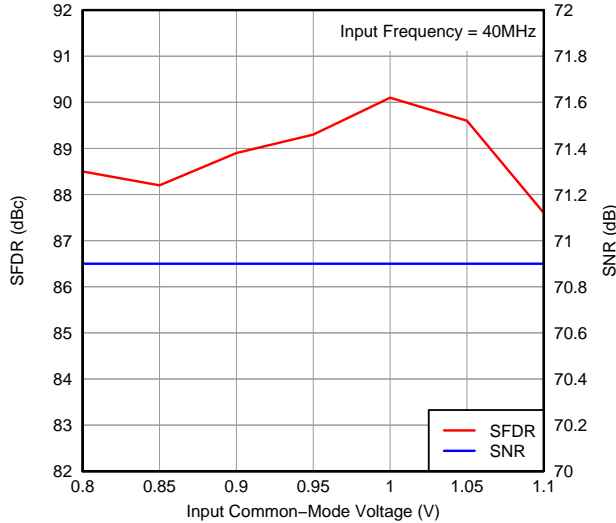

Figure 133.

**TYPICAL CHARACTERISTICS: ADS4222 (continued)**

At  $T_A = +25^\circ\text{C}$ ,  $AVDD = 1.8\text{V}$ ,  $DRVDD = 1.8\text{V}$ , maximum rated sampling frequency, sine wave input clock,  $1.5V_{PP}$  differential clock amplitude, 50% clock duty cycle,  $-1\text{dBFS}$  differential analog input, High-Performance Mode disabled, 0dB gain, DDR LVDS output interface, and 32k point FFT, unless otherwise noted.

**PERFORMANCE vs INPUT COMMON-MODE VOLTAGE**



**Figure 134.**

**PERFORMANCE vs INPUT COMMON-MODE VOLTAGE**

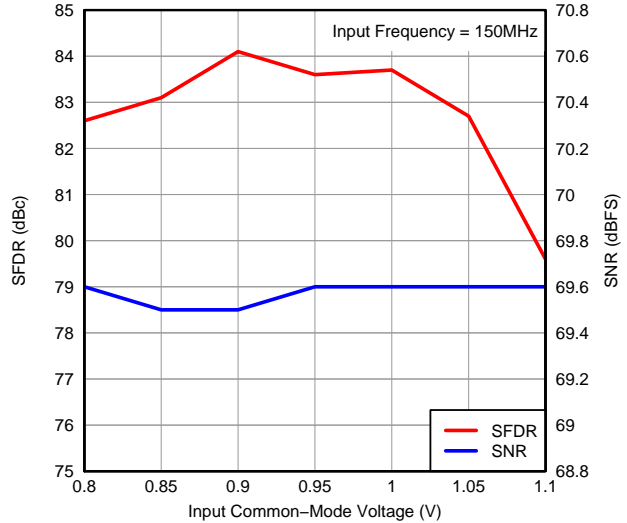

**Figure 135.**

**SFDR vs TEMPERATURE AND AVDD SUPPLY**

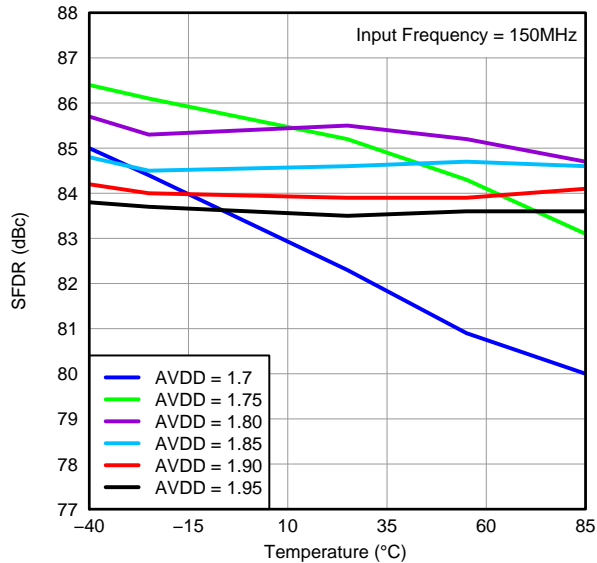

**Figure 136.**

**SNR vs TEMPERATURE AND AVDD SUPPLY**

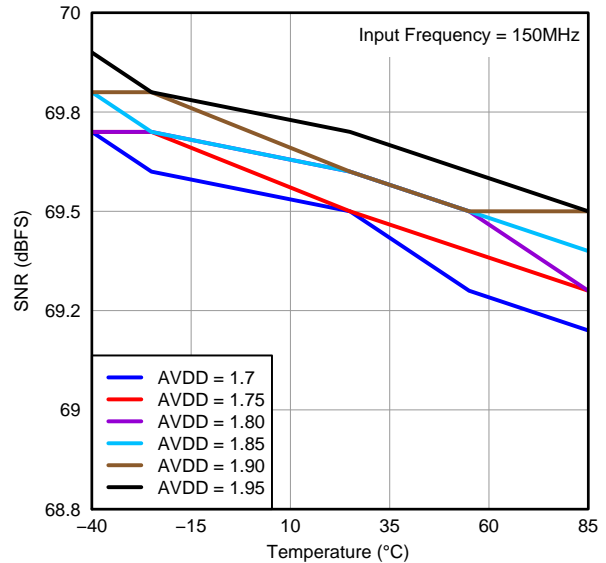

**Figure 137.**

**TYPICAL CHARACTERISTICS: ADS4222 (continued)**

At  $T_A = +25^\circ\text{C}$ ,  $AVDD = 1.8\text{V}$ ,  $DRVDD = 1.8\text{V}$ , maximum rated sampling frequency, sine wave input clock,  $1.5V_{PP}$  differential clock amplitude, 50% clock duty cycle,  $-1\text{dBFS}$  differential analog input, High-Performance Mode disabled,  $0\text{dB}$  gain, DDR LVDS output interface, and 32k point FFT, unless otherwise noted.

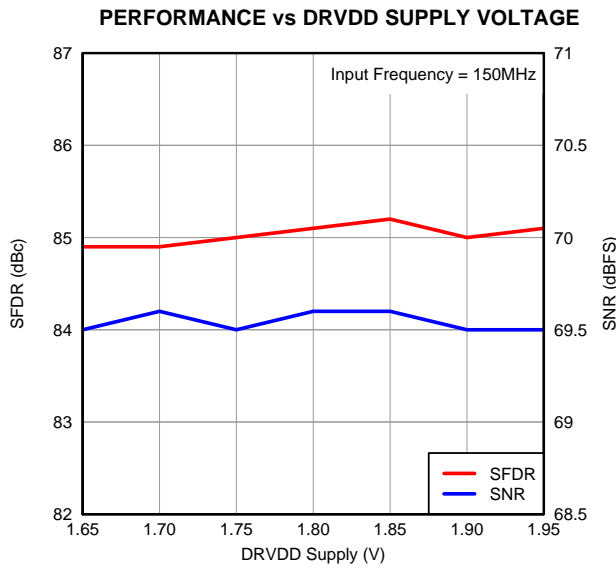

Figure 138.

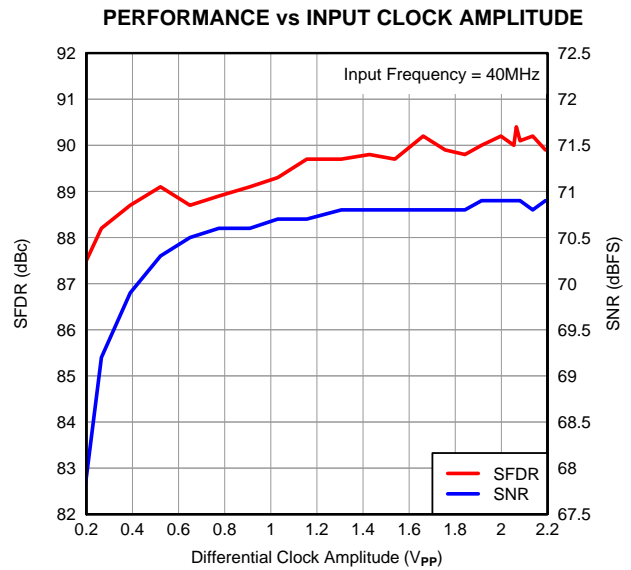

Figure 139.

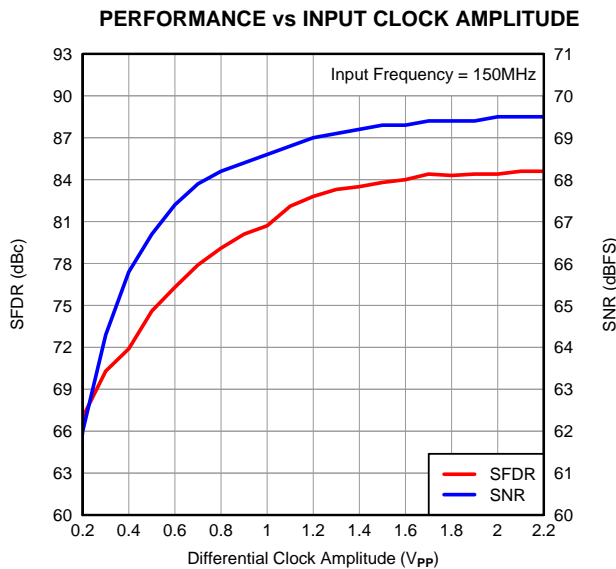

Figure 140.

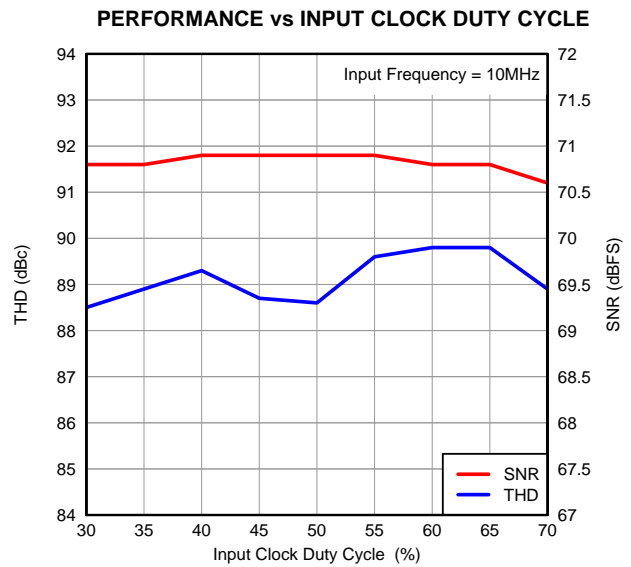

Figure 141.

**TYPICAL CHARACTERISTICS: General**

At  $T_A = +25^\circ\text{C}$ ,  $AVDD = 1.8\text{V}$ ,  $DRVDD = 1.8\text{V}$ , maximum rated sampling frequency, sine wave input clock,  $1.5\text{V}_{PP}$  differential clock amplitude, 50% clock duty cycle,  $-1\text{dBFS}$  differential analog input, High-Performance Mode disabled, 0dB gain, DDR LVDS output interface, and 32k point FFT, unless otherwise noted.

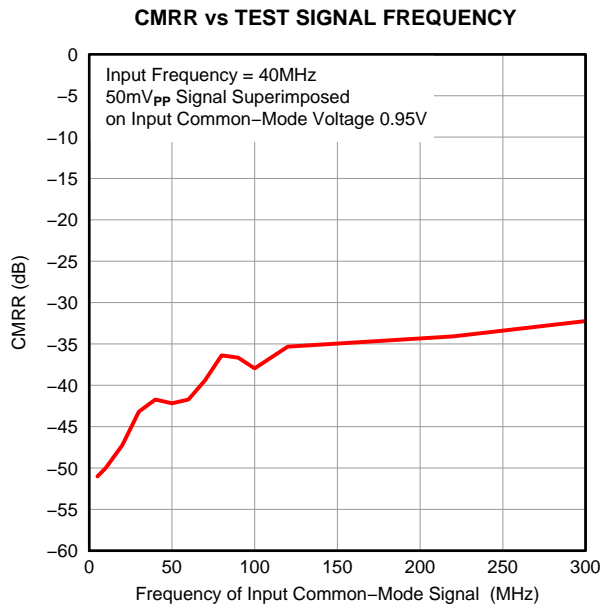

Figure 142.

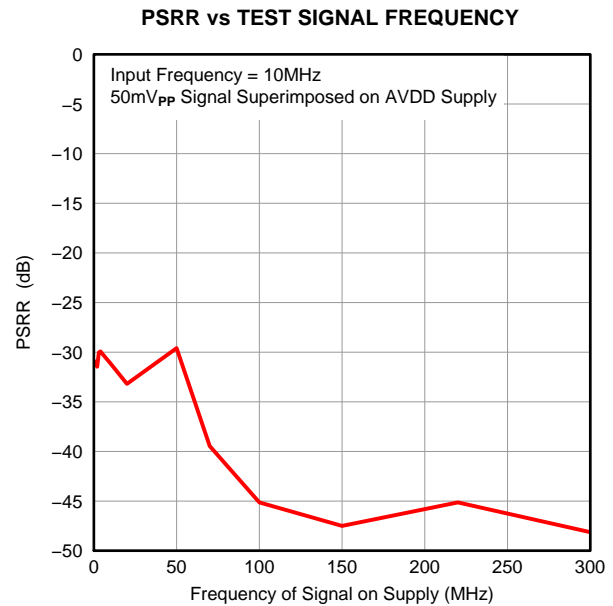

Figure 143.

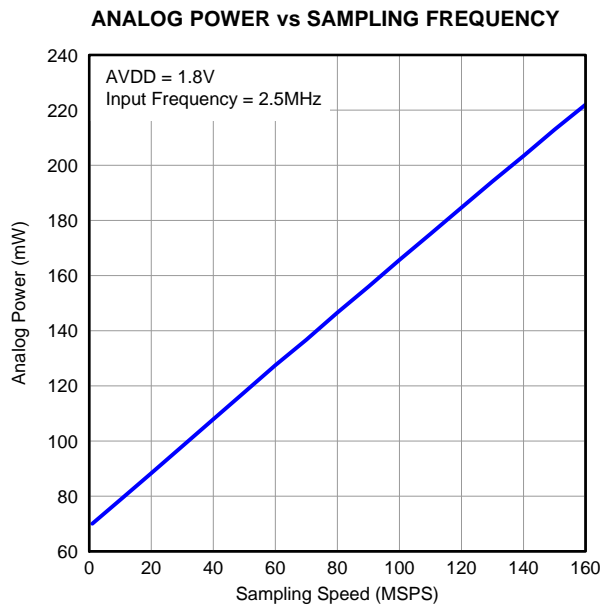

Figure 144.

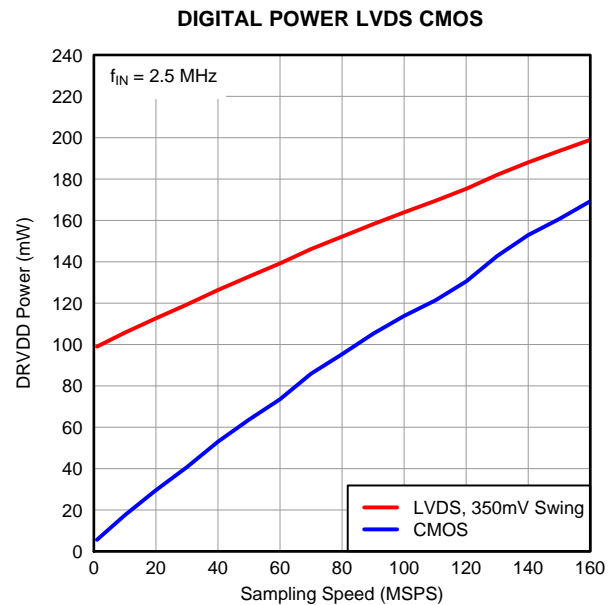
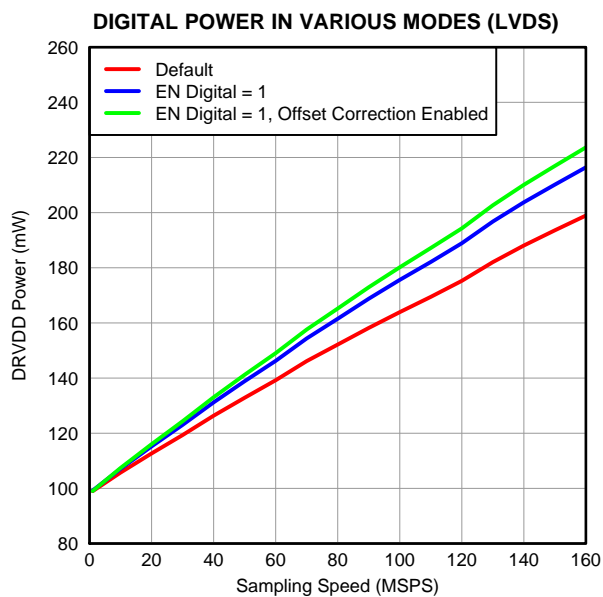

Figure 145.

**TYPICAL CHARACTERISTICS: General (continued)**

At  $T_A = +25^\circ\text{C}$ ,  $AVDD = 1.8\text{V}$ ,  $DRVDD = 1.8\text{V}$ , maximum rated sampling frequency, sine wave input clock,  $1.5V_{PP}$  differential clock amplitude, 50% clock duty cycle,  $-1\text{dBFS}$  differential analog input, High-Performance Mode disabled, 0dB gain, DDR LVDS output interface, and 32k point FFT, unless otherwise noted.



**Figure 146.**

**TYPICAL CHARACTERISTICS: Contour**

All graphs are at +25°C, AVDD = 1.8V, DRVDD = 1.8V, maximum rated sampling frequency, sine wave input clock. 1.5V<sub>PP</sub> differential clock amplitude, 50% clock duty cycle, -1dBFS differential analog input, High-Performance Mode disabled, 0dB gain, DDR LVDS output interface, and 32k point FFT, unless otherwise noted.

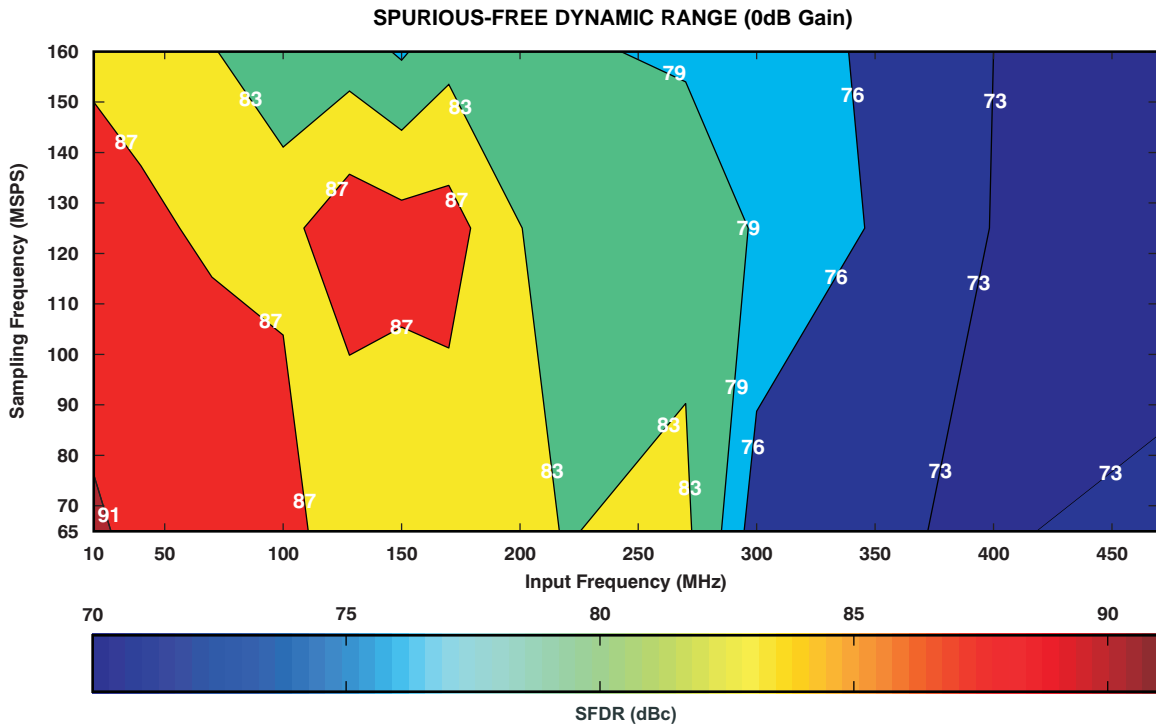

Figure 147.

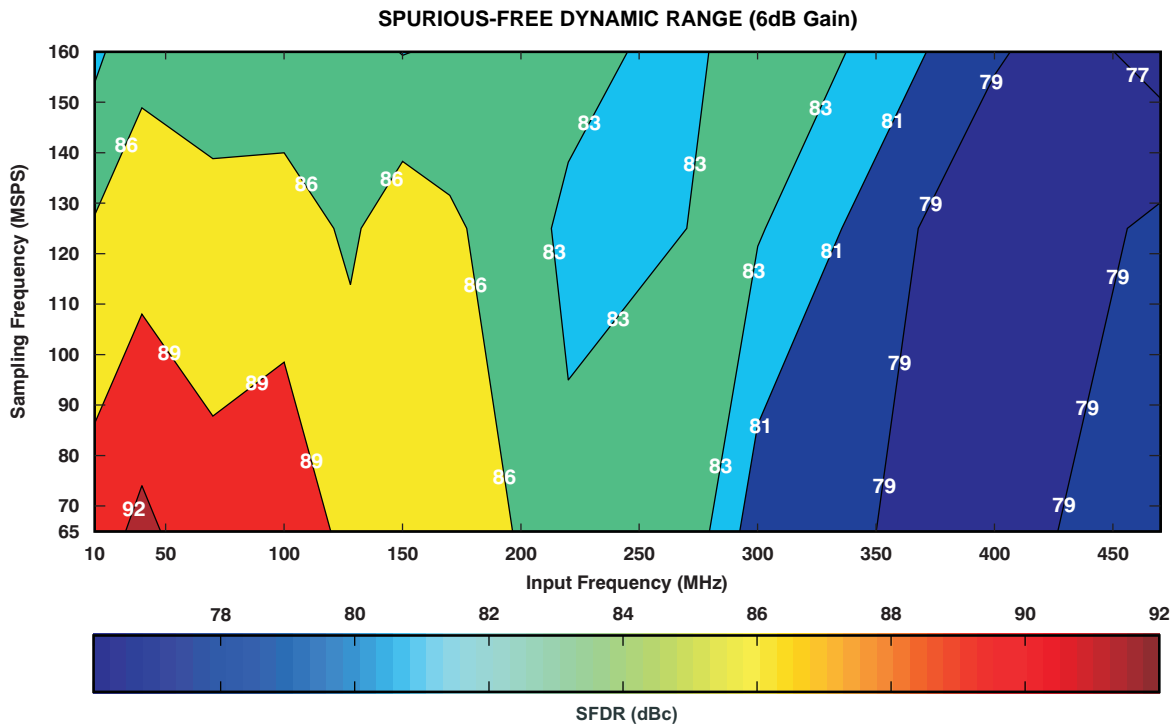

Figure 148.

**TYPICAL CHARACTERISTICS: Contour (continued)**

All graphs are at +25°C, AVDD = 1.8V, DRVDD = 1.8V, maximum rated sampling frequency, sine wave input clock. 1.5V<sub>PP</sub> differential clock amplitude, 50% clock duty cycle, -1dBFS differential analog input, High-Performance Mode disabled, 0dB gain, DDR LVDS output interface, and 32k point FFT, unless otherwise noted.

**ADS424x SIGNAL-TO-NOISE RATIO (0dB Gain)**

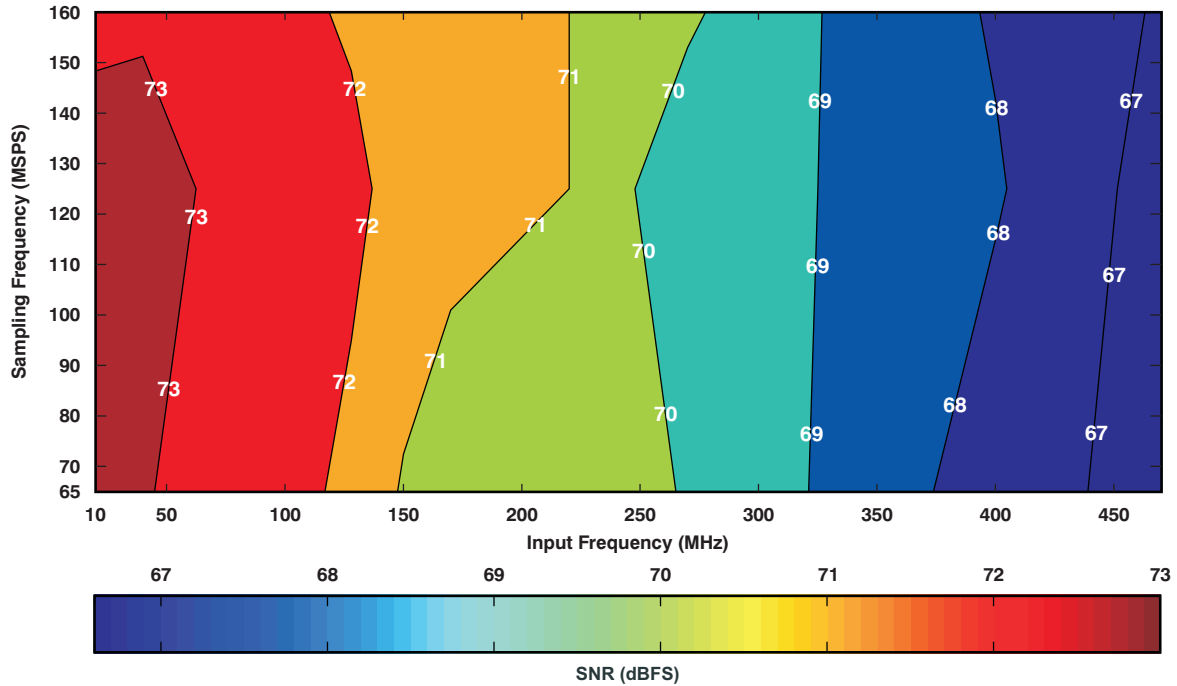

Figure 149.

**ADS424x SIGNAL-TO-NOISE RATIO (6dB Gain)**

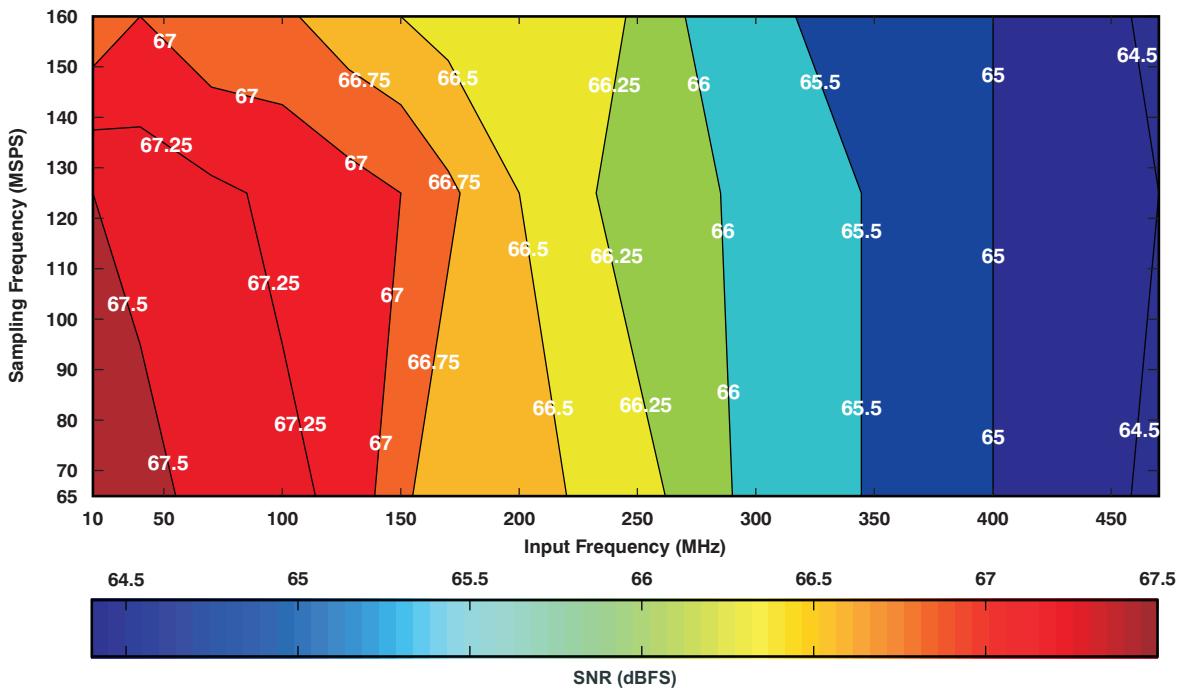

Figure 150.

**TYPICAL CHARACTERISTICS: Contour (continued)**

All graphs are at +25°C, AVDD = 1.8V, DRVDD = 1.8V, maximum rated sampling frequency, sine wave input clock. 1.5V<sub>PP</sub> differential clock amplitude, 50% clock duty cycle, -1dBFS differential analog input, High-Performance Mode disabled, 0dB gain, DDR LVDS output interface, and 32k point FFT, unless otherwise noted.

**ADS422x SIGNAL-TO-NOISE RATIO (0dB Gain)**

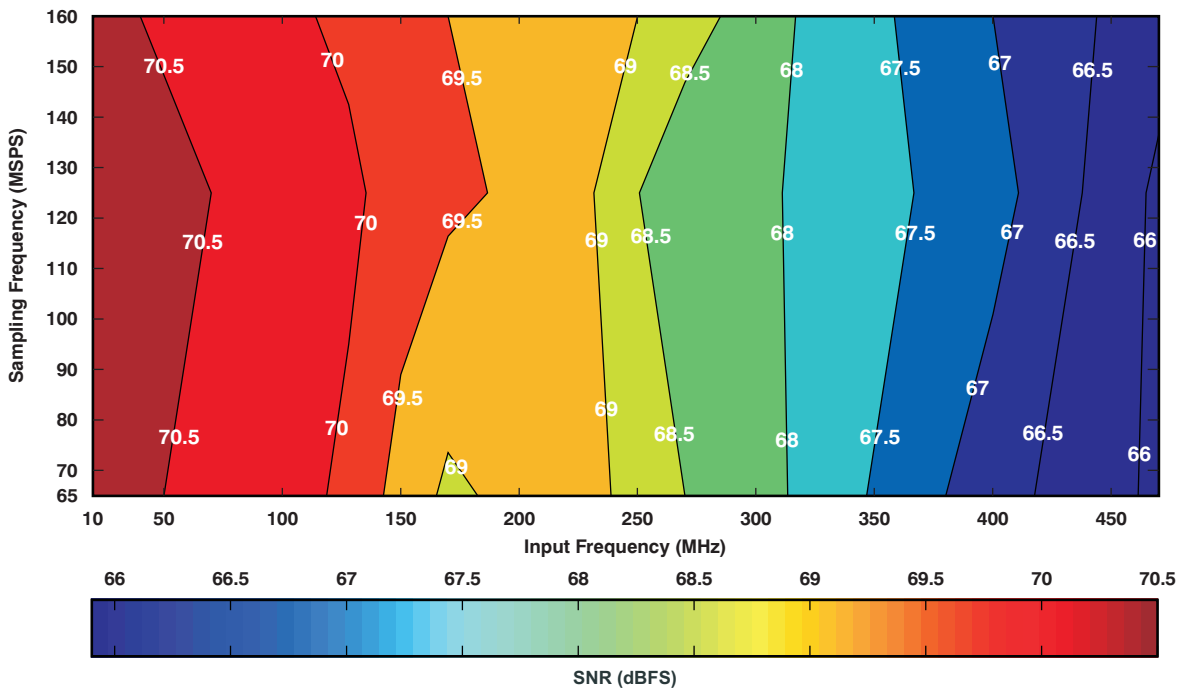

Figure 151.

**ADS422x SIGNAL-TO-NOISE RATIO (6dB Gain)**

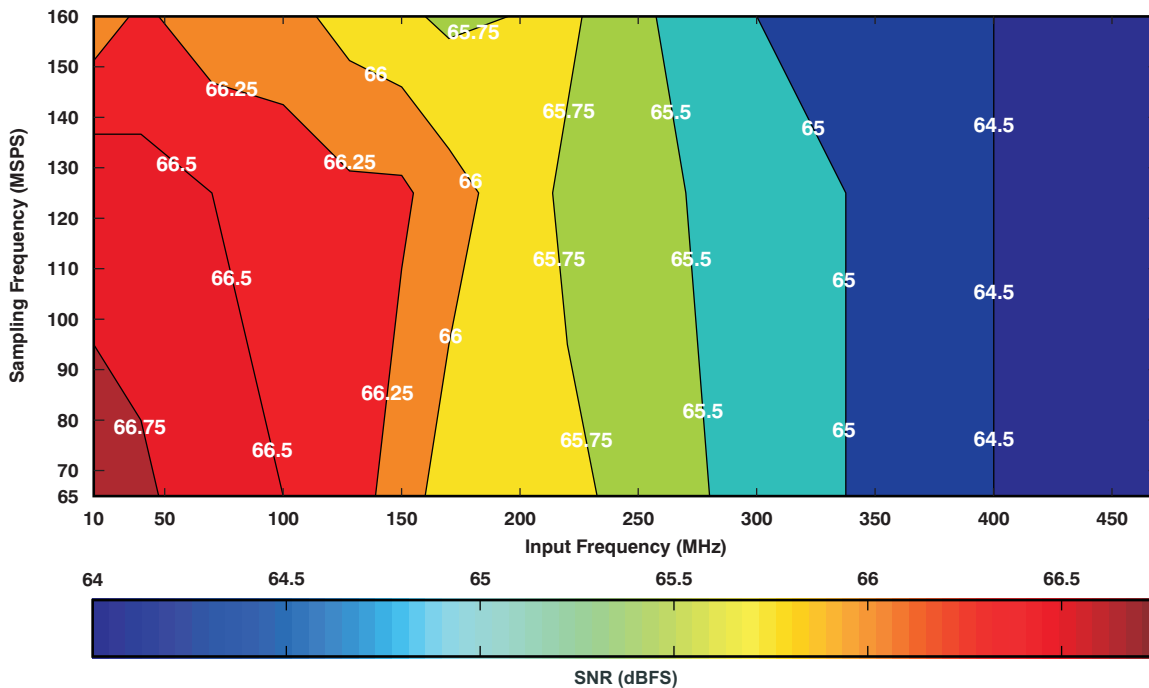

Figure 152.

## APPLICATION INFORMATION

### THEORY OF OPERATION

The ADS424x/422x belong to TI's ultralow-power family of dual-channel 12-bit and 14-bit analog-to-digital converters (ADCs). At every rising edge of the input clock, the analog input signal of each channel is simultaneously sampled. The sampled signal in each channel is converted by a pipeline of low-resolution stages. In each stage, the sampled/held signal is converted by a high-speed, low-resolution, flash sub-ADC. The difference between the stage input and the quantized equivalent is gained and propagates to the next stage. At every clock, each succeeding stage resolves the sampled input with greater accuracy. The digital outputs from all stages are combined in a digital correction logic block and digitally processed to create the final code after a data latency of 16 clock cycles. The digital output is available as either DDR LVDS or parallel CMOS and coded in either straight offset binary or binary twos complement format. The dynamic offset of the first stage sub-ADC limits the maximum analog input frequency to approximately 400MHz (with  $2V_{PP}$  amplitude) or approximately 600MHz (with  $1V_{PP}$  amplitude).

### ANALOG INPUT

The analog input consists of a switched-capacitor based, differential sample-and-hold (S/H) architecture. This differential topology results in very good ac performance even for high input frequencies at high sampling rates. The INP and INM pins must be externally biased around a common-mode voltage of 0.95V, available on the VCM pin. For a full-scale differential input, each input pin (INP and INM) must swing symmetrically between  $V_{CM} + 0.5V$  and  $V_{CM} - 0.5V$ , resulting in a  $2V_{PP}$  differential input swing. The input sampling circuit has a high 3dB bandwidth that extends up to 550MHz (measured from the input pins to the sampled voltage). [Figure 153](#) shows an equivalent circuit for the analog input.

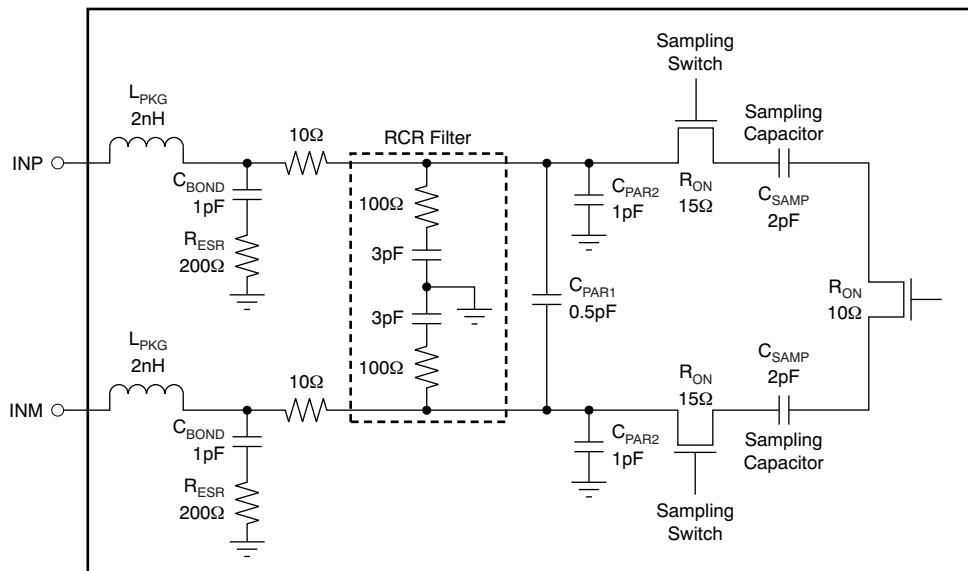

Figure 153. Analog Input Equivalent Circuit

## Drive Circuit Requirements

For optimum performance, the analog inputs must be driven differentially. This operation improves the common-mode noise immunity and even-order harmonic rejection. A 5Ω to 15Ω resistor in series with each input pin is recommended to damp out ringing caused by package parasitics.

SFDR performance can be limited as a result of several reasons, including the effects of sampling glitches; nonlinearity of the sampling circuit; and nonlinearity of the quantizer that follows the sampling circuit. Depending on the input frequency, sample rate, and input amplitude, one of these factors plays a dominant part in limiting performance. At very high input frequencies (greater than approximately 300MHz), SFDR is determined largely by the device sampling circuit nonlinearity. At low input amplitudes, the quantizer nonlinearity usually limits performance.

Glitches are caused by the opening and closing of the sampling switches. The driving circuit should present a low source impedance to absorb these glitches. Otherwise, glitches could limit performance, primarily at low input frequencies (up to approximately 200MHz). It is also necessary to present low impedance (less than 50Ω) for the common-mode switching currents. This configuration can be achieved by using two resistors from each input terminated to the common-mode voltage (VCM).

The device includes an internal R-C filter from each input to ground. The purpose of this filter is to absorb the sampling glitches inside the device itself. The cutoff frequency of the R-C filter involves a trade-off. A lower cutoff frequency (larger C) absorbs glitches better, but it reduces the input bandwidth. On the other hand, with a higher cutoff frequency (smaller C), bandwidth support is maximized. However, the sampling glitches now must be supplied by the external drive circuit. This tradeoff has limitations as a result of the presence of the package bond-wire inductance.

In the ADS424x/422x, the R-C component values have been optimized while supporting high input bandwidth (up to 550MHz). However, in applications with input frequencies up to 200MHz to 300MHz, the filtering of the glitches can be improved further using an external R-C-R filter; see [Figure 156](#) and [Figure 157](#).

In addition, the drive circuit may have to be designed to provide a low insertion loss over the desired frequency range and matched impedance to the source. Furthermore, the ADC input impedance must be considered. [Figure 154](#) and [Figure 155](#) show the impedance ( $Z_{IN} = R_{IN} \parallel C_{IN}$ ) looking into the ADC input pins.

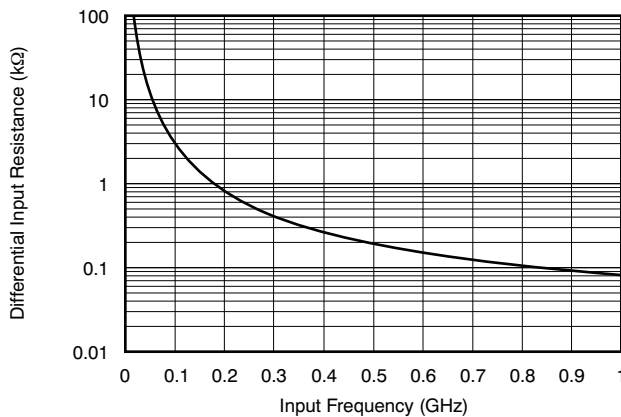

**Figure 154. ADC Analog Input Resistance ( $R_{IN}$ ) Across Frequency**

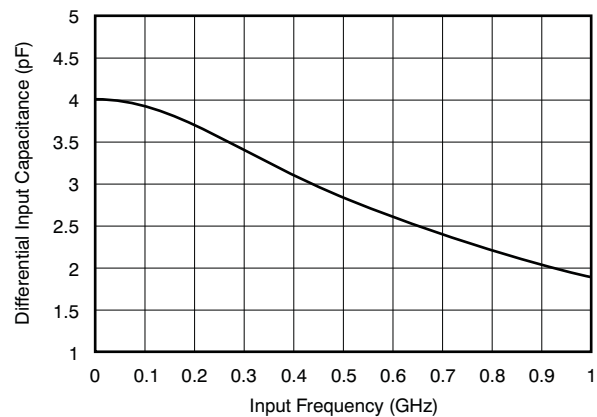
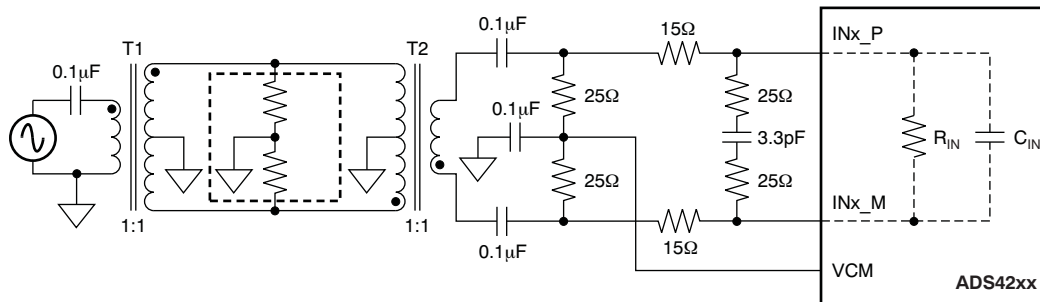

**Figure 155. ADC Analog Input Capacitance ( $C_{IN}$ ) Across Frequency**

## Driving Circuit

Two example driving circuit configurations are shown in [Figure 156](#) and [Figure 157](#)—one optimized for low bandwidth (low input frequencies) and the other one for high bandwidth to support higher input frequencies. Note that both of the drive circuits have been terminated by 50Ω near the ADC side. The termination is accomplished by a 25Ω resistor from each input to the 1.5V common-mode (VCM) from the device. This architecture allows the analog inputs to be biased around the required common-mode voltage.

The mismatch in the transformer parasitic capacitance (between the windings) results in degraded even-order harmonic performance. Connecting two identical RF transformers back-to-back helps minimize this mismatch; good performance is obtained for high-frequency input signals. An additional termination resistor pair may be required between the two transformers, as shown in [Figure 156](#), [Figure 157](#), and [Figure 158](#). The center point of this termination is connected to ground to improve the balance between the P and M sides. The values of the terminations between the transformers and on the secondary side must be chosen to obtain an effective 50Ω (in the case of 50Ω source impedance).



**Figure 156. Drive Circuit with Low Bandwidth (for Low Input Frequencies Less Than 150MHz)**

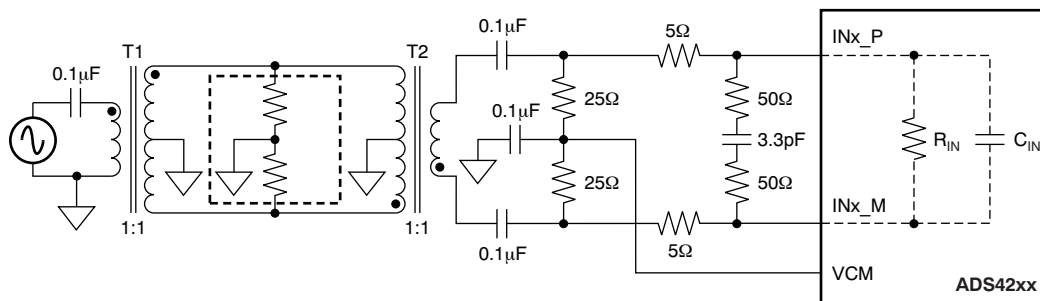

**Figure 157. Drive Circuit with High Bandwidth (for High Input Frequencies Greater Than 150MHz and Less Than 270MHz)**

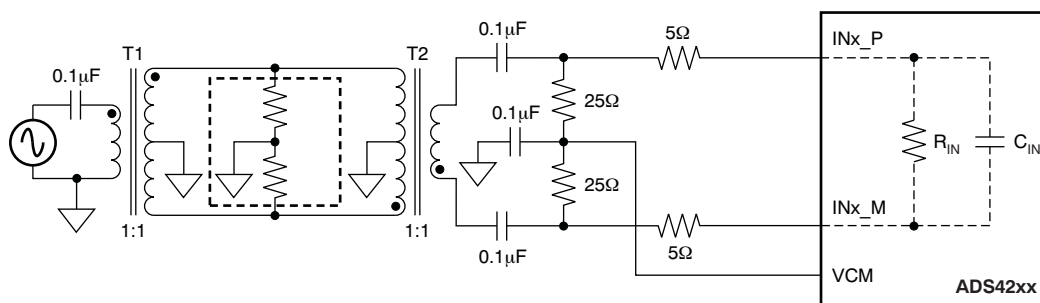

**Figure 158. Drive Circuit with Very High Bandwidth (Greater than 270MHz)**

All of these examples show 1:1 transformers being used with a 50Ω source. As explained in the *Drive Circuit Requirements* section, this configuration helps to present a low source impedance to absorb the sampling glitches. With a 1:4 transformer, the source impedance is 200Ω. The higher source impedance is unable to absorb the sampling glitches effectively and can lead to degradation in performance (compared to using 1:1 transformers).

In almost all cases, either a band-pass or low-pass filter is required to obtain the desired dynamic performance, as shown in *Figure 159*. Such filters present low source impedance at the high frequencies corresponding to the sampling glitch and help avoid the performance loss with the high source impedance.

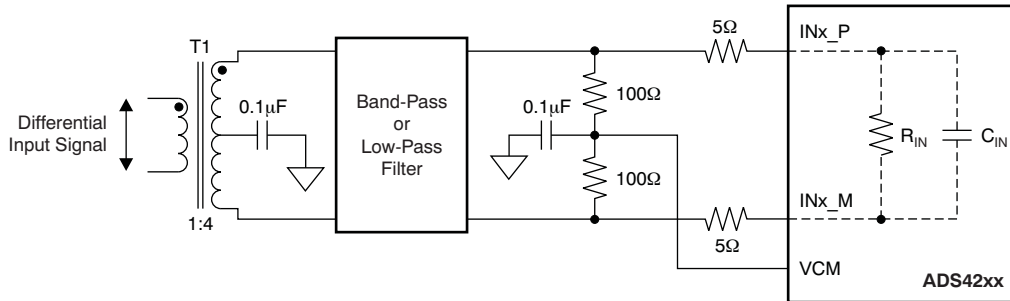

Figure 159. Drive Circuit with a 1:4 Transformer

## CLOCK INPUT

The ADS424x/422x clock inputs can be driven differentially (sine, LVPECL, or LVDS) or single-ended (LVCMOS), with little or no difference in performance between them. The common-mode voltage of the clock inputs is set to VCM using internal 5kΩ resistors. This setting allows the use of transformer-coupled drive circuits for sine-wave clock or ac-coupling for LVPECL and LVDS clock sources are shown in *Figure 160*, *Figure 161* and *Figure 162*. The internal clock buffer is shown in *Figure 163*.

(1)  $R_T$  = termination resistor, if necessary.

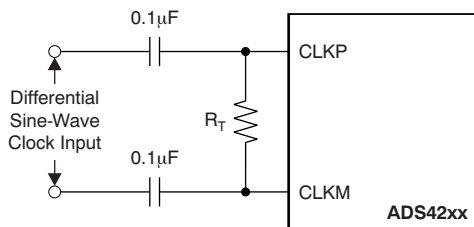

Figure 160. Differential Sine-Wave Clock Driving Circuit

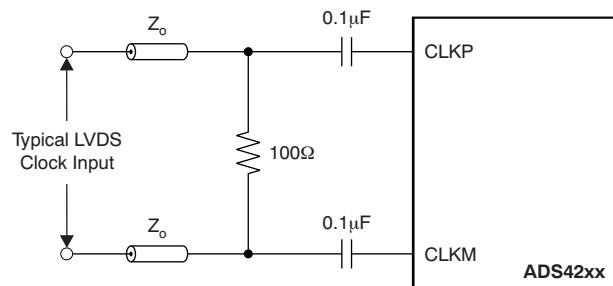

Figure 161. LVDS Clock Driving Circuit

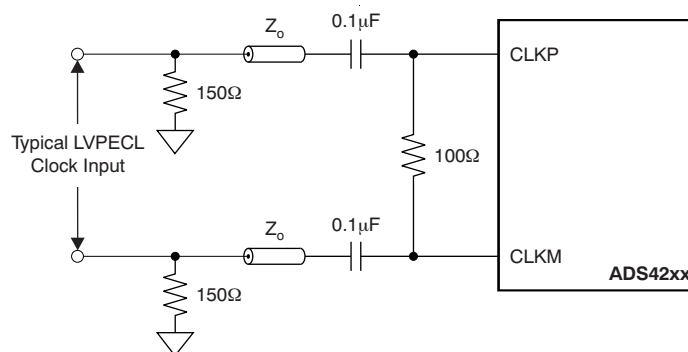
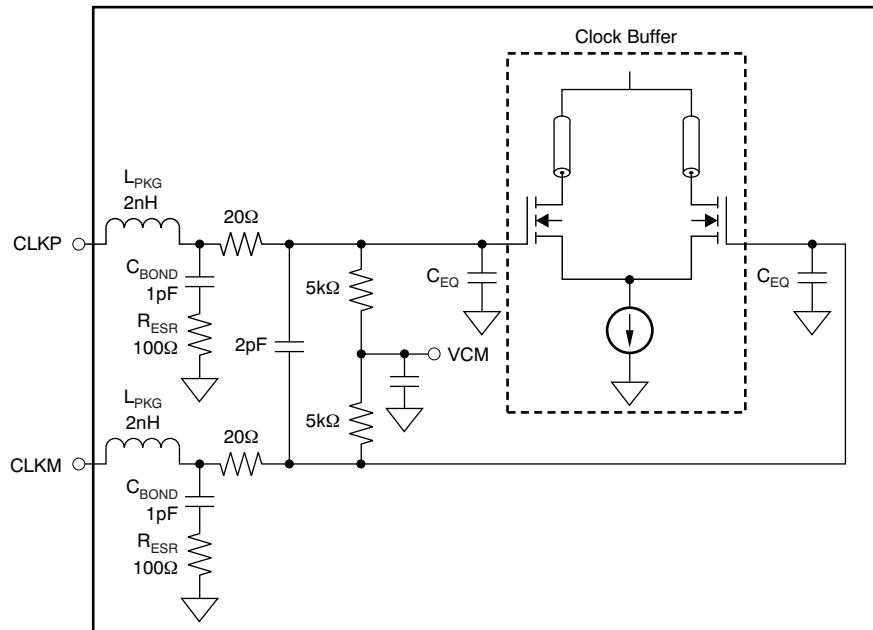

Figure 162. LVPECL Clock Driving Circuit



NOTE:  $C_{EQ}$  is 1pF to 3pF and is the equivalent input capacitance of the clock buffer.

**Figure 163. Internal Clock Buffer**

A single-ended CMOS clock can be ac-coupled to the CLKP input, with CLKM connected to ground with a 0.1μF capacitor, as shown in Figure 164. For best performance, the clock inputs must be driven differentially, thereby reducing susceptibility to common-mode noise. For high input frequency sampling, it is recommended to use a clock source with very low jitter. Band-pass filtering of the clock source can help reduce the effects of jitter. There is no change in performance with a non-50% duty cycle clock input.

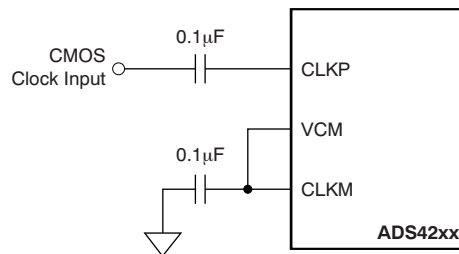

**Figure 164. Single-Ended Clock Driving Circuit**

## DIGITAL FUNCTIONS

The device has several useful digital functions (such as test patterns, gain, and offset correction). These functions require extra clock cycles for operation and increase the overall latency and power of the device. These digital functions are disabled by default after reset and the raw ADC output is routed to the output data pins with a latency of 16 clock cycles. Figure 165 shows more details of the processing after the ADC. In order to use any of the digital functions, the EN DIGITAL bit must be set to '1'. After this, the respective register bits must be programmed as described in the following sections and in the [Serial Register Map](#) section.

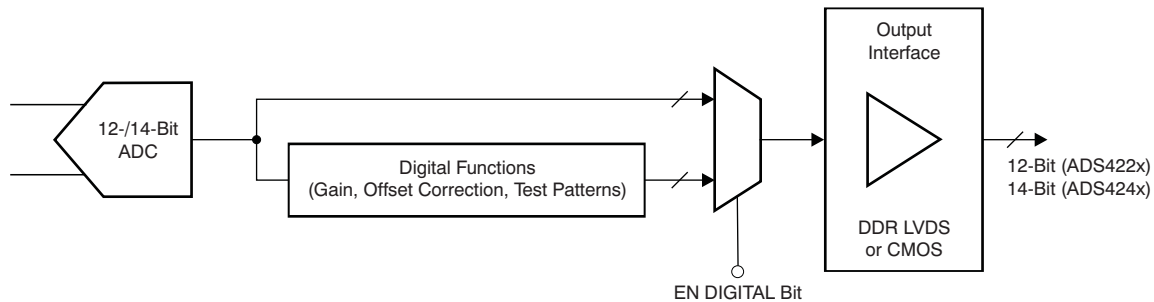

Figure 165. Digital Processing Block

## GAIN FOR SFDR/SNR TRADE-OFF

The ADS424x/422x include gain settings that can be used to get improved SFDR performance (compared to no gain). The gain is programmable from 0dB to 6dB (in 0.5dB steps). For each gain setting, the analog input full-scale range scales proportionally, as shown in [Table 11](#).

The SFDR improvement is achieved at the expense of SNR; for each gain setting, the SNR degrades approximately between 0.5dB and 1dB. The SNR degradation is reduced at high input frequencies. As a result, the gain is very useful at high input frequencies because the SFDR improvement is significant with marginal degradation in SNR. Therefore, the gain can be used as a trade-off between SFDR and SNR. Note that the default gain after reset is 0dB.

Table 11. Full-Scale Range Across Gains

GAIN (dB)	TYPE	FULL-SCALE (V <sub>PP</sub> )
0	Default after reset	2
1	Fine, programmable	1.78
2	Fine, programmable	1.59
3	Fine, programmable	1.42
4	Fine, programmable	1.26
5	Fine, programmable	1.12
6	Fine, programmable	1

## OFFSET CORRECTION

The ADS424x/422x have an internal offset correction algorithm that estimates and corrects dc offset up to  $\pm 10\text{mV}$ . The correction can be enabled using the ENABLE OFFSET CORR serial register bit. Once enabled, the algorithm estimates the channel offset and applies the correction every clock cycle. The time constant of the correction loop is a function of the sampling clock frequency. The time constant can be controlled using the OFFSET CORR TIME CONSTANT register bits, as described in [Table 12](#).

After the offset is estimated, the correction can be frozen by setting FREEZE OFFSET CORR = 0. Once frozen, the last estimated value is used for the offset correction of every clock cycle. Note that offset correction is disabled by default after reset.

**Table 12. Time Constant of Offset Correction Algorithm**

OFFSET CORR TIME CONSTANT	TIME CONSTANT, $T_{C_{CLK}}$ (Number of Clock Cycles)	TIME CONSTANT, $T_{C_{CLK}} \times 1/f_s$ (ms) <sup>(1)</sup>
0000	1M	7
0001	2M	13
0010	4M	26
0011	8M	52
0100	16M	105
0101	32M	210
0110	64M	419
0111	128M	839
1000	256M	1678
1001	512M	3355
1010	1G	6711
1011	2G	13422
1100	Reserved	—
1101	Reserved	—
1110	Reserved	—
1111	Reserved	—

(1) Sampling frequency,  $f_s = 160\text{MSPS}$ .

## POWER-DOWN

The ADS424x/422x have two power-down modes: global power-down and channel standby. These modes can be set using either the serial register bits or using the control pins CTRL1 to CTRL3 (as shown in [Table 13](#)).

**Table 13. Power-Down Settings**

CTRL1	CTRL2	CTRL3	DESCRIPTION
Low	Low	Low	Default
Low	Low	High	Not available
Low	High	Low	Not available
Low	High	High	Not available
High	Low	Low	Global power-down
High	Low	High	Channel A powered down, channel B is active
High	High	Low	Not available
High	High	High	MUX mode of operation, channel A and B data is multiplexed and output on DB[10:0] pins

### Global Power-Down

In this mode, the entire chip (including ADCs, internal reference, and output buffers) are powered down, resulting in reduced total power dissipation of approximately 20mW when the CTRL pins are used and 3mW when the PDN GLOBAL serial register bit is used. The output buffers are in high-impedance state. The wake-up time from global power-down to data becoming valid in normal mode is typically 100 $\mu$ s.

### Channel Standby

In this mode, each ADC channel can be powered down. The internal references are active, resulting in a quick wake-up time of 50 $\mu$ s. The total power dissipation in standby is approximately 200mW at 160MSPS.

### Input Clock Stop

In addition to the previous modes, the converter enters a low-power mode when the input clock frequency falls below 1MSPS. The power dissipation is approximately 160mW.

## DIGITAL OUTPUT INFORMATION

The ADS424x/422x provide 14-bit/12-bit digital data for each channel and an output clock synchronized with the data.

### Output Interface

Two output interface options are available: double data rate (DDR) LVDS and parallel CMOS. They can be selected using the serial interface register bit or by setting the proper voltage on the SEN pin in parallel configuration mode.

### DDR LVDS Outputs

In this mode, the data bits and clock are output using low-voltage differential signal (LVDS) levels. Two data bits are multiplexed and output on each LVDS differential pair, as shown in [Figure 166](#).

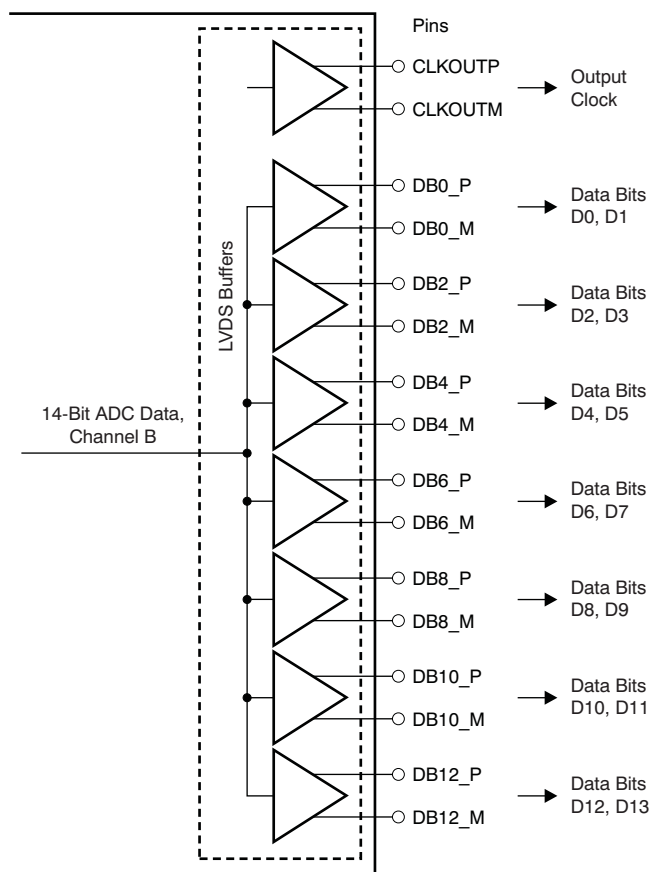

Figure 166. LVDS Interface

Even data bits (D0, D2, D4, etc.) are output at the CLKOUTP rising edge and the odd data bits (D1, D3, D5, etc.) are output at the CLKOUTP falling edge. Both the CLKOUTP rising and falling edges must be used to capture all the data bits, as shown in Figure 167.

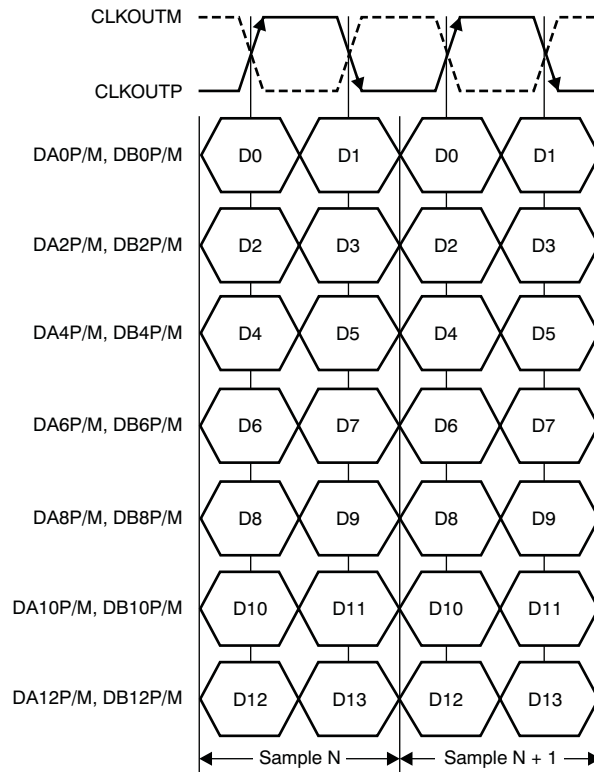
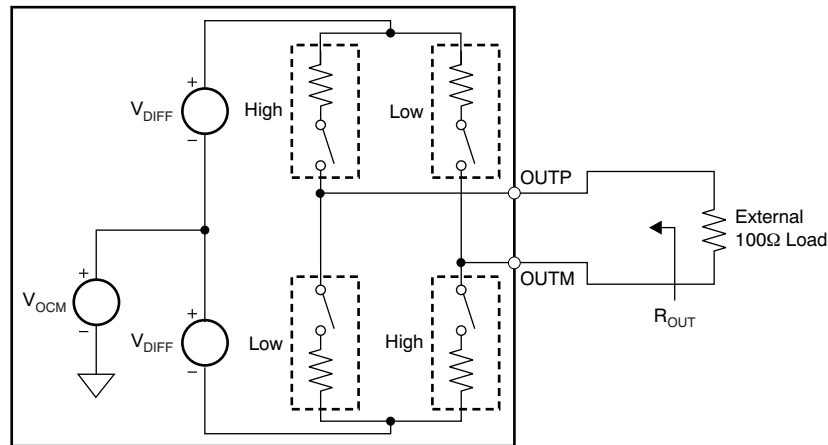

Figure 167. DDR LVDS Interface Timing

## LVDS Buffer

The equivalent circuit of each LVDS output buffer is shown in [Figure 168](#). After reset, the buffer presents an output impedance of 100Ω to match with the external 100Ω termination.



NOTE: Default swing across 100Ω load is ±350mV. Use the LVDS SWING bits to change the swing.

**Figure 168. LVDS Buffer Equivalent Circuit**

The  $V_{DIFF}$  voltage is nominally 350mV, resulting in an output swing of ±350mV with 100Ω external termination. The  $V_{DIFF}$  voltage is programmable using the LVDS SWING register bits from ±125mV to ±570mV.

Additionally, a mode exists to double the strength of the LVDS buffer to support 50Ω differential termination, as shown in [Figure 169](#). This mode can be used when the output LVDS signal is routed to two separate receiver chips, each using a 100Ω termination. The mode can be enabled using the LVDS DATA STRENGTH and LVDS CLKOUT STRENGTH register bits for data and output clock buffers, respectively.

The buffer output impedance behaves in the same way as a source-side series termination. By absorbing reflections from the receiver end, it helps to improve signal integrity.

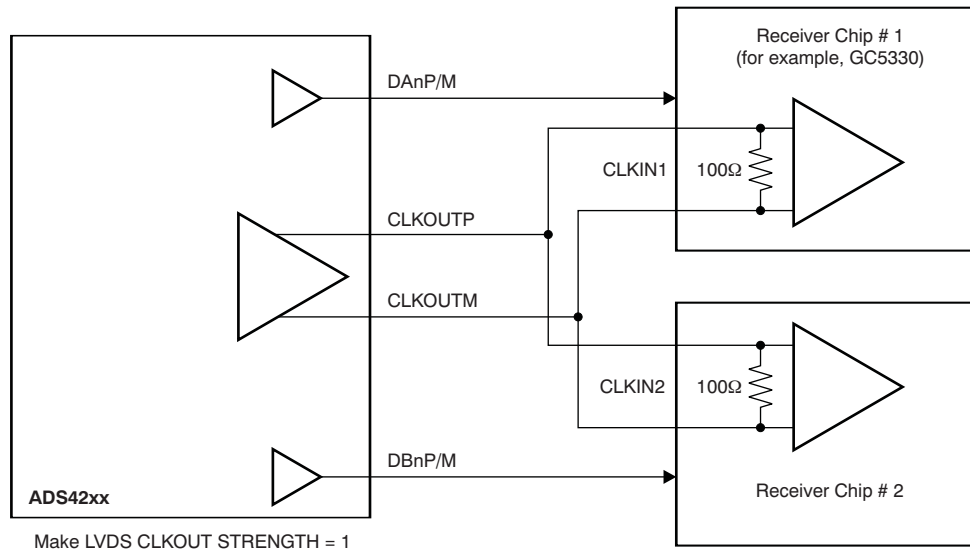

**Figure 169. LVDS Buffer Differential Termination**

### Parallel CMOS Interface

In the CMOS mode, each data bit is output on separate pins as CMOS voltage level, every clock cycle, as [Figure 170](#) shows. The rising edge of the output clock CLKOUT can be used to latch data in the receiver. It is recommended to minimize the load capacitance of the data and clock output pins by using short traces to the receiver. Furthermore, match the output data and clock traces to minimize the skew between them.

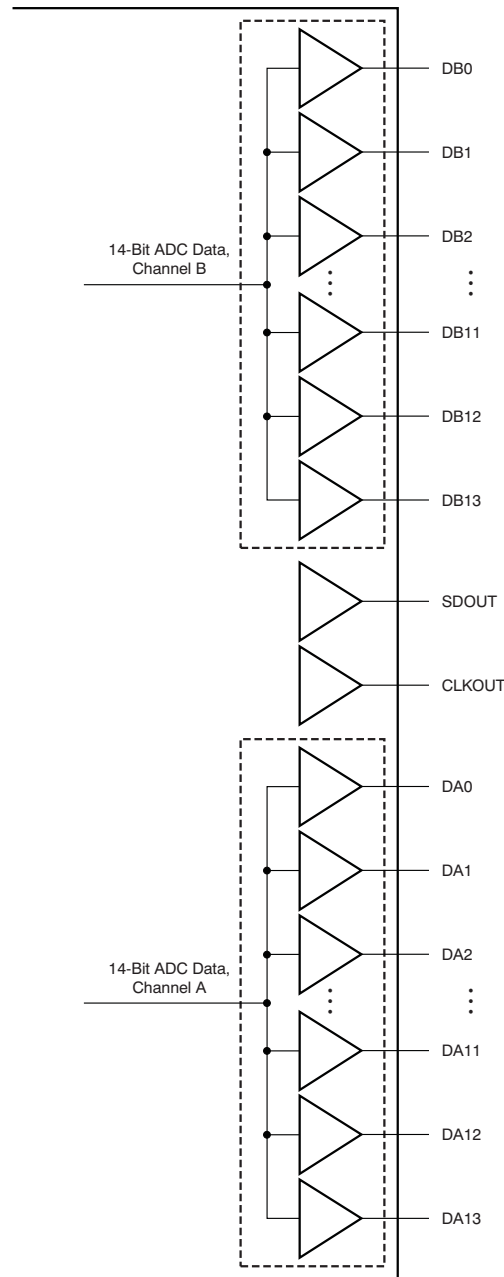

Figure 170. CMOS Outputs

## CMOS Interface Power Dissipation

With CMOS outputs, the DRVDD current scales with the sampling frequency and the load capacitance on every output pin. The maximum DRVDD current occurs when each output bit toggles between 0 and 1 every clock cycle. In actual applications, this condition is unlikely to occur. The actual DRVDD current would be determined by the average number of output bits switching, which is a function of the sampling frequency and the nature of the analog input signal. This relationship is shown by the formula:

$$\text{Digital current as a result of CMOS output switching} = C_L \times \text{DRVDD} \times (N \times F_{\text{AVG}}),$$

where  $C_L$  = load capacitance,  $N \times F_{\text{AVG}}$  = average number of output bits switching.

## Multiplexed Mode of Operation

In this mode, the digital outputs of both channels are multiplexed and output on a single bus (DB[13:0] pins), as shown in Figure 171. The channel A output pins (DA[13:0]) are in 3-state. Because the output data rate on the DB bus is effectively doubled, this mode is recommended only for low sampling frequencies (less than 80MSPS). This mode can be enabled using the POWER-DOWN MODE register bits or using the CTRL[3:1] parallel pins.

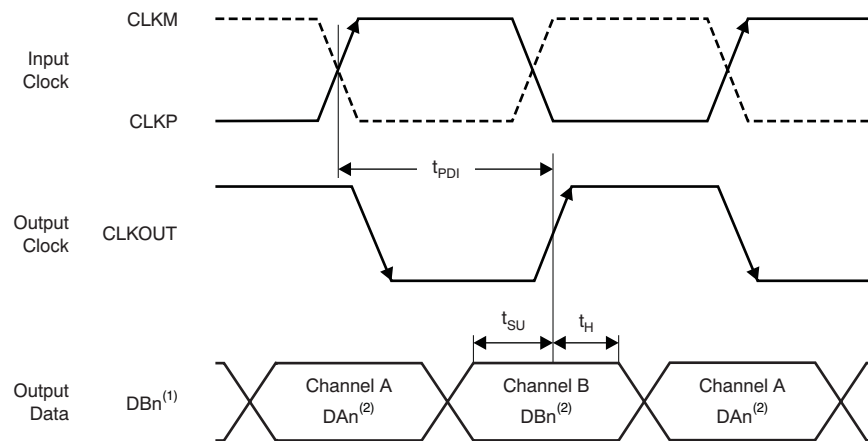

(1) In multiplexed mode, both channels outputs come on the channel B output pins.

(2) Dn = bits D0, D1, D2, etc.

Figure 171. Multiplexed Mode Timing Diagram

## Output Data Format

Two output data formats are supported: twos complement and offset binary. The format can be selected using the DATA FORMAT serial interface register bit or by controlling the DFS pin in parallel configuration mode.

In the event of an input voltage overdrive, the digital outputs go to the appropriate full-scale level. For a positive overdrive, the output code is FFFh for the ADS422x and 3FFFh for the ADS424x in offset binary output format; the output code is 7FFh for the ADS422x and 1FFFh for the ADS424x in twos complement output format. For a negative input overdrive, the output code is 0000h in offset binary output format and 800h for the ADS422x and 2000h for the ADS424x in twos complement output format.

## DEFINITION OF SPECIFICATIONS

**Analog Bandwidth** – The analog input frequency at which the power of the fundamental is reduced by 3 dB with respect to the low-frequency value.

**Aperture Delay** – The delay in time between the rising edge of the input sampling clock and the actual time at which the sampling occurs. This delay is different across channels. The maximum variation is specified as aperture delay variation (channel-to-channel).

**Aperture Uncertainty (Jitter)** – The sample-to-sample variation in aperture delay.

**Clock Pulse Width/Duty Cycle** – The duty cycle of a clock signal is the ratio of the time the clock signal remains at a logic high (clock pulse width) to the period of the clock signal. Duty cycle is typically expressed as a percentage. A perfect differential sine-wave clock results in a 50% duty cycle.

**Maximum Conversion Rate** – The maximum sampling rate at which specified operation is given. All parametric testing is performed at this sampling rate unless otherwise noted.

**Minimum Conversion Rate** – The minimum sampling rate at which the ADC functions.

**Differential Nonlinearity (DNL)** – An ideal ADC exhibits code transitions at analog input values spaced exactly 1LSB apart. The DNL is the deviation of any single step from this ideal value, measured in units of LSBs.

**Integral Nonlinearity (INL)** – The INL is the deviation of the ADC transfer function from a best fit line determined by a least squares curve fit of that transfer function, measured in units of LSBs.

**Gain Error** – Gain error is the deviation of the ADC actual input full-scale range from its ideal value. The gain error is given as a percentage of the ideal input full-scale range. Gain error has two components: error as a result of reference inaccuracy ( $E_{GREF}$ ) and error as a result of the channel ( $E_{GCHAN}$ ). Both errors are specified independently as  $E_{GREF}$  and  $E_{GCHAN}$ .

To a first-order approximation, the total gain error is  $E_{TOTAL} \sim E_{GREF} + E_{GCHAN}$ .

For example, if  $E_{TOTAL} = \pm 0.5\%$ , the full-scale input varies from  $(1 - 0.5/100) \times FS_{ideal}$  to  $(1 + 0.5/100) \times FS_{ideal}$ .

**Offset Error** – The offset error is the difference, given in number of LSBs, between the ADC actual average idle channel output code and the ideal average idle channel output code. This quantity is often mapped into millivolts.

**Temperature Drift** – The temperature drift coefficient (with respect to gain error and offset error) specifies the change per degree Celsius of the parameter from  $T_{MIN}$  to  $T_{MAX}$ . It is calculated by dividing the maximum deviation of the parameter across the  $T_{MIN}$  to  $T_{MAX}$  range by the difference  $T_{MAX} - T_{MIN}$ .

**Signal-to-Noise Ratio** – SNR is the ratio of the power of the fundamental ( $P_S$ ) to the noise floor power ( $P_N$ ), excluding the power at dc and the first nine harmonics.

$$SNR = 10\text{Log}^{10} \frac{P_S}{P_N} \quad (1)$$

SNR is either given in units of dBc (dB to carrier) when the absolute power of the fundamental is used as the reference, or dBFS (dB to full-scale) when the power of the fundamental is extrapolated to the converter full-scale range.

**Signal-to-Noise and Distortion (SINAD)** – SINAD is the ratio of the power of the fundamental ( $P_S$ ) to the power of all the other spectral components including noise ( $P_N$ ) and distortion ( $P_D$ ), but excluding dc.

$$SINAD = 10\text{Log}^{10} \frac{P_S}{P_N + P_D} \quad (2)$$

SINAD is either given in units of dBc (dB to carrier) when the absolute power of the fundamental is used as the reference, or dBFS (dB to full-scale) when the power of the fundamental is extrapolated to the converter full-scale range.

**Effective Number of Bits (ENOB)** – ENOB is a measure of the converter performance as compared to the theoretical limit based on quantization noise.

$$\text{ENOB} = \frac{\text{SINAD} - 1.76}{6.02} \quad (3)$$

**Total Harmonic Distortion (THD)** – THD is the ratio of the power of the fundamental ( $P_S$ ) to the power of the first nine harmonics ( $P_D$ ).

$$\text{THD} = 10\text{Log}^{10} \frac{P_S}{P_N} \quad (4)$$

THD is typically given in units of dBc (dB to carrier).

**Spurious-Free Dynamic Range (SFDR)** – The ratio of the power of the fundamental to the highest other spectral component (either spur or harmonic). SFDR is typically given in units of dBc (dB to carrier).

**Two-Tone Intermodulation Distortion** – IMD3 is the ratio of the power of the fundamental (at frequencies  $f_1$  and  $f_2$ ) to the power of the worst spectral component at either frequency  $2f_1 - f_2$  or  $2f_2 - f_1$ . IMD3 is either given in units of dBc (dB to carrier) when the absolute power of the fundamental is used as the reference, or dBFS (dB to full-scale) when the power of the fundamental is extrapolated to the converter full-scale range.

**DC Power-Supply Rejection Ratio (DC PSRR)** – DC PSRR is the ratio of the change in offset error to a change in analog supply voltage. The dc PSRR is typically given in units of mV/V.

**AC Power-Supply Rejection Ratio (AC PSRR)** – AC PSRR is the measure of rejection of variations in the supply voltage by the ADC. If  $\Delta V_{\text{SUP}}$  is the change in supply voltage and  $\Delta V_{\text{OUT}}$  is the resultant change of the ADC output code (referred to the input), then:

$$\text{PSRR} = 20\text{Log}^{10} \frac{\Delta V_{\text{OUT}}}{\Delta V_{\text{SUP}}} \quad (\text{Expressed in dBc}) \quad (5)$$

**Voltage Overload Recovery** – The number of clock cycles taken to recover to less than 1% error after an overload on the analog inputs. This is tested by separately applying a sine wave signal with 6 dB positive and negative overload. The deviation of the first few samples after the overload (from the expected values) is noted.

**Common-Mode Rejection Ratio (CMRR)** – CMRR is the measure of rejection of variation in the analog input common-mode by the ADC. If  $\Delta V_{\text{CM\_IN}}$  is the change in the common-mode voltage of the input pins and  $\Delta V_{\text{OUT}}$  is the resulting change of the ADC output code (referred to the input), then:

$$\text{CMRR} = 20\text{Log}^{10} \frac{\Delta V_{\text{OUT}}}{\Delta V_{\text{CM}}} \quad (\text{Expressed in dBc}) \quad (6)$$

**Crosstalk (only for multi-channel ADCs)** – This is a measure of the internal coupling of a signal from an adjacent channel into the channel of interest. It is specified separately for coupling from the immediate neighboring channel (near-channel) and for coupling from channel across the package (far-channel). It is usually measured by applying a full-scale signal in the adjacent channel. Crosstalk is the ratio of the power of the coupling signal (as measured at the output of the channel of interest) to the power of the signal applied at the adjacent channel input. It is typically expressed in dBc.

## BOARD DESIGN CONSIDERATIONS

### Grounding

A single ground plane is sufficient to give good performance, provided the analog, digital, and clock sections of the board are cleanly partitioned. See the [ADS4226 Evaluation Module \(SLAU333\)](#) for details on layout and grounding.

### Supply Decoupling

Because the ADS424x/422x already include internal decoupling, minimal external decoupling can be used without loss in performance. Note that decoupling capacitors can help filter external power-supply noise; thus, the optimum number of capacitors depends on the actual application. The decoupling capacitors should be placed very close to the converter supply pins.

### Exposed Pad

In addition to providing a path for heat dissipation, the PowerPAD is also electrically connected internally to the digital ground. Therefore, it is necessary to solder the exposed pad to the ground plane for best thermal and electrical performance. For detailed information, see application notes [QFN Layout Guidelines \(SLOA122\)](#) and [QFN/SON PCB Attachment \(SLUA271\)](#).

## Routing Analog Inputs

It is advisable to route differential analog input pairs (INP\_x and INM\_x) close to each other. To minimize the possibility of coupling from a channel analog input to the sampling clock, the analog input pairs of both channels should be routed perpendicular to the sampling clock. See the [ADS4226 Evaluation Module \(SLAU333\)](#) for reference routing. [Figure 172](#) shows a snapshot of the PCB layout from the ADS424x EVM.

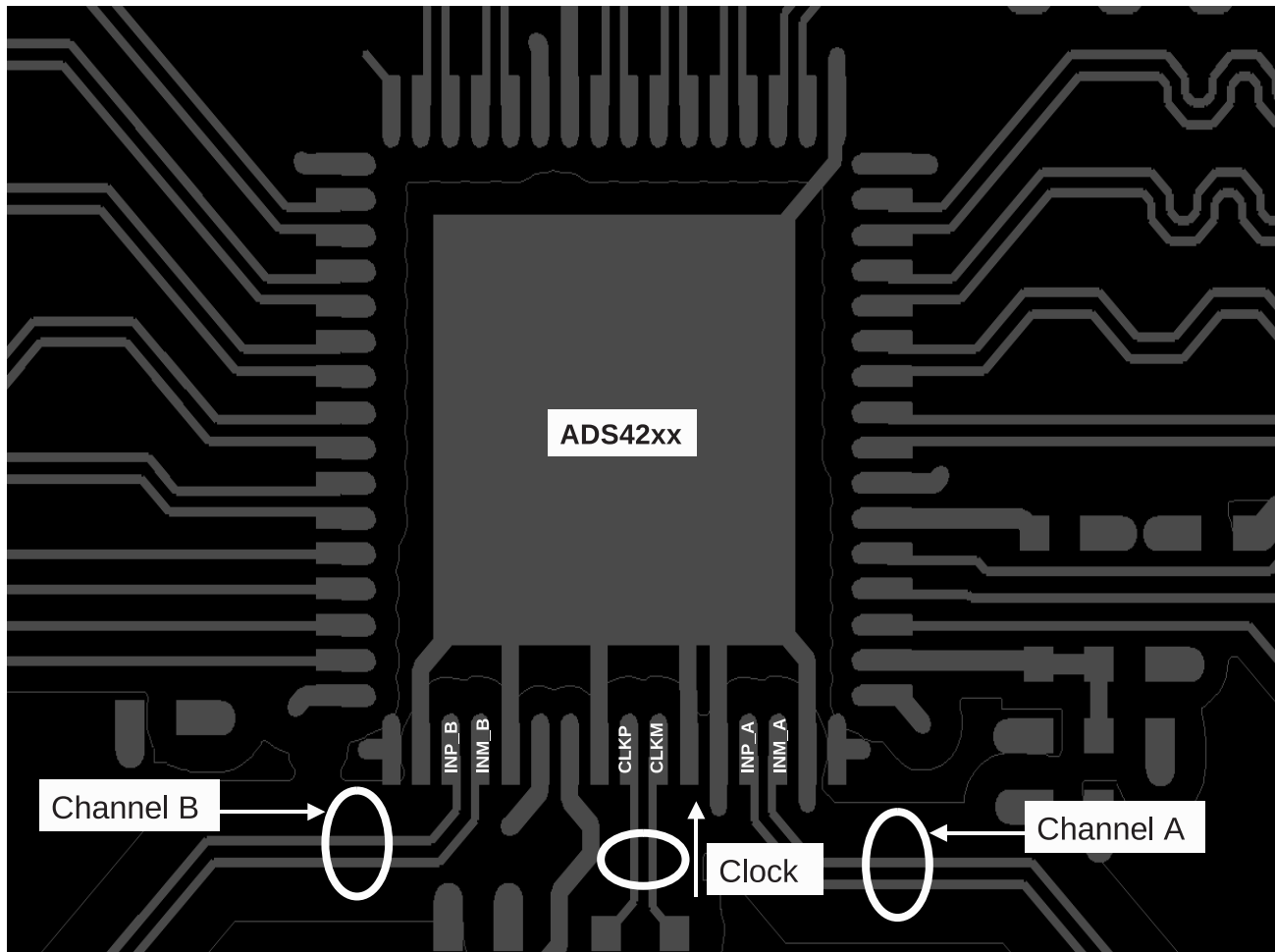

Figure 172. ADS42xx EVM PCB Layout

## REVISION HISTORY

NOTE: Page numbers for previous revisions may differ from page numbers in the current version.

<b>Changes from Revision B (May 2011) to Revision C</b>	<b>Page</b>
• Changed device status from Mixed Status to Production Data .....	1
• Changed 125MSPS sub-bullet of first Features bullet .....	1
• Changed sub-bullets of second Features bullet .....	1
• Changed status of ADS4222 and ADS4225 from Product Preview to Production Data .....	2
• Moved High-Performance Modes into separate table .....	4
• Changed ADS4246 $f_{IN} = 170\text{MHz}$ <i>Worst spur</i> typical specification in the ADS4246/ADS4245/ADS4242 Electrical Characteristics table .....	5
• Added ADS4225/ADS4222 $f_{IN} = 70\text{MHz}$ <i>SNR</i> , <i>SINAD</i> , <i>SFDR</i> , <i>THD</i> , <i>HD2</i> , <i>HD3</i> , and <i>Worst spur</i> minimum and typical specifications in the ADS4226/ADS4225/ADS4222 Electrical Characteristics table .....	7
• Added ADS4225/ADS4222 <i>DNL</i> minimum and maximum specifications in the ADS4226/ADS4225/ADS4222 Electrical Characteristics table .....	8
• Added ADS4225/ADS4222 <i>INL</i> maximum specifications in the ADS4226/ADS4225/ADS4222 Electrical Characteristics table .....	8
• Changed ADS4242/ADS4222 Power Supply, <i>Digital power LVDS interface</i> typical specification in Electrical Characteristics: General table .....	9
• Changed ADS4245/ADS4225 Power Supply, <i>Digital power CMOS interface</i> typical specification in Electrical Characteristics: General table .....	9
• Changed description of pin 64 in Pin Descriptions: LVDS Mode table .....	13
• Changed description of pin 64 in Pin Descriptions: CMOS Mode table .....	17
• Changed description of READOUT disabled in <i>Serial Register Readout</i> section .....	27
• Updated <a href="#">Figure 14</a> .....	27
• Changed READOUT description in <i>Register Address 00h</i> section .....	29
• Changed CLKOUT FALL POSN and CLKOUT RISE POSN description in <i>Register Address 42h</i> section .....	34

Changes from Revision A (May 2011) to Revision B	Page
• Changed sub-bullets of first Features bullet .....	1
• Changed last row of Performance Summary table .....	1
• Updated ADS424x/422x Family <i>Pins</i> section in <a href="#">Table 1</a> .....	2
• Changed <i>ENOB</i> , <i>DNL</i> , and <i>INL</i> test conditions in the Electrical Characteristics: ADS4246/ADS4245/ADS4242 table .....	6
• Deleted <i>INL</i> minimum specifications from Electrical Characteristics: ADS4246/ADS4245/ADS4242 table .....	6
• Changed <i>INL</i> maximum specifications in the Electrical Characteristics: ADS4246/ADS4245/ADS4242 table .....	6
• Changed <i>ENOB</i> , <i>DNL</i> , and <i>INL</i> test conditions in the Electrical Characteristics: ADS4226/ADS4225/ADS4222 table .....	8
• Changed ADS4226 <i>INL</i> maximum specification in the Electrical Characteristics: ADS4226/ADS4225/ADS4222 table .....	8
• Changed Power Supply, <i>IDRVDD</i> and <i>Digital power</i> CMOS interface rows in the Electrical Characteristics: General table .....	9
• Updated <a href="#">Figure 2</a> NC note .....	11
• Updated <a href="#">Figure 3</a> NC note .....	12
• Updated description of NC pin in LVDS Pin Descriptions table .....	14
• Updated <a href="#">Figure 4</a> NC note .....	15
• Updated <a href="#">Figure 5</a> NC note .....	16
• Updated description of NC pin in CMOS Pin Descriptions table .....	17
• Changed <i>111110</i> and <i>001111</i> LVDS SWING description in Register Address 01h .....	29
• Updated <a href="#">Figure 26</a> .....	42
• Updated <a href="#">Figure 28</a> .....	43
• Updated <a href="#">Figure 48</a> and <a href="#">Figure 49</a> .....	48
• Updated <a href="#">Figure 50</a> and <a href="#">Figure 51</a> .....	49
• Updated <a href="#">Figure 70</a> and <a href="#">Figure 71</a> .....	54
• Updated <a href="#">Figure 72</a> and <a href="#">Figure 73</a> .....	55
• Updated <a href="#">Figure 92</a> and <a href="#">Figure 93</a> .....	60
• Updated <a href="#">Figure 94</a> and <a href="#">Figure 95</a> .....	61
• Updated <a href="#">Figure 113</a> .....	65
• Updated <a href="#">Figure 114</a> and <a href="#">Figure 115</a> .....	66
• Updated <a href="#">Figure 133</a> .....	70
• Updated <a href="#">Figure 145</a> .....	73
• Changed title of <a href="#">Figure 146</a> .....	74

**PACKAGING INFORMATION**

Orderable Device	Status <sup>(1)</sup>	Package Type	Package Drawing	Pins	Package Qty	Eco Plan <sup>(2)</sup>	Lead/ Ball Finish	MSL Peak Temp <sup>(3)</sup>	Samples (Requires Login)
ADS4222IRGCR	ACTIVE	VQFN	RGC	64	2000	Green (RoHS & no Sb/Br)	CU NIPDAU	Level-3-260C-168 HR	
ADS4222IRGCT	ACTIVE	VQFN	RGC	64	250	Green (RoHS & no Sb/Br)	CU NIPDAU	Level-3-260C-168 HR	
ADS4225IRGC25	ACTIVE	VQFN	RGC	64	25	Green (RoHS & no Sb/Br)	CU NIPDAU	Level-3-260C-168 HR	
ADS4225IRGCR	ACTIVE	VQFN	RGC	64	2000	Green (RoHS & no Sb/Br)	CU NIPDAU	Level-3-260C-168 HR	
ADS4225IRGCT	ACTIVE	VQFN	RGC	64	250	Green (RoHS & no Sb/Br)	CU NIPDAU	Level-3-260C-168 HR	
ADS4226IRGC25	ACTIVE	VQFN	RGC	64	25	Green (RoHS & no Sb/Br)	CU NIPDAU	Level-3-260C-168 HR	
ADS4226IRGCR	ACTIVE	VQFN	RGC	64	2000	Green (RoHS & no Sb/Br)	CU NIPDAU	Level-3-260C-168 HR	
ADS4226IRGCT	ACTIVE	VQFN	RGC	64	250	Green (RoHS & no Sb/Br)	CU NIPDAU	Level-3-260C-168 HR	
ADS4242IRGCR	ACTIVE	VQFN	RGC	64	2000	Green (RoHS & no Sb/Br)	CU NIPDAU	Level-3-260C-168 HR	
ADS4242IRGCT	ACTIVE	VQFN	RGC	64	250	Green (RoHS & no Sb/Br)	CU NIPDAU	Level-3-260C-168 HR	
ADS4245IRGC25	ACTIVE	VQFN	RGC	64	25	Green (RoHS & no Sb/Br)	CU NIPDAU	Level-3-260C-168 HR	
ADS4245IRGCR	ACTIVE	VQFN	RGC	64	2000	Green (RoHS & no Sb/Br)	CU NIPDAU	Level-3-260C-168 HR	
ADS4245IRGCT	ACTIVE	VQFN	RGC	64	250	Green (RoHS & no Sb/Br)	CU NIPDAU	Level-3-260C-168 HR	
ADS4246IRGC25	ACTIVE	VQFN	RGC	64	25	Green (RoHS & no Sb/Br)	CU NIPDAU	Level-3-260C-168 HR	
ADS4246IRGCR	ACTIVE	VQFN	RGC	64	2000	Green (RoHS & no Sb/Br)	CU NIPDAU	Level-3-260C-168 HR	
ADS4246IRGCT	ACTIVE	VQFN	RGC	64	250	Green (RoHS & no Sb/Br)	CU NIPDAU	Level-3-260C-168 HR	

<sup>(1)</sup> The marketing status values are defined as follows:

---

**ACTIVE:** Product device recommended for new designs.

**LIFEBUY:** TI has announced that the device will be discontinued, and a lifetime-buy period is in effect.

**NRND:** Not recommended for new designs. Device is in production to support existing customers, but TI does not recommend using this part in a new design.

**PREVIEW:** Device has been announced but is not in production. Samples may or may not be available.

**OBSOLETE:** TI has discontinued the production of the device.

<sup>(2)</sup> Eco Plan - The planned eco-friendly classification: Pb-Free (RoHS), Pb-Free (RoHS Exempt), or Green (RoHS & no Sb/Br) - please check <http://www.ti.com/productcontent> for the latest availability information and additional product content details.

**TBD:** The Pb-Free/Green conversion plan has not been defined.

**Pb-Free (RoHS):** TI's terms "Lead-Free" or "Pb-Free" mean semiconductor products that are compatible with the current RoHS requirements for all 6 substances, including the requirement that lead not exceed 0.1% by weight in homogeneous materials. Where designed to be soldered at high temperatures, TI Pb-Free products are suitable for use in specified lead-free processes.

**Pb-Free (RoHS Exempt):** This component has a RoHS exemption for either 1) lead-based flip-chip solder bumps used between the die and package, or 2) lead-based die adhesive used between the die and leadframe. The component is otherwise considered Pb-Free (RoHS compatible) as defined above.

**Green (RoHS & no Sb/Br):** TI defines "Green" to mean Pb-Free (RoHS compatible), and free of Bromine (Br) and Antimony (Sb) based flame retardants (Br or Sb do not exceed 0.1% by weight in homogeneous material)

<sup>(3)</sup> MSL, Peak Temp. -- The Moisture Sensitivity Level rating according to the JEDEC industry standard classifications, and peak solder temperature.

**Important Information and Disclaimer:** The information provided on this page represents TI's knowledge and belief as of the date that it is provided. TI bases its knowledge and belief on information provided by third parties, and makes no representation or warranty as to the accuracy of such information. Efforts are underway to better integrate information from third parties. TI has taken and continues to take reasonable steps to provide representative and accurate information but may not have conducted destructive testing or chemical analysis on incoming materials and chemicals. TI and TI suppliers consider certain information to be proprietary, and thus CAS numbers and other limited information may not be available for release.

In no event shall TI's liability arising out of such information exceed the total purchase price of the TI part(s) at issue in this document sold by TI to Customer on an annual basis.

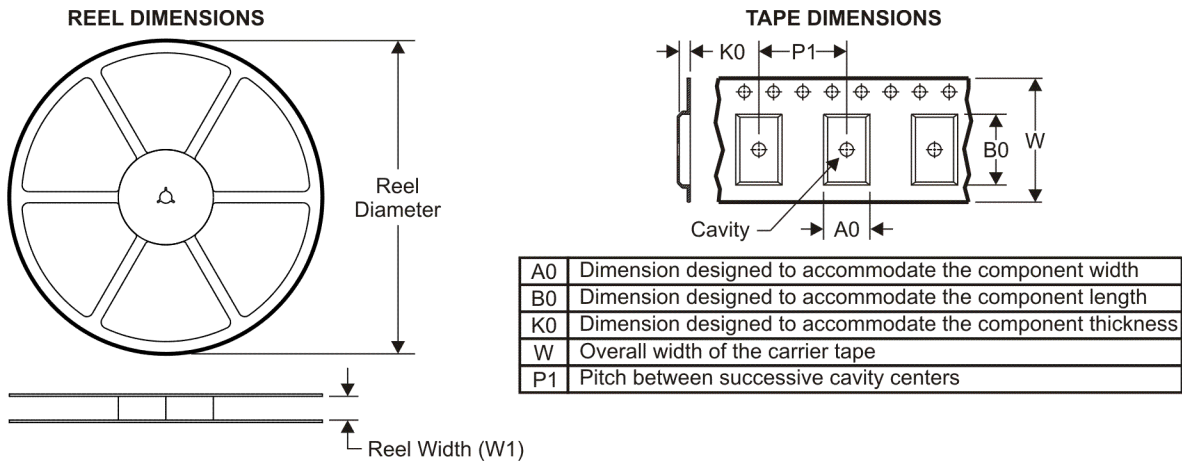
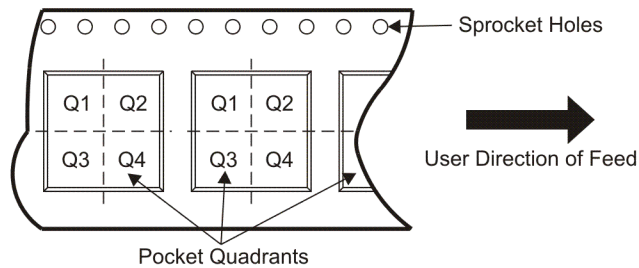
**TAPE AND REEL INFORMATION**

**QUADRANT ASSIGNMENTS FOR PIN 1 ORIENTATION IN TAPE**

\*All dimensions are nominal

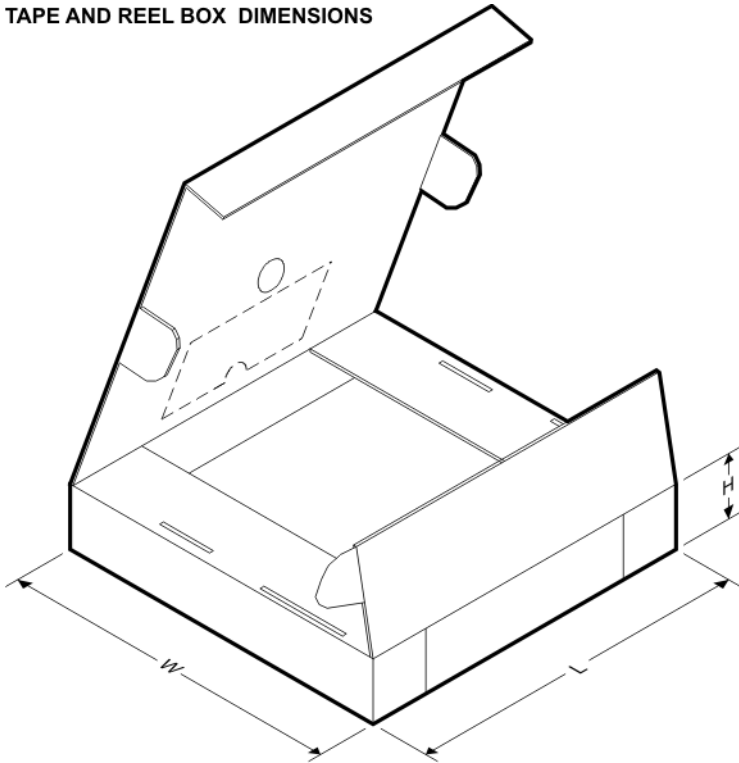
Device	Package Type	Package Drawing	Pins	SPQ	Reel Diameter (mm)	Reel Width W1 (mm)	A0 (mm)	B0 (mm)	K0 (mm)	P1 (mm)	W (mm)	Pin1 Quadrant
ADS4222IRGCR	VQFN	RGC	64	2000	330.0	16.4	9.3	9.3	1.5	12.0	16.0	Q2
ADS4222IRGCT	VQFN	RGC	64	250	330.0	16.4	9.3	9.3	1.5	12.0	16.0	Q2
ADS4225IRGCR	VQFN	RGC	64	2000	330.0	16.4	9.3	9.3	1.5	12.0	16.0	Q2
ADS4225IRGCT	VQFN	RGC	64	250	330.0	16.4	9.3	9.3	1.5	12.0	16.0	Q2
ADS4226IRGCR	VQFN	RGC	64	2000	330.0	16.4	9.3	9.3	1.5	12.0	16.0	Q2
ADS4226IRGCT	VQFN	RGC	64	250	330.0	16.4	9.3	9.3	1.5	12.0	16.0	Q2
ADS4242IRGCR	VQFN	RGC	64	2000	330.0	16.4	9.3	9.3	1.5	12.0	16.0	Q2
ADS4242IRGCT	VQFN	RGC	64	250	330.0	16.4	9.3	9.3	1.5	12.0	16.0	Q2
ADS4245IRGCR	VQFN	RGC	64	2000	330.0	16.4	9.3	9.3	1.5	12.0	16.0	Q2
ADS4245IRGCT	VQFN	RGC	64	250	330.0	16.4	9.3	9.3	1.5	12.0	16.0	Q2
ADS4246IRGCR	VQFN	RGC	64	2000	330.0	16.4	9.3	9.3	1.5	12.0	16.0	Q2
ADS4246IRGCT	VQFN	RGC	64	250	330.0	16.4	9.3	9.3	1.5	12.0	16.0	Q2

**TAPE AND REEL BOX DIMENSIONS**

\*All dimensions are nominal

Device	Package Type	Package Drawing	Pins	SPQ	Length (mm)	Width (mm)	Height (mm)
ADS4222IRGCR	VQFN	RGC	64	2000	333.2	345.9	28.6
ADS4222IRGCT	VQFN	RGC	64	250	333.2	345.9	28.6
ADS4225IRGCR	VQFN	RGC	64	2000	333.2	345.9	28.6
ADS4225IRGCT	VQFN	RGC	64	250	333.2	345.9	28.6
ADS4226IRGCR	VQFN	RGC	64	2000	333.2	345.9	28.6
ADS4226IRGCT	VQFN	RGC	64	250	333.2	345.9	28.6
ADS4242IRGCR	VQFN	RGC	64	2000	333.2	345.9	28.6
ADS4242IRGCT	VQFN	RGC	64	250	333.2	345.9	28.6
ADS4245IRGCR	VQFN	RGC	64	2000	333.2	345.9	28.6
ADS4245IRGCT	VQFN	RGC	64	250	333.2	345.9	28.6
ADS4246IRGCR	VQFN	RGC	64	2000	333.2	345.9	28.6
ADS4246IRGCT	VQFN	RGC	64	250	333.2	345.9	28.6



# THERMAL PAD MECHANICAL DATA

RGC (S-PVQFN-N64)

PLASTIC QUAD FLATPACK NO-LEAD

## THERMAL INFORMATION

This package incorporates an exposed thermal pad that is designed to be attached directly to an external heatsink. The thermal pad must be soldered directly to the printed circuit board (PCB). After soldering, the PCB can be used as a heatsink. In addition, through the use of thermal vias, the thermal pad can be attached directly to the appropriate copper plane shown in the electrical schematic for the device, or alternatively, can be attached to a special heatsink structure designed into the PCB. This design optimizes the heat transfer from the integrated circuit (IC).

For information on the Quad Flatpack No-Lead (QFN) package and its advantages, refer to Application Report, QFN/SON PCB Attachment, Texas Instruments Literature No. SLUA271. This document is available at [www.ti.com](http://www.ti.com).

The exposed thermal pad dimensions for this package are shown in the following illustration.

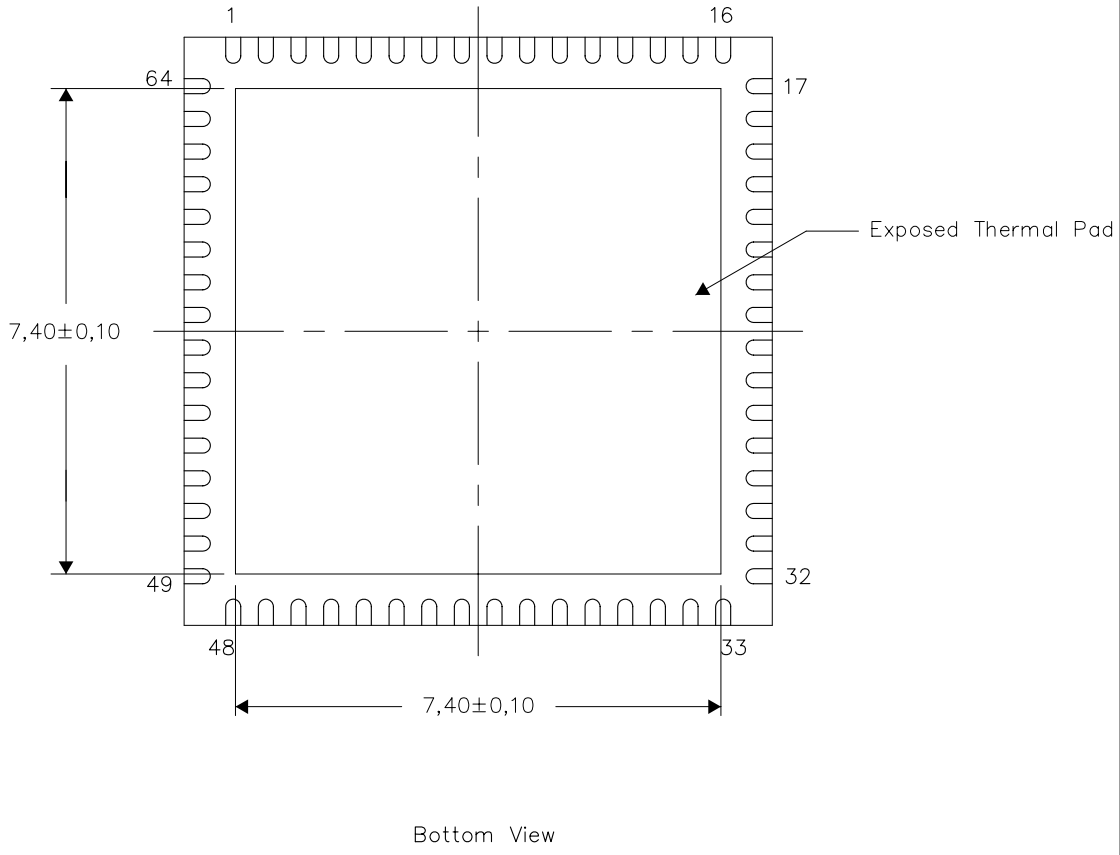

Exposed Thermal Pad Dimensions

4206192-4/0 04/11

NOTE: A. All linear dimensions are in millimeters

RGC (S-PVQFN-N64)

PLASTIC QUAD FLATPACK NO-LEAD

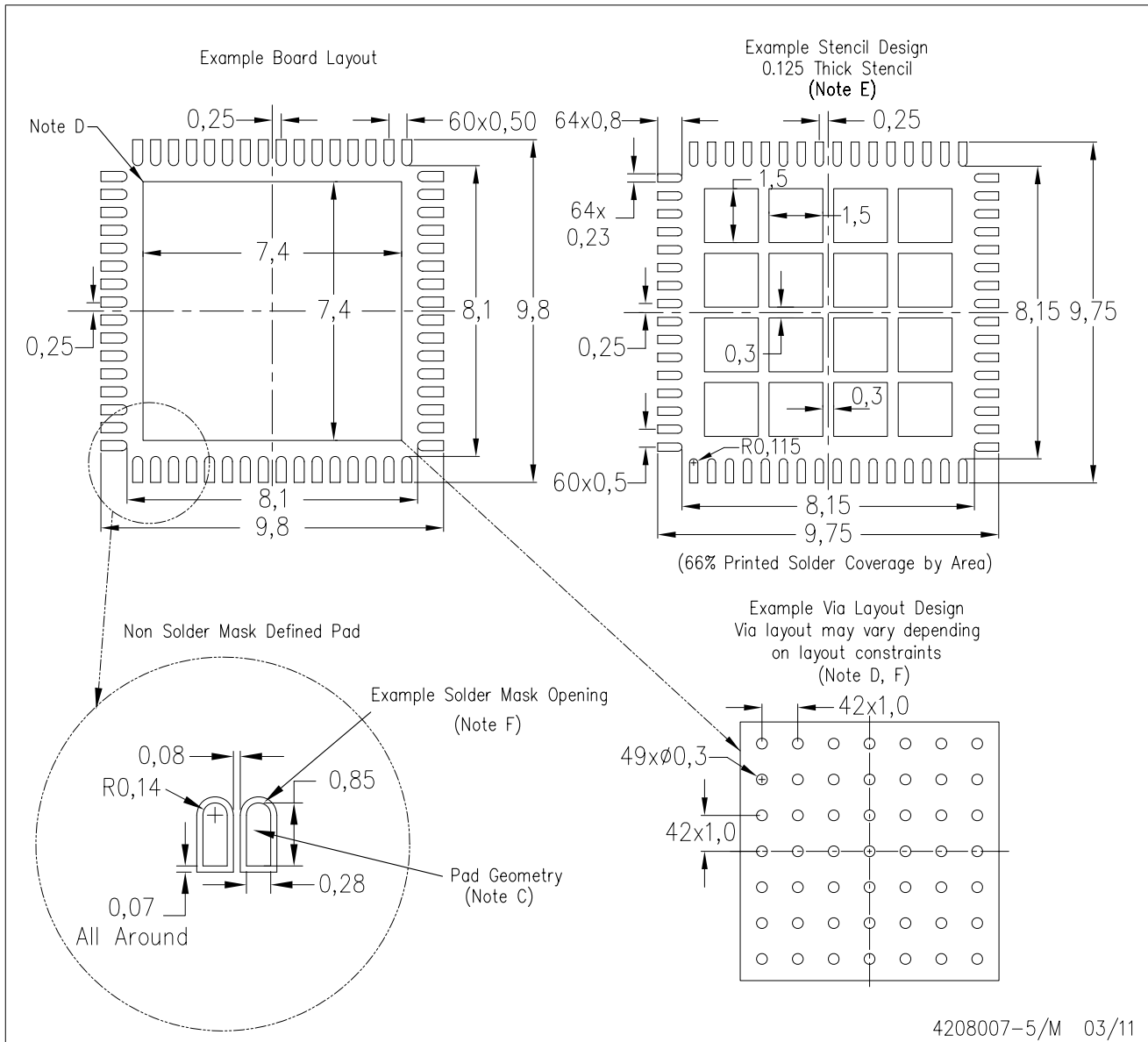

4208007-5/M 03/11

- NOTES:
- All linear dimensions are in millimeters.
  - This drawing is subject to change without notice.
  - Publication IPC-7351 is recommended for alternate designs.
  - This package is designed to be soldered to a thermal pad on the board. Refer to Application Note, Quad Flat-Pack Packages, Texas Instruments Literature No. SLUA271, and also the Product Data Sheets for specific thermal information, via requirements, and recommended board layout. These documents are available at [www.ti.com](http://www.ti.com) <<http://www.ti.com>>.
  - Laser cutting apertures with trapezoidal walls and also rounding corners will offer better paste release. Customers should contact their board assembly site for stencil design recommendations. Refer to IPC 7525 for stencil design considerations.
  - Customers should contact their board fabrication site for recommended solder mask tolerances and via tenting recommendations for vias placed in thermal pad.

## IMPORTANT NOTICE

Texas Instruments Incorporated and its subsidiaries (TI) reserve the right to make corrections, modifications, enhancements, improvements, and other changes to its products and services at any time and to discontinue any product or service without notice. Customers should obtain the latest relevant information before placing orders and should verify that such information is current and complete. All products are sold subject to TI's terms and conditions of sale supplied at the time of order acknowledgment.

TI warrants performance of its hardware products to the specifications applicable at the time of sale in accordance with TI's standard warranty. Testing and other quality control techniques are used to the extent TI deems necessary to support this warranty. Except where mandated by government requirements, testing of all parameters of each product is not necessarily performed.

TI assumes no liability for applications assistance or customer product design. Customers are responsible for their products and applications using TI components. To minimize the risks associated with customer products and applications, customers should provide adequate design and operating safeguards.

TI does not warrant or represent that any license, either express or implied, is granted under any TI patent right, copyright, mask work right, or other TI intellectual property right relating to any combination, machine, or process in which TI products or services are used. Information published by TI regarding third-party products or services does not constitute a license from TI to use such products or services or a warranty or endorsement thereof. Use of such information may require a license from a third party under the patents or other intellectual property of the third party, or a license from TI under the patents or other intellectual property of TI.

Reproduction of TI information in TI data books or data sheets is permissible only if reproduction is without alteration and is accompanied by all associated warranties, conditions, limitations, and notices. Reproduction of this information with alteration is an unfair and deceptive business practice. TI is not responsible or liable for such altered documentation. Information of third parties may be subject to additional restrictions.

Resale of TI products or services with statements different from or beyond the parameters stated by TI for that product or service voids all express and any implied warranties for the associated TI product or service and is an unfair and deceptive business practice. TI is not responsible or liable for any such statements.

TI products are not authorized for use in safety-critical applications (such as life support) where a failure of the TI product would reasonably be expected to cause severe personal injury or death, unless officers of the parties have executed an agreement specifically governing such use. Buyers represent that they have all necessary expertise in the safety and regulatory ramifications of their applications, and acknowledge and agree that they are solely responsible for all legal, regulatory and safety-related requirements concerning their products and any use of TI products in such safety-critical applications, notwithstanding any applications-related information or support that may be provided by TI. Further, Buyers must fully indemnify TI and its representatives against any damages arising out of the use of TI products in such safety-critical applications.

TI products are neither designed nor intended for use in military/aerospace applications or environments unless the TI products are specifically designated by TI as military-grade or "enhanced plastic." Only products designated by TI as military-grade meet military specifications. Buyers acknowledge and agree that any such use of TI products which TI has not designated as military-grade is solely at the Buyer's risk, and that they are solely responsible for compliance with all legal and regulatory requirements in connection with such use.

TI products are neither designed nor intended for use in automotive applications or environments unless the specific TI products are designated by TI as compliant with ISO/TS 16949 requirements. Buyers acknowledge and agree that, if they use any non-designated products in automotive applications, TI will not be responsible for any failure to meet such requirements.

Following are URLs where you can obtain information on other Texas Instruments products and application solutions:

### Products

Audio	<a href="http://www.ti.com/audio">www.ti.com/audio</a>
Amplifiers	<a href="http://amplifier.ti.com">amplifier.ti.com</a>
Data Converters	<a href="http://dataconverter.ti.com">dataconverter.ti.com</a>
DLP® Products	<a href="http://www.dlp.com">www.dlp.com</a>
DSP	<a href="http://dsp.ti.com">dsp.ti.com</a>
Clocks and Timers	<a href="http://www.ti.com/clocks">www.ti.com/clocks</a>
Interface	<a href="http://interface.ti.com">interface.ti.com</a>
Logic	<a href="http://logic.ti.com">logic.ti.com</a>
Power Mgmt	<a href="http://power.ti.com">power.ti.com</a>
Microcontrollers	<a href="http://microcontroller.ti.com">microcontroller.ti.com</a>
RFID	<a href="http://www.ti-rfid.com">www.ti-rfid.com</a>
RF/IF and ZigBee® Solutions	<a href="http://www.ti.com/lprf">www.ti.com/lprf</a>

### Applications

Communications and Telecom	<a href="http://www.ti.com/communications">www.ti.com/communications</a>
Computers and Peripherals	<a href="http://www.ti.com/computers">www.ti.com/computers</a>
Consumer Electronics	<a href="http://www.ti.com/consumer-apps">www.ti.com/consumer-apps</a>
Energy and Lighting	<a href="http://www.ti.com/energy">www.ti.com/energy</a>
Industrial	<a href="http://www.ti.com/industrial">www.ti.com/industrial</a>
Medical	<a href="http://www.ti.com/medical">www.ti.com/medical</a>
Security	<a href="http://www.ti.com/security">www.ti.com/security</a>
Space, Avionics and Defense	<a href="http://www.ti.com/space-avionics-defense">www.ti.com/space-avionics-defense</a>
Transportation and Automotive	<a href="http://www.ti.com/automotive">www.ti.com/automotive</a>
Video and Imaging	<a href="http://www.ti.com/video">www.ti.com/video</a>
Wireless	<a href="http://www.ti.com/wireless-apps">www.ti.com/wireless-apps</a>

TI E2E Community Home Page

[e2e.ti.com](http://e2e.ti.com)

Mailing Address: Texas Instruments, Post Office Box 655303, Dallas, Texas 75265  
Copyright © 2011, Texas Instruments Incorporated