

SECT B-B



P/N	R/C
U261-24XXN-4B0219	C(10nF/30V MIN)+Rp(56KΩ)
U261-24XXN-4B0226	C(10nF/30V MIN)

U261-24XXN-4B0219

C TYPE PLUG:

PCB:

- 1: Au
- 2: Ni

- 1: Au1u"
- 2: Au3u"
- 4: Au15u"
- 5: Au30u"

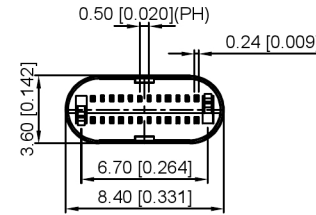
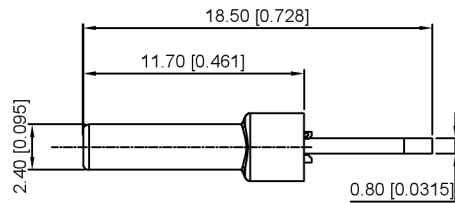
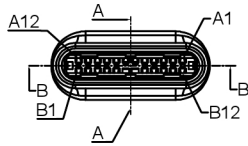
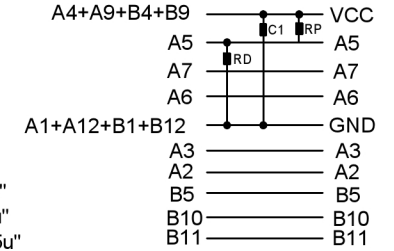

REMARKS:

1.CONTACT INSERTION AND WITHDRAW FORCE :

- 1.Insertion force : 5N-20N max.
2. Withdrawal force : 8N-20N.
- 3.Durability : 10000Cycles.

2.ELECTRIC PROPERTY :

- 1.Contact current rating : 3A.
- 2.Dielectric Strength : 100V AC(RMS).
- 3.Insulation Resistance : 100 megaohms min.
- 4.Contact resistance :
40m0hms MAX.FOR VBUS,GND AND OTHER CONTACT
50m0hms MAX.AFTER ENVIRONMENT TEST

3.AMBIENT TEMPERATURE :

- 1.Operating temperature : -55°C to +85°C.

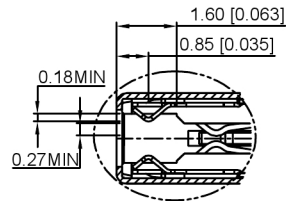
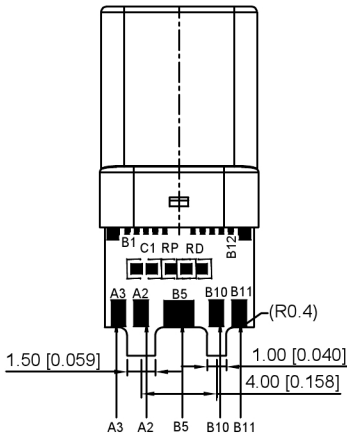

D
2: 1

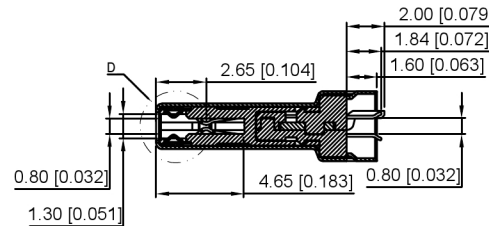

SECT A-A

A12	A11	A10	A9	A8	A7	A6	A5	A4	A3	A2	A1
GND	RX2+	RX2-	Vbus	SBU1	D-	D+	CC	Vbus	TX1-	TX1+	GND
GND	TX2+	TX2-	Vbus	Vconn			SBU2	Vbus	RX1-	RX1+	GND
B1	B2	B3	B4	B5	B6	B7	B8	B9	B10	B11	B12

6	Shrapnel	SUS T=0.10mm	
5	Shell	SUS T=0.15mm	Ovep-plating: Ni
4	Terminal	C7025 T=0.15mm	Ovep-plating: Au Ni/Sn
3	Latch	SUS T=0.4mm	
2	Housing	LCP	UL94-0
1	Housing Stopper	LCP	UL94-0
ITEM	DESCRIPTION	MATERIAL	REMARKS

DSND		SCALE: N/A	MODEL TYPE: Type-C 3.1	
DWN		VIEW:	PART NO.:	
CHKD		UNIT: mm/in	DWG NO.:	
APPD		SIZE: A4	U261-24XXN-4B0219	
		WEIGHT	SHEET	REVISION
			1/1	A0



XKB INDUSTRIAL PRECISION CO.,LIMITED

广东星坤科技股份有限公司

Δx		日期
生 Δx		
效 Δx		
MARK		DESCRIPTION

文件工程章

REVISIONS	DATE	REVISED	APPROVED	UNSPECIFIED TOLERANCES