

HEIDI-W

~30° wide beam optimized for LUXEON Rebel ES

TECHNICAL SPECIFICATIONS:

Dimensions	Ø 21.6 mm
Height	11.7 mm
Fastening	tape, pin
Colour	clear
Box size	480 x 280 x 300 mm
Box weight	11.1 kg
Quantity in Box	3264 pcs
ROHS compliant	yes ⓘ



MATERIAL SPECIFICATIONS:

Component	Type	Material	Colour
HEIDI-W	Single lens	PMMA	
HEIDI-TAPE	Tape	PU tape	black

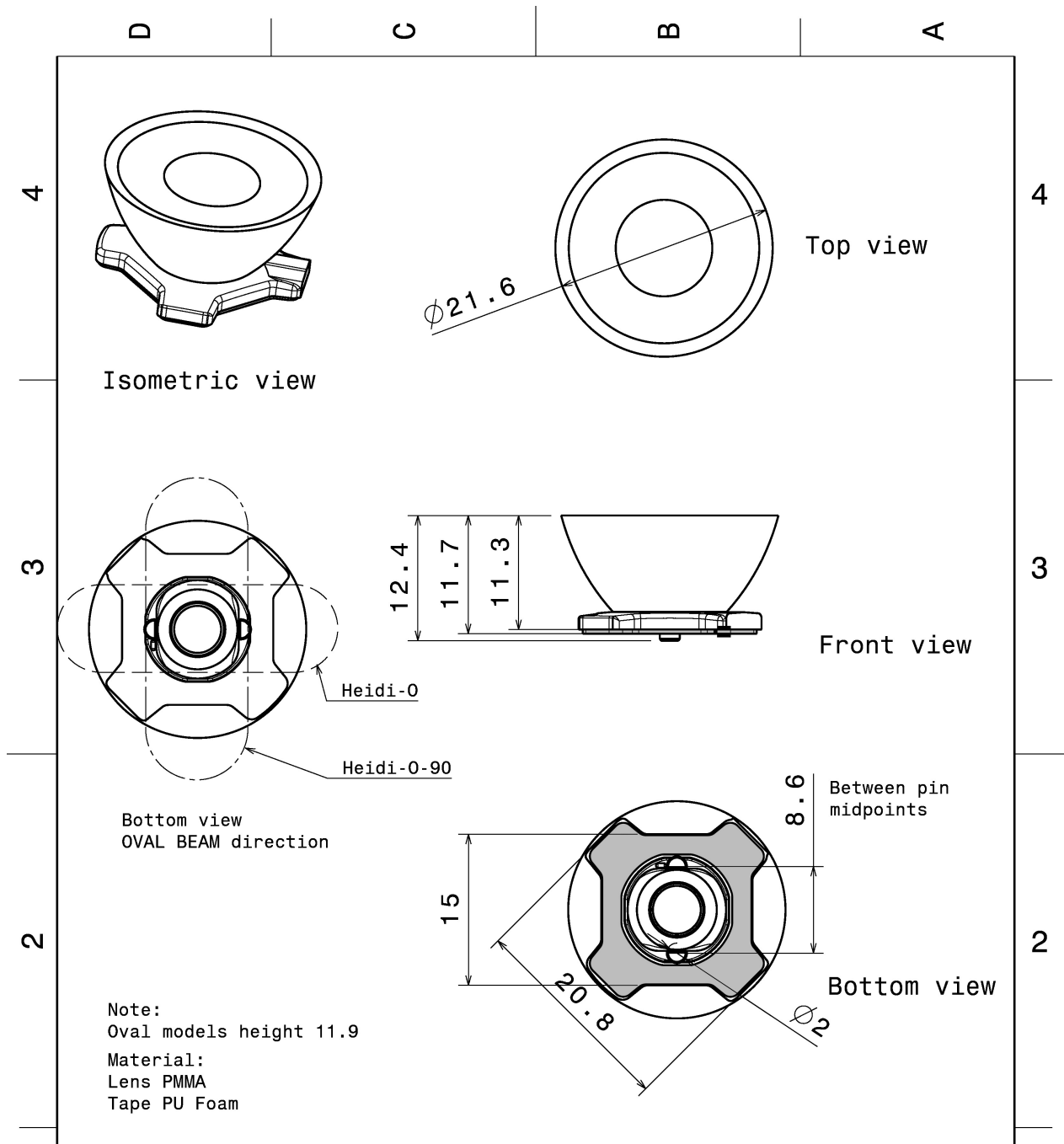

This drawing is our property. It can't be reproduced or communicated without our written agreement.		LEDiL		Ledil Oy Joensuunkatu 13 FIN-24100 SALO Finland	
DRAWING TITLE		Datasheet Heidi-Series Assy			
DRAWN BY ah	DATE 1.2.2012	SIZE A4	DRAWING NUMBER		REV 2
CHECKED BY	DATE	SCALE 2:1	WEIGHT (g)	SHEET 1/1	
DESIGNED BY	DATE				

PHOTOMETRIC DATA (MEASURED):

CREE 

LED XHP35 HD
 FWHM 32.0°
 Efficiency 84 %
 Peak intensity 2.410 cd/lm
 LEDs/each optic 1
 Light colour White
 Required components:

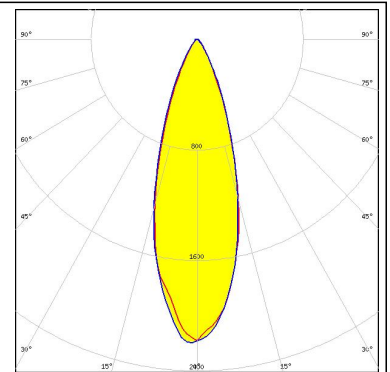

CREE 

LED XHP35 HI
 FWHM 31.0°
 Efficiency 94 %
 Peak intensity 2.700 cd/lm
 LEDs/each optic 1
 Light colour White
 Required components:

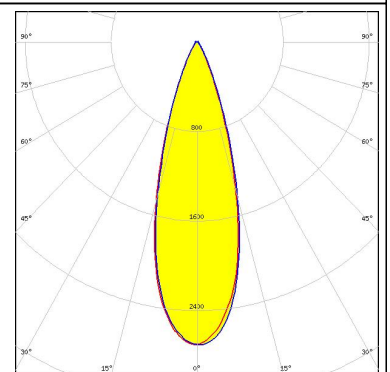
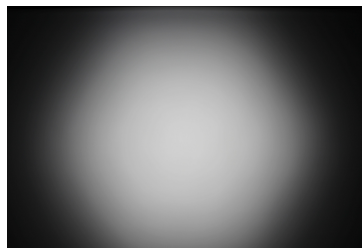

CREE 

LED XP-G3
 FWHM 32.0°
 Efficiency 94 %
 Peak intensity 2.500 cd/lm
 LEDs/each optic 1
 Light colour White
 Required components:

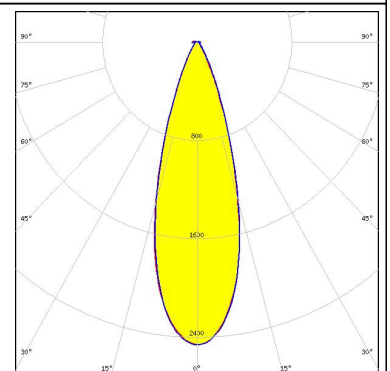
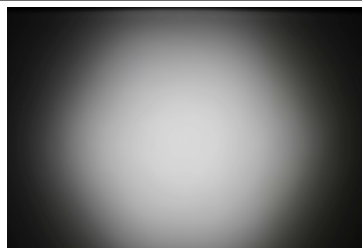

CREE 

LED XP-L HD
 FWHM 33.0°
 Efficiency 87 %
 Peak intensity 2.450 cd/lm
 LEDs/each optic 1
 Light colour White
 Required components:

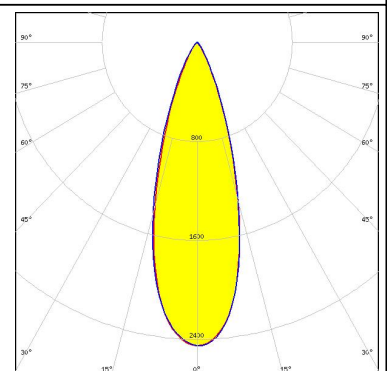
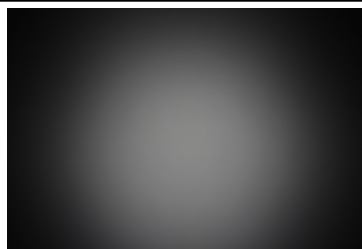

PHOTOMETRIC DATA (MEASURED):

LUMILEDS

LED LUXEON Rebel
 FWHM 32.0°
 Efficiency 87 %
 Peak intensity 2.800 cd/lm
 LEDs/each optic 1
 Light colour White
 Required components:

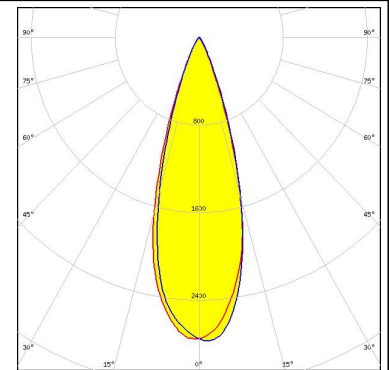
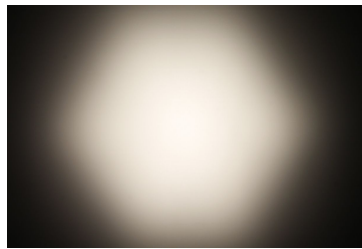

LUMILEDS

LED LUXEON Rebel ES
 FWHM 32.0°
 Efficiency 87 %
 Peak intensity 2.800 cd/lm
 LEDs/each optic 1
 Light colour White
 Required components:

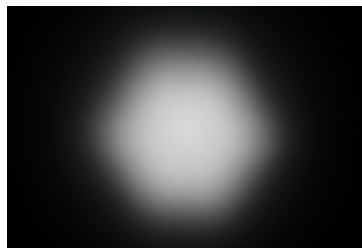

NICHIA

LED NVSW219D
 FWHM 32.0°
 Efficiency 94 %
 Peak intensity 2.600 cd/lm
 LEDs/each optic 1
 Light colour White
 Required components:

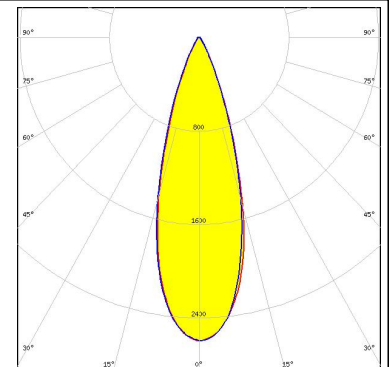

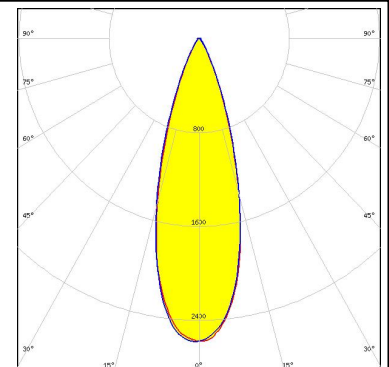
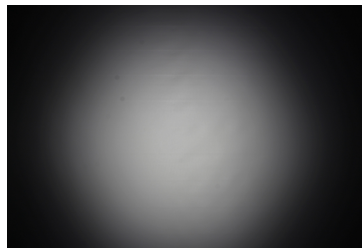

NICHIA

LED NVSW319B
 FWHM 32.0°
 Efficiency 94 %
 Peak intensity 2.600 cd/lm
 LEDs/each optic 1
 Light colour White
 Required components:

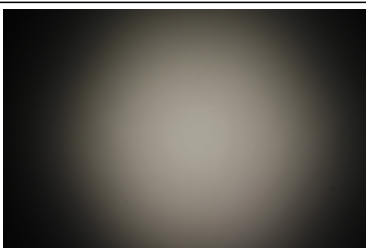
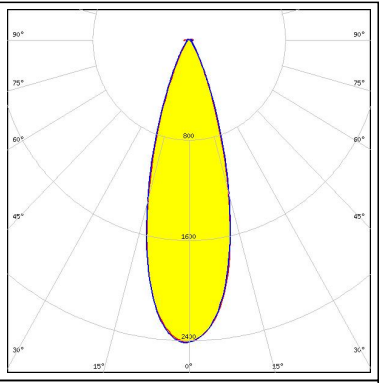
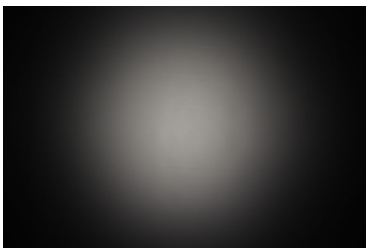
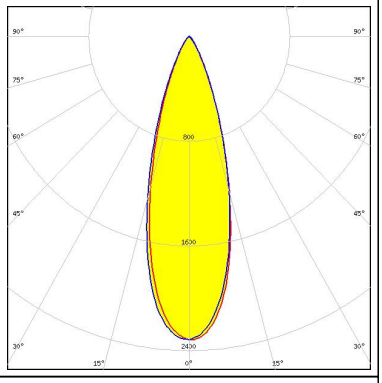

PHOTOMETRIC DATA (MEASURED):

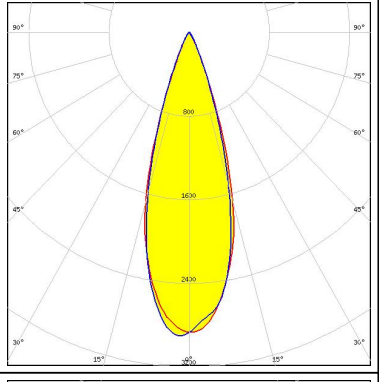
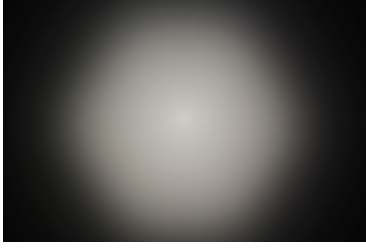
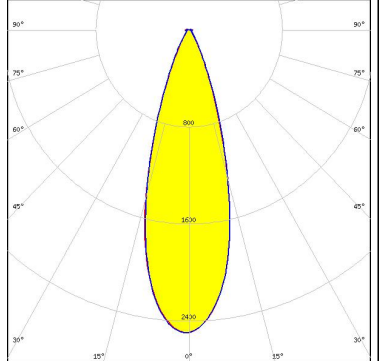
<p>NICHIA</p> <p>LED NVSW3x9A FWHM 31.0° Efficiency 90 % Peak intensity 2.400 cd/lm LEDs/each optic 1 Light colour White Required components:</p>		
<p>NICHIA</p> <p>LED NWSx229A FWHM 31.0° Efficiency 83 % Peak intensity 2.300 cd/lm LEDs/each optic 1 Light colour White Required components:</p>		
<p>OSRAM <small>Opto Semiconductors</small></p> <p>LED OSLON SSL 150 FWHM 32.0° Efficiency 86 % Peak intensity 2.900 cd/lm LEDs/each optic 1 Light colour White Required components:</p>		
<p>SEOUL SEMICONDUCTOR</p> <p>LED Z5M3 FWHM 32.0° Efficiency 94 % Peak intensity 2.500 cd/lm LEDs/each optic 1 Light colour White Required components:</p>		

PHOTOMETRIC DATA (MEASURED):



PHOTOMETRIC DATA (SIMULATED):



LED XP-G2 HE
FWHM 32.0°
Efficiency 93 %
Peak intensity 2.562 cd/lm
LEDs/each optic 1
Light colour White
Required components:

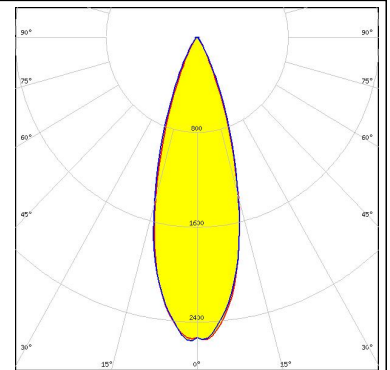

LED LUXEON A
FWHM 31.0°
Efficiency %
Peak intensity cd/lm
LEDs/each optic 1
Light colour White
Required components:



LED LUXEON IR Domed 150
FWHM 31.0°
Efficiency 93 %
Peak intensity 0.000 cd/lm
LEDs/each optic 1
Light colour White
Required components:



LED LUXEON IR Domed 90
FWHM 31.0°
Efficiency 94 %
Peak intensity 0.000 cd/lm
LEDs/each optic 1
Light colour White
Required components:

PHOTOMETRIC DATA (SIMULATED):

LUMILEDS

LED LUXEON R
 FWHM 32.0°
 Efficiency %
 Peak intensity cd/lm
 LEDs/each optic 1
 Light colour White
 Required components:

LUMILEDS

LED LUXEON SunPlus 20 Line (120 deg)
 FWHM 31.0°
 Efficiency 95 %
 Peak intensity 3.101 cd/lm
 LEDs/each optic 1
 Light colour White
 Required components:

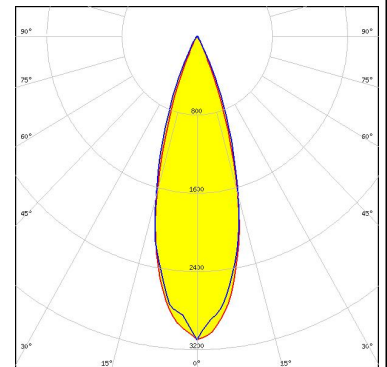

LUMILEDS

LED LUXEON SunPlus 20 Line (150 deg)
 FWHM 31.0°
 Efficiency 91 %
 Peak intensity 2.883 cd/lm
 LEDs/each optic 1
 Light colour White
 Required components:

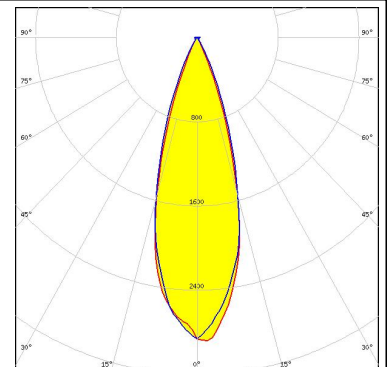

LUMILEDS

LED LUXEON SunPlus 20 Line (150 deg)
 FWHM 31.0°
 Efficiency 92 %
 Peak intensity 2.940 cd/lm
 LEDs/each optic 1
 Light colour White
 Required components:

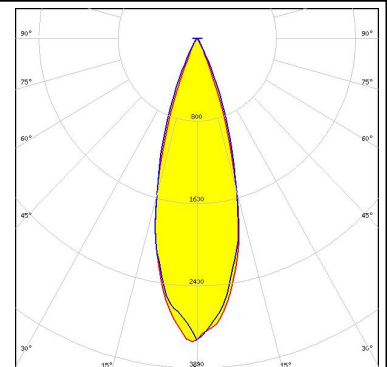

PHOTOMETRIC DATA (SIMULATED):



LED LUXEON SunPlus 35 Line
 FWHM 31.0°
 Efficiency 94 %
 Peak intensity 3.120 cd/lm
 LEDs/each optic 1
 Light colour White
 Required components:

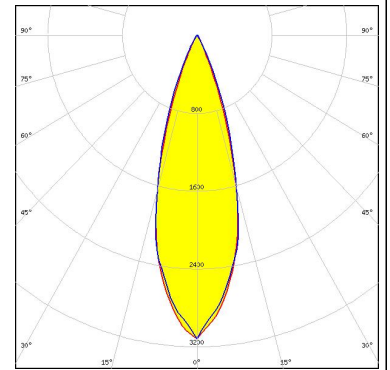

LED NV4WB35AM
 FWHM 32.0°
 Efficiency 92 %
 Peak intensity 2.544 cd/lm
 LEDs/each optic 1
 Light colour White
 Required components:

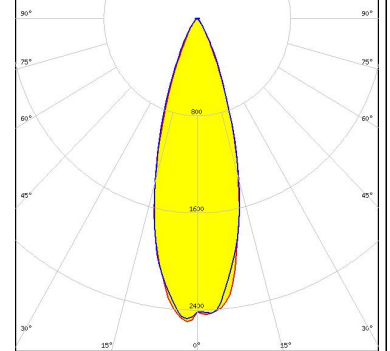

LED NVSxE21A
 FWHM 31.0°
 Efficiency 93 %
 Peak intensity 2.761 cd/lm
 LEDs/each optic 1
 Light colour White
 Required components:

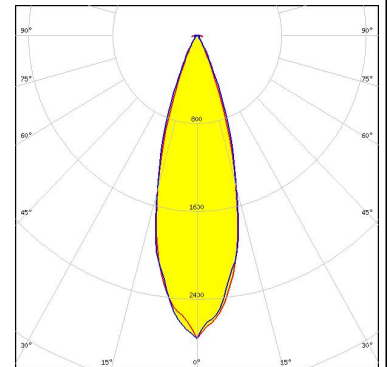

LED OSCONIQ P 3737 Flat
 FWHM 32.0°
 Efficiency 95 %
 Peak intensity 2.864 cd/lm
 LEDs/each optic 1
 Light colour White
 Required components:

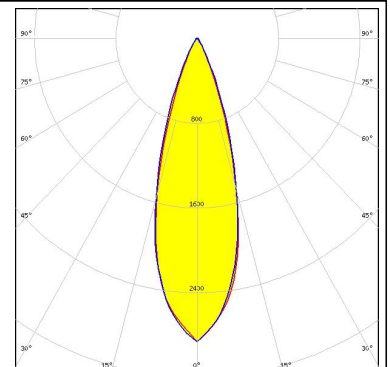

GENERAL INFORMATION:

NOTE: The typical beam angle will be changed by different color, chip size and chip position tolerance. The typical total beam angle is the full angle measured where the luminous intensity is half of the peak value.

MATERIALS:

As part of our continuous research and improvement processes, and to ensure the best possible quality and availability of our products, LEDiL reserves the right to change material grades without notice.

PRODUCT DATA USER AGREEMENT AND DISCLAIMER:

The measured data in the provided downloadable LEDiL Product Datasheets and Mechanical 2D-Drawings is rounded and provided as reference for planning. LEDiL Oy's optical specifications have been verified by conducting performance testing of the products in accordance with the company's quality system. The reported data are averaged results of multiple measurements with typical variation. LEDiL Oy reserves the right to without prior notification make changes and improvements to its products.

LEDiL Oy assumes neither warranty, nor guarantee nor any other liability of any kind for the contents and correctness of the provided data. The provided data has been generated with highest diligence but the provided data may in reality not represent the complete possible variation range of all intrinsic parameters. Therefore, in certain cases a deviation from the provided data could occur.

LEDiL Oy reserves the right to undertake technical changes of its products without further notification which could lead to changes in the provided data. LEDiL Oy assumes no liability of any kind for the possible deviation from any provided data or any other damage resulting from the usage of the provided data.

The user agrees to this disclaimer and user agreement with the download or usage of the provided files.

LEDiL Oy

Joensuunkatu 13
FI-24240 SALO
Finland

LEDiL Inc.

228 West Page Street
Suite D
Sycamore IL 60178
USA

Local sales and technical support

[www.ledil.com/
where_to_buy](http://www.ledil.com/where_to_buy)

Shipping locations

Salo, Finland
Hong Kong, China

Distribution Partners

[www.ledil.com/
where_to_buy](http://www.ledil.com/where_to_buy)