

Data sheet | Item number: 286-304

Relay module; Nominal input voltage: 24 VDC; 1 changeover contact;
Limiting continuous current: 7 A; Red status indicator; Module width: 15 mm

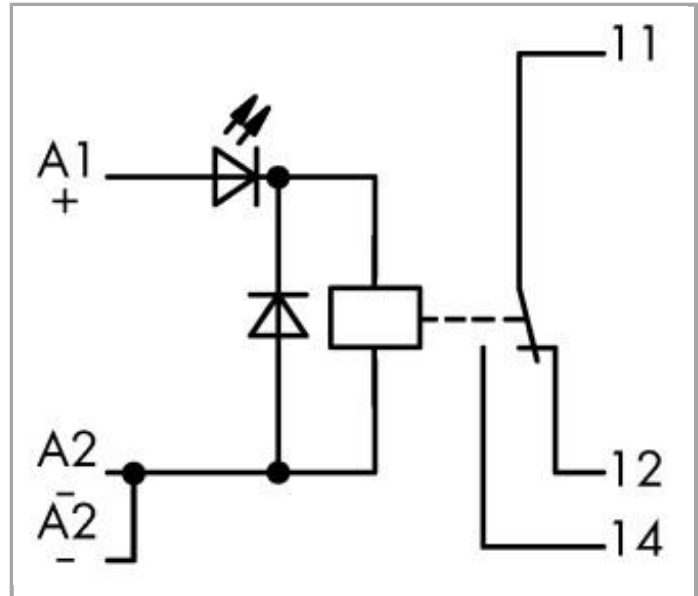

www.wago.com/286-304

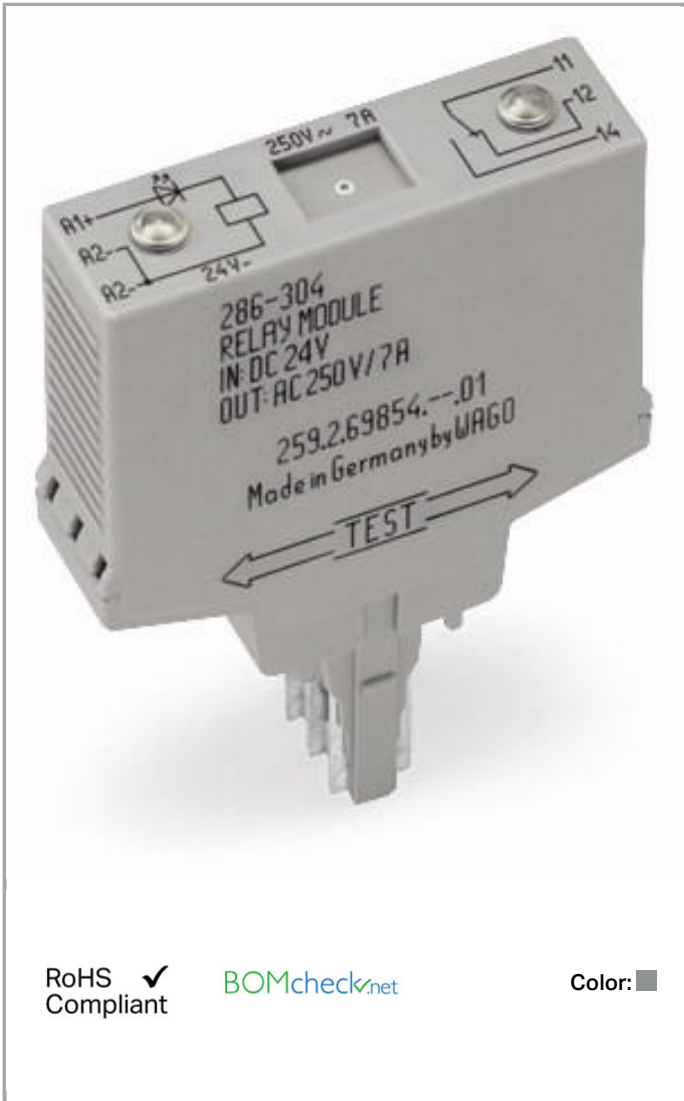

RoHS Compliant

[BOMcheck.net](https://www.bomcheck.net)

Color: ■

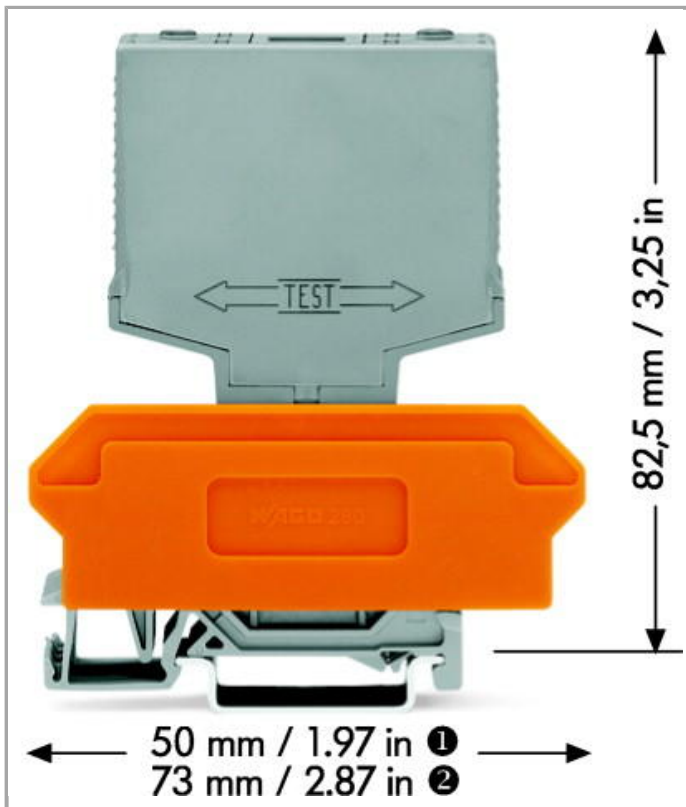

Data

Technical Data

Control circuit

Nominal input voltage U_N	24 VDC
Nominal input current at U_N	19.4 mA

Load circuit:

Number of changeover/switchover contacts	1
Contact material (relay)	AgNi 0.15
Limiting continuous current	7 A
Max. switching voltage	250 VAC
Max. switching power (resistive)	1750 VAAC
Pull-in time (typ.)	8 ms
Drop-out time (typ.)	6 ms
Bounce time (typ.)	4 ms
Electrical life (N.O.; resistive load; 23 °C)	100 x 10 ³ switching operations
Mechanical life (N.O.; resistive load; 23 °C)	30 x 10 ⁶ switching operations

Signaling

Status indication	LED red
-------------------	---------

Safety and protection:

Rated voltage	250 V
Rated impulse voltage	4 kV
Pollution degree	2
Dielectric strength, control/load circuit (AC, 1 min)	4 kV _{rms}
Dielectric strength, control/load circuit (AC, 1 min)	4 kV _{rms}
Dielectric strength open contact (AC, 1 min)	1 kV _{rms}
Dielectric strength open contact (AC, 1 min)	1 kV _{rms}
Degree of protection	IP20

Geometrical Data

Width	15 mm / 0.591 inch
Height from upper-edge of DIN-35 rail	82.5 mm / 3.248 inch
Depth	52 mm / 1.654 inch

Mechanical data

Type of mounting	Pluggable module for carrier terminal blocks
------------------	--

Material Data

Color	gray
Fire load	0.659 MJ
Weight	34.9 g

Environmental Requirements

Surrounding air (operating) temperature at U _N	-25 ... 40 °C
Pollution degree	2

Standards and specifications

Standards/specifications	EN 60664-1
--------------------------	------------

Commercial data









Country of origin	DE
GTIN	4045454319465

Product Group



6 (Interface Electronics)

Compatible products

Marking accessories

	Item no.: 209-701 WSB marking card; as card; not stretchable; plain; snap-on type	www.wago.com/209-701
	Item no.: 209-701/000-002 WSB marking card; as card; not stretchable; plain; snap-on type	www.wago.com/209-701/000-002
	Item no.: 209-701/000-005 WSB marking card; as card; not stretchable; plain; snap-on type	www.wago.com/209-701/000-005
	Item no.: 209-701/000-006 WSB marking card; as card; not stretchable; plain; snap-on type	www.wago.com/209-701/000-006
	Item no.: 209-701/000-007 WSB marking card; as card; not stretchable; plain; snap-on type	www.wago.com/209-701/000-007
	Item no.: 209-701/000-012 WSB marking card; as card; not stretchable; plain; snap-on type	www.wago.com/209-701/000-012
	Item no.: 209-701/000-017 WSB marking card; as card; not stretchable; plain; snap-on type	www.wago.com/209-701/000-017
	Item no.: 209-701/000-023 WSB marking card; as card; not stretchable; plain; snap-on type	www.wago.com/209-701/000-023
	Item no.: 209-701/000-024 WSB marking card; as card; not stretchable; plain; snap-on type	www.wago.com/209-701/000-024

General accessories

	Item no.: 280-609 Terminal block for pluggable modules; 12-pole; with 4-conductor terminal blocks; with orange separator; for DIN-rail 35 x 15 and 35 x 7.5; 2.5 mm ²	www.wago.com/280-609
	Item no.: 280-619 Terminal block for pluggable modules; 6-pole; with 2-conductor terminal blocks; with orange separator; for DIN-rail 35 x 15 and 35 x 7.5; 2.5 mm ²	www.wago.com/280-619
	Item no.: 280-763 Terminal block for pluggable modules; 12-pole; with 4-conductor terminal blocks; with marker carrier; with orange separator; for DIN-rail 35 x 15 and 35 x 7.5; 2.5 mm ²	www.wago.com/280-763

Downloads

Documentation



Additional Information

Disposal; Electrical and electronic equipment, Packaging	Oct 15, 2018	265.8 kB	Download
--	--------------	----------	----------

CAD files

CAD data

3D Download 286-304	URL	Download
---------------------	-----	----------

Subject to changes.

WAGO Corporation
Germantown, WI 53022
Phone: 1-800-DIN-RAIL (346-7245) | Fax: (262) 255-6222
Email: info.us@wago.com | Web: www.wago.com

Do you have any questions about our products?
We are always happy to take your call at {0}.