



General Description

MCP1702T series are a set of Low Dropout Linear Regulator ICs implemented in CMOS technology. They can withstand voltage 18V. And they are available with low voltage drop and low quiescent current, widely used in audio, video and communication appliances. 9V alkaline and one or two cell Li-Ion-powered, audio, video and communication appliances.

Features

- Low Power Consumption
- Low Voltage Drop
- Low Temperature Coefficient
- Withstanding Voltage 14V
- Quiescent Current 1.5 μ A
- Output Voltage Accuracy: tolerance \pm 2%
- High output current: 300mA

Application

- Battery-powered Equipments
- Communication Equipments
- Audio/Video Equipments
- Smart Battery Packs
- Smoke Detectors
- CO2 DETECTORS

Pin Configuration And Descriptions

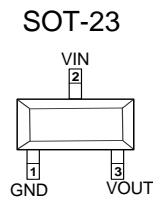
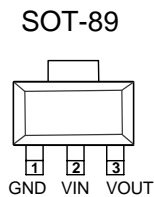

No.	Name	Functions Description
SOT-23/ SOT-89		
1	GND	Ground
2	V _{IN}	Input
3	V _{OUT}	Output

Order Information

Orderable Device	Package	Output Voltage	Packing Option
MCP1702T-xx02E/CB	SOT-23	2.5V,2.8V,3.0V,3.3V,5.0V	3000/Reel
MCP1702T-xx02E/MB	SOT-89	2.5V,2.8V,3.0V,3.3V,5.0V	1000/Reel

Note: xx is 25,28,30,33,50



Absolute Maximum Ratings

Description	Symbol	Value Range	Unit
Limit Power Voltage	V_{IN}	-0.3~+18	V
Storage Temperature Range	T_{STG}	-50~+125	°C
Operating Free-air Temperature Range	T_A	-40~+85	°C

Note: Stresses greater than those listed under “Absolute Maximum Ratings” cause permanent damage to the device. These are stress ratings only, and functional operation of the device at these or any other conditions beyond those indicated under “Recommended Operating Conditions” is not implied. Exposure to “Absolute Maximum Ratings” for extended periods may affect device reliability.

Heat Dissipation

Description	Symbol	Package	Value Range	Unit
Thermal resistance	θ_{JA}	SOT-89	200	°C/W
		SOT-23	500	°C/W
Power dissipation	P_W	SOT-89	500	mW
		SOT-23	200	mW

Block Diagram

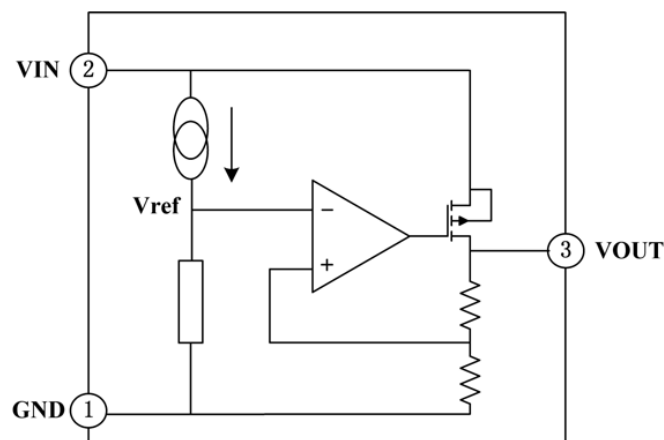



DC Characteristics (unless otherwise noted $T_A=25^\circ\text{C}$)

($V_{IN}=V_{OUT}+1.0\text{V}$, $C_{IN}=C_L=10\mu\text{F}$, $T_A=25^\circ\text{C}$, unless otherwise noted)

Parameter	Symbol	Test Condition	Min	Typ	Max	Unit
Output Voltage	V_{OUT}	$V_{IN}=V_{OUT}+1.0\text{V}$, $I_{OUT}=10\text{mA}$	2.5		5.0	V
Output Current	I_{OUT}	$V_{IN}=V_{OUT}+1.0\text{V}$	300			mA
Load Regulation	ΔV_{OUT}	$V_{IN}=V_{OUT}+1.0\text{V}$ $1\text{mA}\leq I_{OUT}\leq 300\text{mA}$		37	100	mV
Voltage Drop	V_{DIF}	$I_{OUT}=100\text{mA}$, $\Delta V_{OUT}=2\%$		195	300	mV
Quiescent Current	I_{SS}			1.5	3.0	μA
Line Regulation	$\frac{\Delta V_{OUT}}{V_{OUT}} \cdot \Delta V_{IN}$	$V_{OUT}+1.0\text{V}\leq V_{IN}\leq 6\text{V}$, $I_{OUT}=1\text{mA}$			0.2	%/V
Input Voltage	V_{IN}				14	V
Temperature Coefficient	$\frac{\Delta V_{OUT}}{\Delta T_A} \cdot V_{OUT}$	$V_{IN}=V_{OUT}+2.0\text{V}$, $I_{OUT}=10\text{mA}$, $-40^\circ\text{C}\leq T_A\leq 85^\circ\text{C}$		± 100		ppm/ $^\circ\text{C}$
Output Short Circuit Current	I_{lim}	$V_{OUT}=0\text{V}$		400		mA

Note: When $V_{IN}=V_{OUT}+1.0\text{V}$, as the output voltage declined 2%, the $V_{DIF}=V_{IN}-V_{OUT}$.

Function Description

MCP1702T series are linear voltage regulator ICs withstanding 18V voltage. The series IC consists of a voltage reference, an error amplifier, a current limiter and a phase compensation circuit plus a driver transistor. The output stabilization capacitor is also compatible with low ESR ceramic capacitors. The over current protection circuit and the over voltage protection circuit are built-in. The protection circuit will operate when the output current or input voltage reaches limit level.

Application Circuit

Basic Circuits

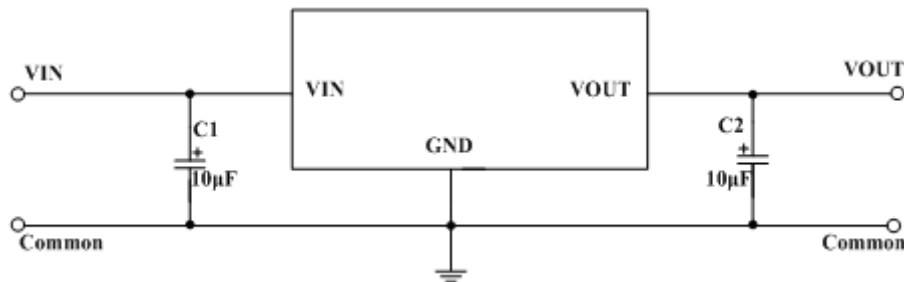



Package Dimensions
SOT-89

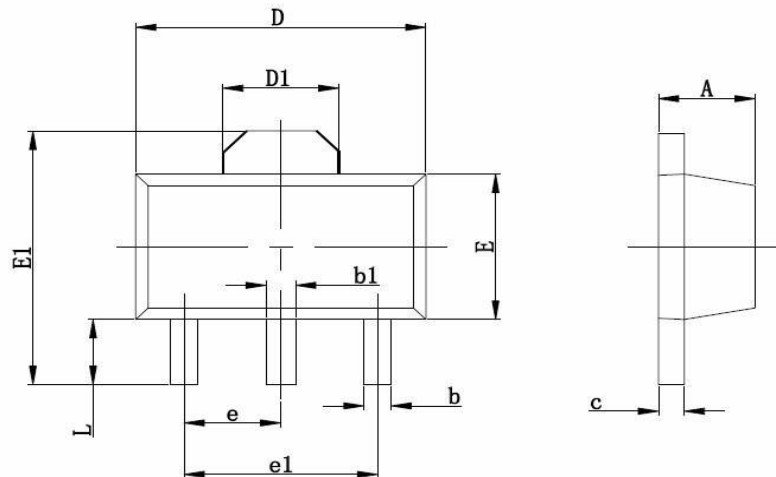

Symbol	Dimensions In Millimeters		Dimensions In Inches	
	Min	Max	Min	Max
A	1.400	1.600	0.055	0.063
b	0.320	0.520	0.013	0.020
b1	0.400	0.580	0.016	0.023
c	0.350	0.440	0.014	0.017
D	4.400	4.600	0.173	0.181
D1	1.550 REF.		0.061 REF.	
E	2.300	2.600	0.091	0.102
E1	3.940	4.250	0.155	0.167
e	1.500 TYP.		0.060 TYP.	
e1	3.000 TYP.		0.118 TYP.	
L	0.900	1.200	0.035	0.047



Package Dimensions
SOT-23

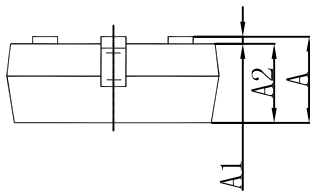
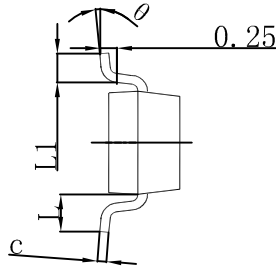
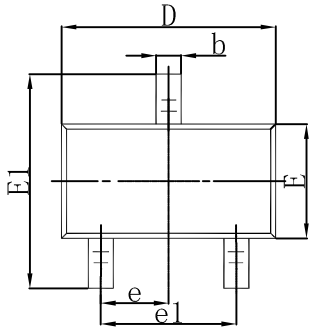

Symbol	Dimensions In Millimeters		Dimensions In Inches	
	Min	Max	Min	Max
A	0.900	1.150	0.035	0.045
A1	0.000	0.100	0.000	0.004
A2	0.900	1.050	0.035	0.041
b	0.300	0.500	0.012	0.020
c	0.080	0.150	0.003	0.006
D	2.800	3.000	0.110	0.118
E	1.200	1.400	0.047	0.055
E1	2.250	2.550	0.089	0.100
e	0.950 TYP		0.037 TYP	
e1	1.800	2.000	0.071	0.079
L	0.550 REF		0.022 REF	
L1	0.300	0.500	0.012	0.020
θ	0°	8°	0°	8°

Suggested Pad Layout

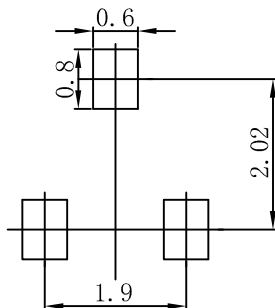

- Note:
1. Controlling dimension: in millimeters.
 2. General tolerance: $\pm 0.05\text{mm}$.
 3. The pad layout is for reference purposes only.



Attention

- Any and all HUA XUAN YANG ELECTRONICS products described or contained herein do not have specifications that can handle applications that require extremely high levels of reliability, such as life-support systems, aircraft's control systems, or other applications whose failure can be reasonably expected to result in serious physical and/or material damage. Consult with your HUA XUAN YANG ELECTRONICS representative nearest you before using any HUA XUAN YANG ELECTRONICS products described or contained herein in such applications.
- HUA XUAN YANG ELECTRONICS assumes no responsibility for equipment failures that result from using products at values that exceed, even momentarily, rated values (such as maximum ratings, operating condition ranges, or other parameters) listed in products specifications of any and all HUA XUAN YANG ELECTRONICS products described or contained herein.
- Specifications of any and all HUA XUAN YANG ELECTRONICS products described or contained herein stipulate the performance, characteristics, and functions of the described products in the independent state, and are not guarantees of the performance, characteristics, and functions of the described products as mounted in the customer's products or equipment. To verify symptoms and states that cannot be evaluated in an independent device, the customer should always evaluate and test devices mounted in the customer's products or equipment.
- HUA XUAN YANG ELECTRONICS CO.,LTD. strives to supply high-quality high-reliability products. However, any and all semiconductor products fail with some probability. It is possible that these probabilistic failures could give rise to accidents or events that could endanger human lives, that could give rise to smoke or fire, or that could cause damage to other property. When designing equipment, adopt safety measures so that these kinds of accidents or events cannot occur. Such measures include but are not limited to protective circuits and error prevention circuits for safe design, redundant design, and structural design.
- In the event that any or all HUA XUAN YANG ELECTRONICS products(including technical data, services) described or contained herein are controlled under any of applicable local export control laws and regulations, such products must not be exported without obtaining the export license from the authorities concerned in accordance with the above law.
- No part of this publication may be reproduced or transmitted in any form or by any means, electronic or mechanical, including photocopying and recording, or any information storage or retrieval system, or otherwise, without the prior written permission of HUA XUAN YANG ELECTRONICS CO.,LTD.
- Information (including circuit diagrams and circuit parameters) herein is for example only ; it is not guaranteed for volume production. HUA XUAN YANG ELECTRONICS believes information herein is accurate and reliable, but no guarantees are made or implied regarding its use or any infringements of intellectual property rights or other rights of third parties.
- Any and all information described or contained herein are subject to change without notice due to product/technology improvement, etc. When designing equipment, refer to the "Delivery Specification" for the HUA XUAN YANG ELECTRONICS product that you intend to use.