

### ● General Description

The AGM1010A2 combines advanced [Super Trench II](#) MOSFET technology with a low resistance package to provide extremely low  $R_{DS(ON)}$ .

This device is ideal for load switch and battery protection applications.

### ● Features

- Advance high cell density Trench technology
- Low  $R_{DS(ON)}$  to minimize conductive loss
- Low Gate Charge for fast switching
- Low Thermal resistance
- 100% Avalanche tested
- 100% DVDS tested

### ● Application

- MB/VGA Vcore
- SMPS 2<sup>nd</sup> Synchronous Rectifier
- POL application
- BLDC Motor driver

### Package Marking and Ordering Information

Device Marking	Device	Device Package	Reel Size	Tape width	Quantity
AGM1010A2	AGM1010A2	PDFN5*6	330mm	12mm	3000

**Table 1. Absolute Maximum Ratings (TC=25°C)**

Symbol	Parameter	Value	Unit
VDS	Drain-Source Voltage (VGS=0V)	100	V
VGS	Gate-Source Voltage (VDS=0V)	±20	V
ID	Drain Current-Continuous(Tc=25°C) <b>(Note 1)</b>	74	A
	Drain Current-Continuous(Tc=100°C)	45	A
IDM (pluse)	Drain Current-Pulsed <b>(Note 2)</b>	296	A
PD	Maximum Power Dissipation(Tc=25°C)	96	w
	Maximum Power Dissipation(Tc=100°C)	38	w
EAS	Avalanche energy <b>(Note 3)</b>	196	mJ
TJ,TSTG	Operating Junction and Storage Temperature Range	-55 To 150	°C

**Table 2. Thermal Characteristic**

Symbol	Parameter	Typ	Max	Unit
RθJA	Thermal Resistance Junction-ambient (Steady State) <sup>1</sup>	---	20	°C/W
RθJC	Thermal Resistance Junction-Case <sup>1</sup>	---	1.3	°C/W

### Product Summary

BVDSS	RDSON	ID
100V	7.8mΩ	74A

### PDFN5\*6 Pin Configuration

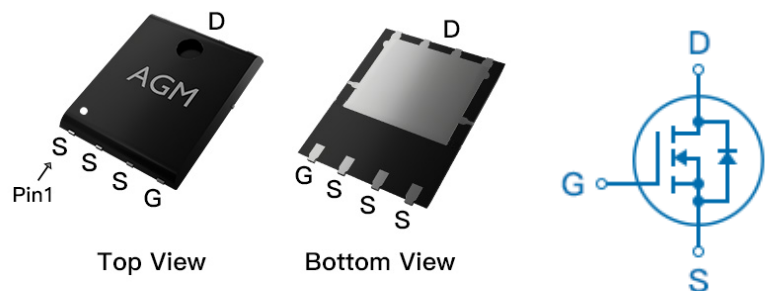

**Table 3. Electrical Characteristics (T<sub>J</sub>=25°C unless otherwise noted)**

Symbol	Parameter	Conditions	Min	Typ	Max	Unit
<b>On/Off States</b>						
BVDSS	Drain-Source Breakdown Voltage	V <sub>GS</sub> =0V ID=250μA	100	--	--	V
IDSS	Zero Gate Voltage Drain Current	V <sub>DS</sub> =100V,V <sub>GS</sub> =0V	--	--	1	μA
IGSS	Gate-Body Leakage Current	V <sub>GS</sub> =±20V,V <sub>DS</sub> =0V	--	--	±100	nA
V <sub>GS(th)</sub>	Gate Threshold Voltage	V <sub>DS</sub> =V <sub>GS</sub> ,ID=250μA	1.2	1.6	2.2	V
g <sub>FS</sub>	Forward Transconductance	V <sub>DS</sub> =5V,ID=15A	--	27	--	S
R <sub>DS(on)</sub>	Drain-Source On-State Resistance	V <sub>GS</sub> =10V, ID=20A	--	7.8	10	mΩ
		V <sub>GS</sub> =4.5V, ID=15A	--	10	13	mΩ
<b>Dynamic Characteristics</b>						
C <sub>iss</sub>	Input Capacitance	V <sub>DS</sub> =40V,V <sub>GS</sub> =0V, F=1MHZ	--	2433	--	pF
C <sub>oss</sub>	Output Capacitance		--	631	--	pF
C <sub>rss</sub>	Reverse Transfer Capacitance		--	27	--	pF
R <sub>g</sub>	Gate resistance	V <sub>GS</sub> =0V, V <sub>DS</sub> =0V,f=1.0MHz	--	1.4	--	Ω
<b>Switching Times</b>						
t <sub>d(on)</sub>	Turn-on Delay Time	V <sub>GS</sub> =10V,V <sub>DS</sub> =50V, ID=10A,R <sub>GEN</sub> =6Ω	--	10.9	--	nS
t <sub>r</sub>	Turn-on Rise Time		--	16	--	nS
t <sub>d(off)</sub>	Turn-Off Delay Time		--	40	--	nS
t <sub>f</sub>	Turn-Off Fall Time		--	26	--	nS
Q <sub>g</sub>	Total Gate Charge	V <sub>GS</sub> =10V, V <sub>DS</sub> =50V, ID=12A	--	26	--	nC
Q <sub>gs</sub>	Gate-Source Charge		--	10	--	nC
Q <sub>gd</sub>	Gate-Drain Charge		--	5.3	--	nC
<b>Source-Drain Diode Characteristics</b>						
I <sub>SD</sub>	Source-Drain Current(Body Diode)		--	--	74	A
V <sub>SD</sub>	Forward on Voltage	V <sub>GS</sub> =0V,IS=20A	--	--	1.2	V
t <sub>rr</sub>	Reverse Recovery Time	I <sub>F</sub> =20A , dI/dt=100A/μs , T <sub>J</sub> =25°C	--	50	--	ns
Q <sub>rr</sub>	Reverse Recovery Charge		--	70	--	nc

Notes 1.The maximum current rating is package limited.

Notes 2.Repetitive Rating: Pulse width limited by maximum junction temperature

Notes 3.EAS condition: T<sub>J</sub>=25°C,V<sub>DD</sub>=25V,V<sub>gs</sub>=10V,ID=28A,L=0.5mH,R<sub>G</sub>=25ohm

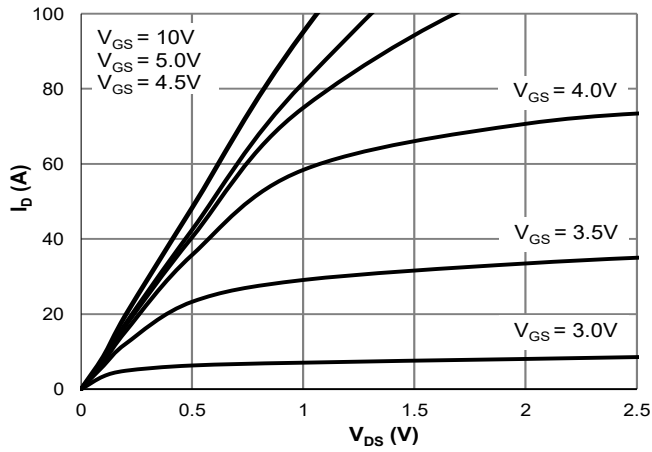
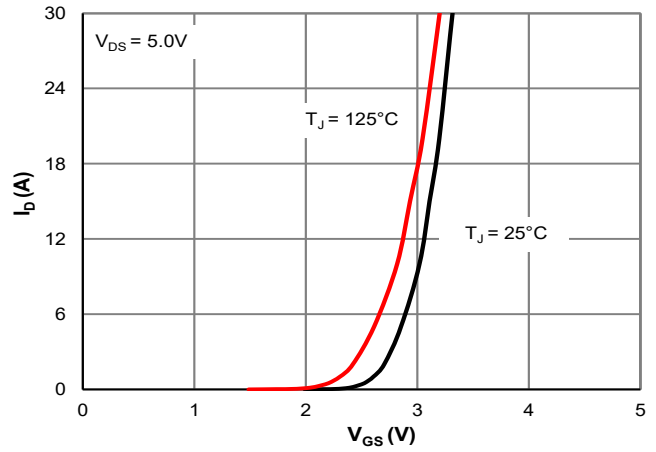
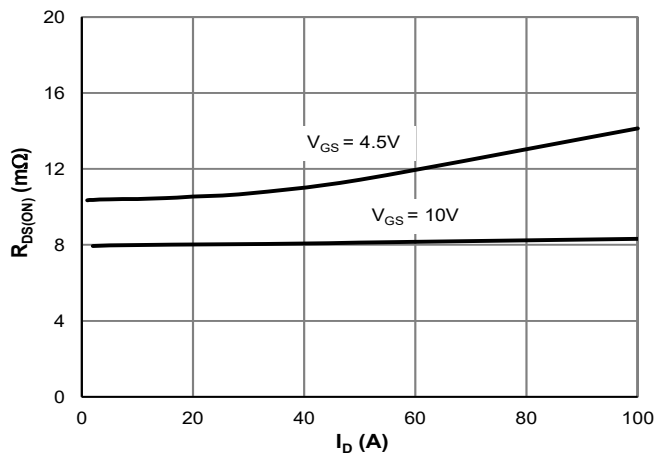
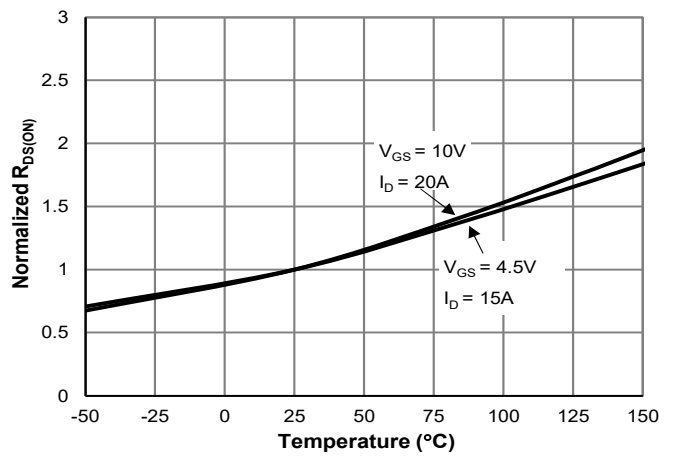
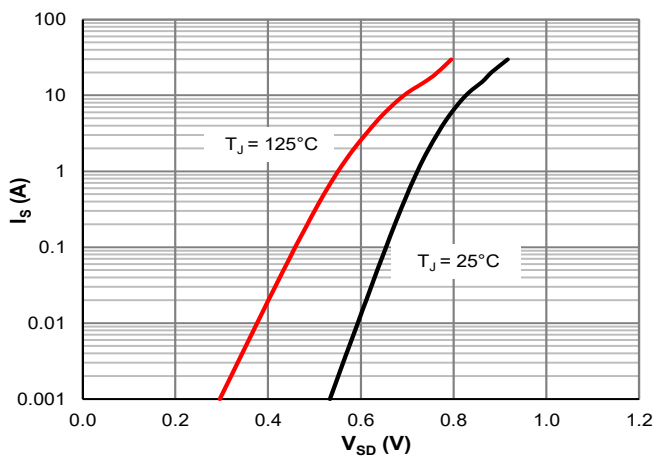
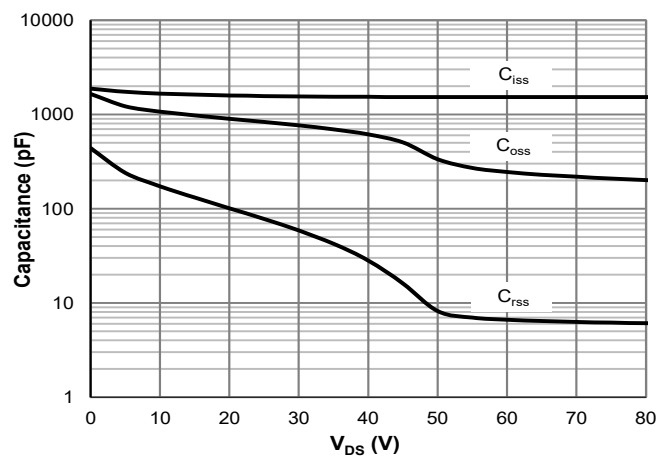
**Typical Electrical & Thermal Characteristics**

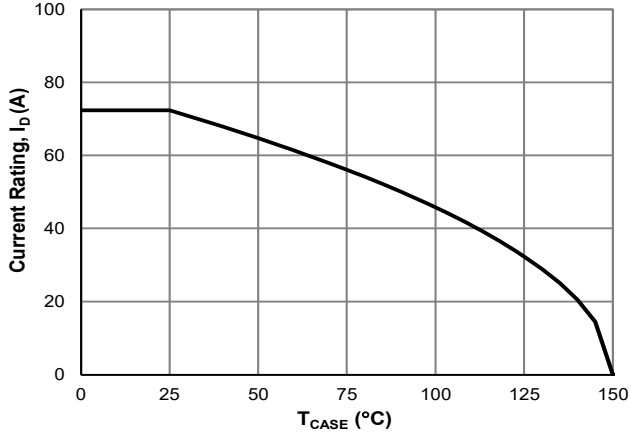
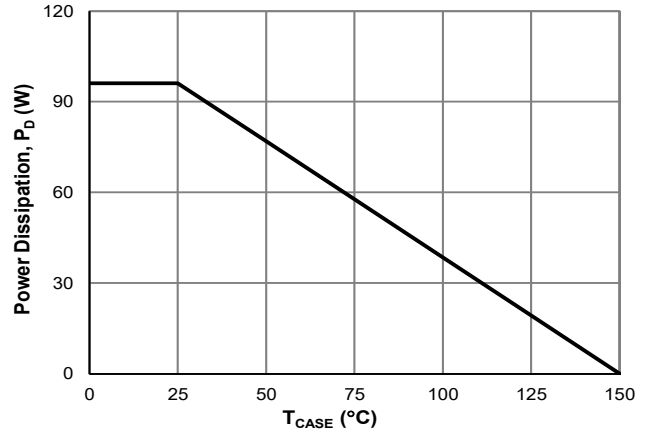
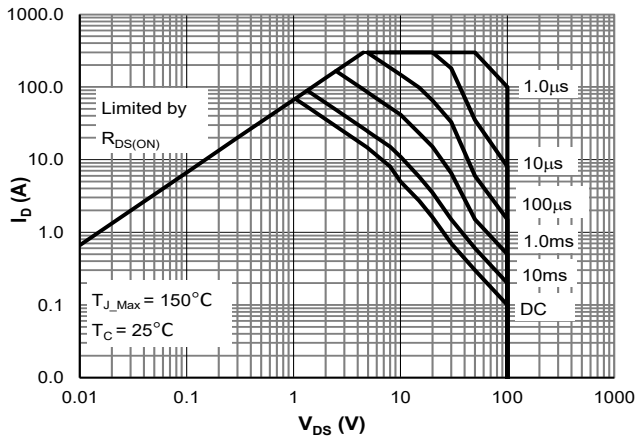
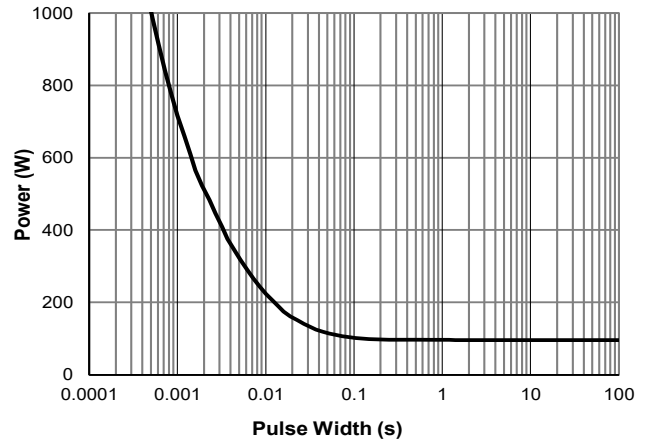
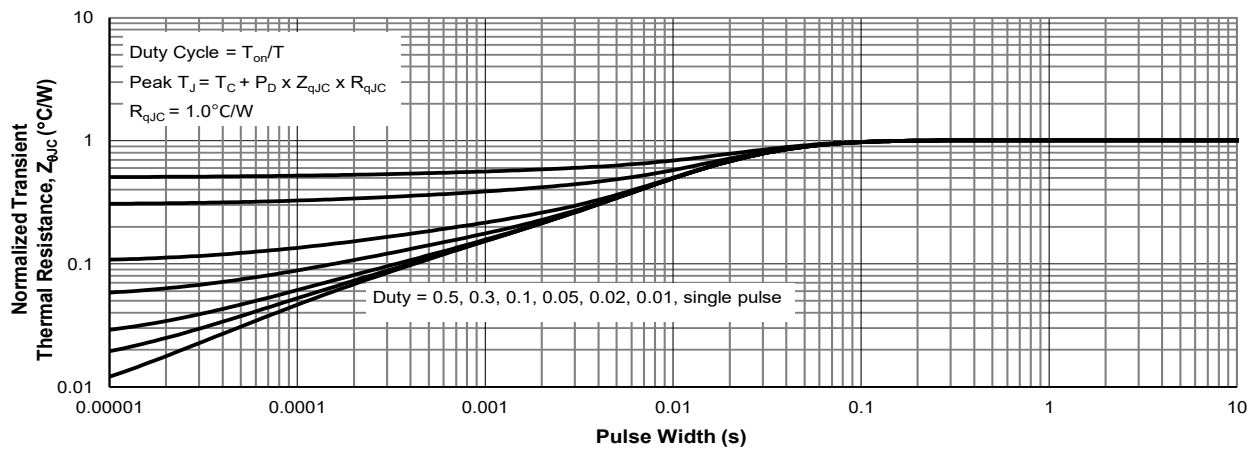
**Figure 1: Saturation Characteristics**

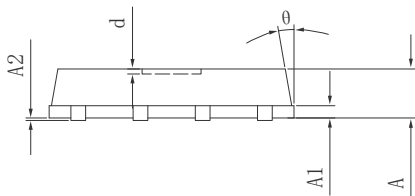
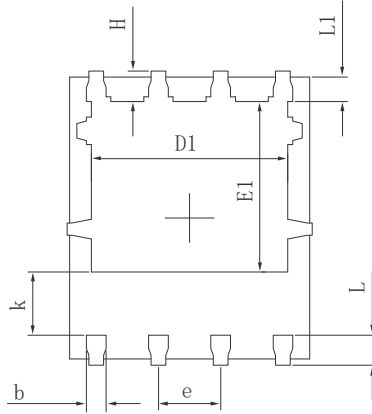
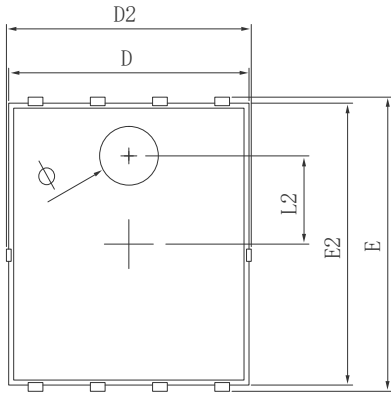
**Figure 2: Transfer Characteristics**

**Figure 3:  $R_{DS(ON)}$  vs. Drain Current**

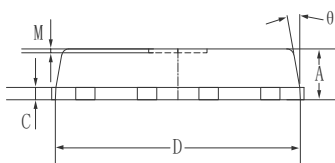
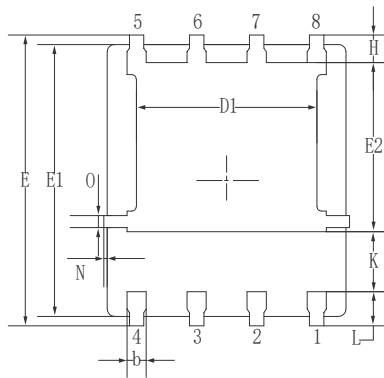
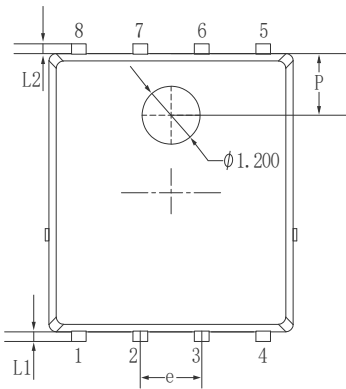
**Figure 4:  $R_{DS(ON)}$  vs. Junction Temperature**

**Figure 5: Body-Diode Characteristics**

**Figure 6: Capacitance Characteristics**

**Typical Electrical & Thermal Characteristics**

**Figure 7: Current De-rating**

**Figure 8: Power De-rating**

**Figure 9: Maximum Safe Operating Area**

**Figure 10: Single Pulse Power Rating, Junction-to-Case**

**Figure 11: Normalized Maximum Transient Thermal Impedance**

**•Dimensions (PDFN5\*6)**

SYMBOL	MILLIMETER		
	MIN.	TYP.	MAX.
A	0.900	1.000	1.100
A1	0.254 REF.		
A2	0~0.05		
D	4.824	4.900	4.976
D1	3.910	4.010	4.110
D2	4.924	5.000	5.076
E	5.924	6.000	6.076
E1	3.375	3.475	3.575
E2	5.674	5.750	5.826
b	0.350	0.400	0.450
e	1.270 TYP.		
L	0.534	0.610	0.686
L1	0.424	0.500	0.576
L2	1.800 REF.		
k	1.190	1.290	1.390
H	0.549	0.625	0.701
θ	8°	10°	12°
Φ	1.100	1.200	1.300
d			0.100



SYMBOL	MILLIMETER		
	MIN.	NOM.	MAX.
A	0.90	1.05	1.20
b	0.35	0.40	0.50
C	0.20	0.25	0.35
D	4.90	5.05	5.20
D1	3.72	3.82	3.92
E	6.00	6.15	6.30
E1	5.60	5.75	5.90
E2	3.47	3.57	3.67
e	1.27 BSC.		
H	0.48	0.58	0.68
K	1.17	1.27	1.37
L	0.64	0.74	0.84
L1/L2	0.20 REF.		
θ	8°	10°	12°
M	0.08 REF.		
N	0	-	0.15
O	0.25 REF.		
P	1.28 REF.		

## PDFN5\*6

## Marking Instructions:

## Model1:

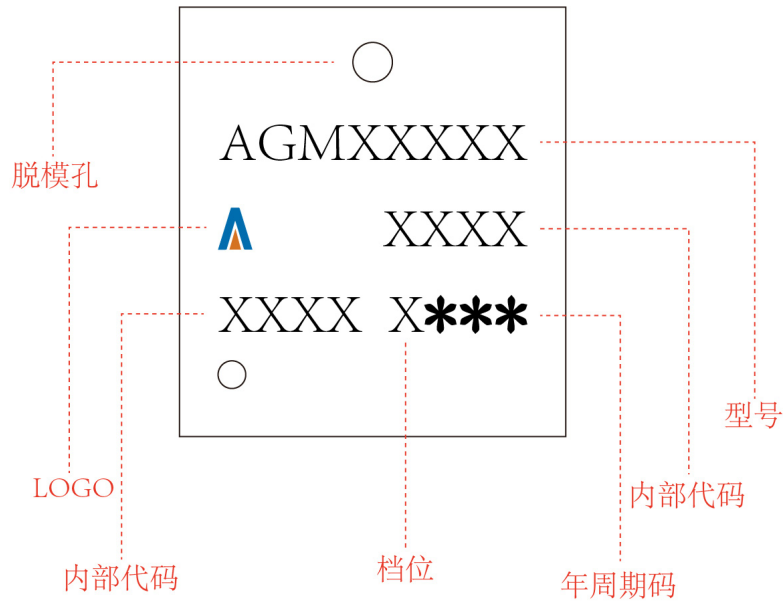

## Model2:

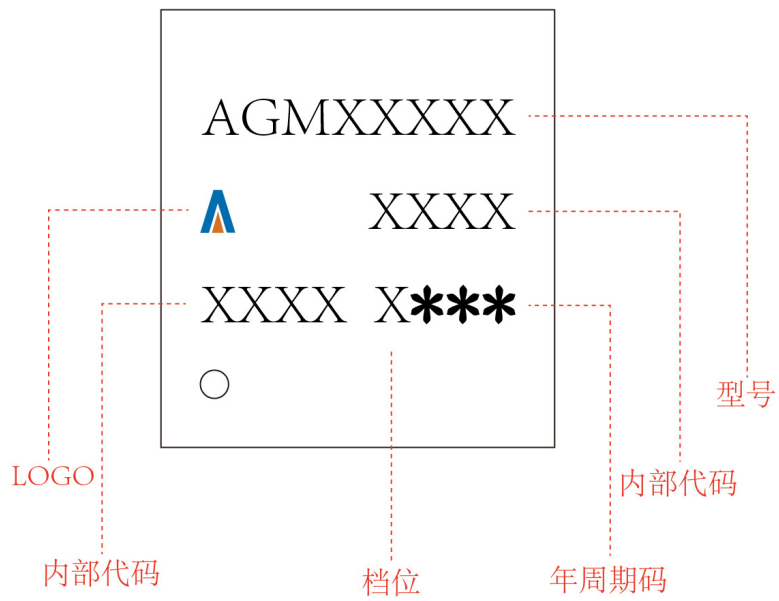

Disclaimer:

The information provided in this document is believed to be accurate and reliable. However, Shenzhen Core Control Source Electronics Technology Co., Ltd. does not assume any responsibility for the following consequences. Do not consider the use of such information or use beyond its scope.

The information mentioned in this document may be changed at any time without notice.

The products and information provided in this document do not infringe patents. Shenzhen Core Control Source Electronics Technology Co., Ltd. assumes no responsibility for any infringement of any other rights of third parties. The result of using such products and information.

This document is the sixth version issued on May 10th, 2025. This document replaces all previously provided information.

 It is a registered trademark of Shenzhen Core Control Source Electronics Technology Co., Ltd.

Copyright © 2017 Shenzhen Core Control Source Electronics Technology Co., Ltd. all rights reserved.