



## PSoC® & EZ- Color Development Tools Selector Guide For CY8C29x66, CY8C27x43, CY8C24x94, CY8C24x23A, CY8C21x34, CY8C21x23, CY20x34 and CY8CLEDxx

*A guide for development tool selection for Programmable System-on-Chip (PSoC) and EZ-Color designs*

Cypress Semiconductor has a Development Tool for every need – from entry-level evaluation and prototyping, to full-speed, real-time emulation and debugging; to programming in a high-volume manufacturing setting.

### Table of Contents

<b>SOFTWARE</b> .....	<b>2</b>
PSoC DESIGNER™ .....	2
PSoC EXPRESS™ .....	3
COMPILERS .....	3
<b>HARDWARE</b> .....	<b>5</b>
<b>DEVELOPMENT AND PROGRAMMING METHODS</b> .....	<b>6</b>
IN-CIRCUIT EMULATION.....	7
IN-SYSTEM SERIAL PROGRAMMING: OVERVIEW .....	8
IN-SYSTEM SERIAL PROGRAMMER (CY3207ISSP) .....	8
I <sup>2</sup> C-USB BRIDGE (CY3240-I2USB).....	9
<b>KITS</b> .....	<b>10</b>
DEMO/STARTER KITS .....	10
EVALUATION KITS.....	12
DEVELOPMENT KITS .....	16
PROGRAMMING KITS.....	18
KIT COMPONENTS & ACCESSORIES .....	20
FOOT & POD SELECTION GUIDE .....	20
ORDERING INFORMATION .....	22
FOOT / PACKAGE ADAPTERS .....	23
PROTOTYPING MODULES.....	25
<b>THIRD PARTY TOOLS</b> .....	<b>27</b>

## Software

Cypress's PSoC Mixed Signal Array comes with Windows-based software and hardware design tools. Fast, efficient, prototyping and design for embedded systems is now a reality. PSoC software is available at no cost. Download at <http://www.cypress.com>, and the hardware tools that suit your design needs from evaluation to prototyping and emulation are discussed in the following sections:

### PSoC Designer™

At the core of the PSoC development software suite is PSoC Designer. Utilized by thousands of PSoC developers, this robust software has been facilitating PSoC designs for half a decade at no cost to the developer. Download PSoC Designer here:

<http://www.cypress.com/psocdesigner>

System requirements: Pentium, equivalent or higher; at least 500MHz, Windows XP or Vista (32/64b); 512MB RAM, 250MB HDD space, Internet Explorer 6.0 (SP1).<sup>1</sup> Also recommended: USB port for programming your PSoC, and an Adobe Reader.

There are three subsystems within PSoC Designer:

- 1** *Device Editor*: Configure PSoC hardware blocks and IO, route internal signals, and define system parameters.
- 2** *Application Editor*: Write application code in 'C' or assembly language. (A fully integrated C compiler is accessible with the purchase of a license.)
- 3** *Debugger*: Use breakpoints, trace, watch variables, advanced dynamic event points and more.

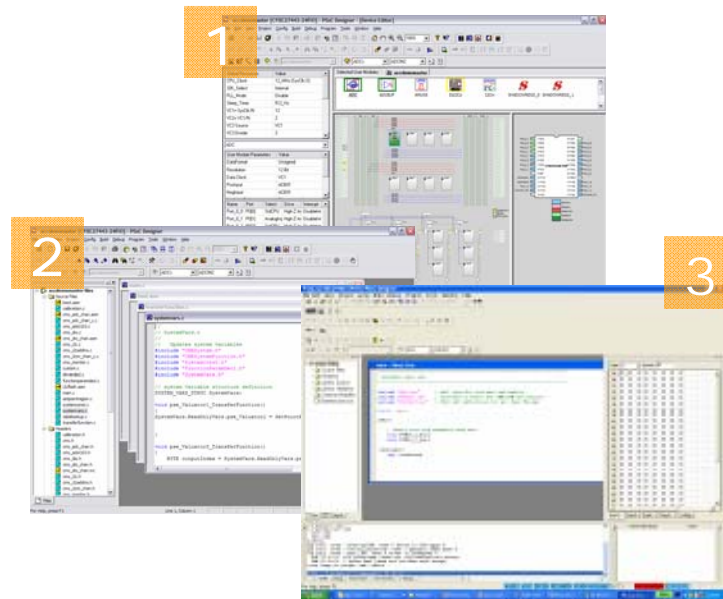

<sup>1</sup> The Cypress PSoC SW development tools make use of some portions of IE. Other browsers have not been tested.  
Page 2 of 28

## PSoC Express™

PSoC Express is the first visual embedded system design tool that allows a user to create an entire PSoC project and generate a schematic, BOM, and data sheet without writing a single line of code.

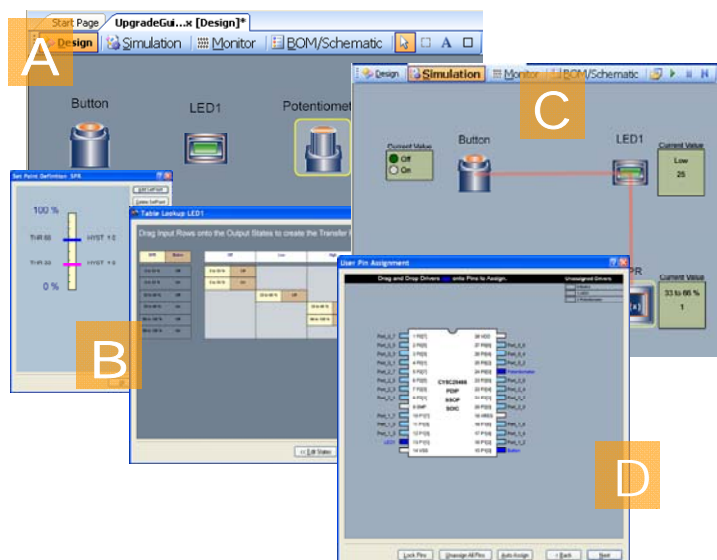

Users work directly with application objects such as LEDs, switches, sensors, and fans.

For more information and to download Express, please visit [www.cypress.com/express](http://www.cypress.com/express)

- A** Select inputs and outputs
- B** Define the output's behavior
- C** Simulate the design to verify
- D** Build to generate PSoC HEX file, BOM, schematic, and custom data sheets of your design  
Optimize your design with monitoring and tuning functions

## Compilers

Currently there are two C compilers offered with PSoC Designer™:

IMAGEcraft™	HI-TECH™ C PRO for PSoC Mixed Signal Arrays
<ul style="list-style-type: none"> <li>• ANSI C compiler</li> <li>• Inline assembly and interface with assembly modules</li> <li>• Modern stack-based architecture</li> <li>• 7 basic data types including IEEE 32-bit floating point</li> <li>• Assembler and linker</li> <li>• Math and string libraries</li> <li>• 'C' interrupt service routines</li> <li>• Librarian</li> </ul> <p>Price: \$145 (MSRP) <a href="http://www.cypress.com/go/imagecraft">www.cypress.com/go/imagecraft</a></p>	<ul style="list-style-type: none"> <li>• ANSI C compiler</li> <li>• Eliminates the need for many non-standard C qualifiers and compiler options</li> <li>• Automatically analyzes user assembly and object code files as a whole, with <i>Omniscient Code Generation™</i> technology</li> <li>• Memory banking without requiring special qualifiers for better performance</li> <li>• Optimizes the size of each pointer variable</li> <li>• Eliminates contention for the PSoC index register</li> <li>• Produces more efficient interrupt context switching code</li> <li>• Customizes the functionality of the printf library function for maximum efficiency</li> <li>• Delivers Denser Code For Better Performance - Up to 50% more compact code than others!</li> </ul> <p>Price: \$1495 (MSRP) <a href="http://www.cypress.com/hitech">www.cypress.com/hitech</a></p>

## PSoC Programmer

PSoC Programmer is a programming application that helps to deliver host-resident application code to the target via a hardware programming tool. Flexible enough to be used on the bench in development, yet suitable for factory programming, PSoC Programmer works as a standalone programming application or it can operate directly from PSoC Designer™ or PSoC Express™.

PSoC Programmer is the one-stop programming application for Cypress PSoC development tools.

<http://www.cypress.com/psocprogrammer>

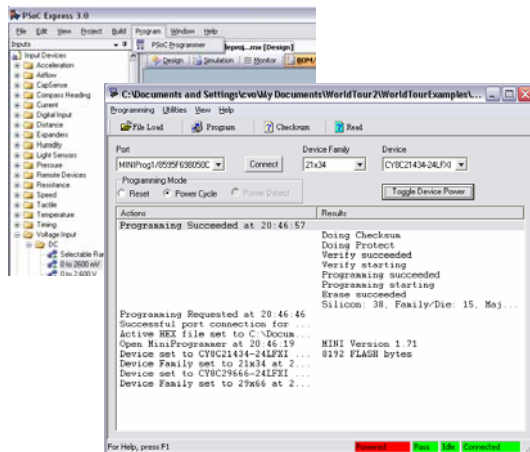

## Hardware

This section introduces the major categories of hardware Cypress offers for development with PSoC.

The hardware development for Cypress PSoC falls into five major categories: Demo/Starter Kits, Evaluation Kits, Development Kits, Reference Design Kits, and Programming Kits. Cypress Semiconductor also offers individual Accessories/Kit Components:

- **Demo/Starter Kits:** Proof-of-Concept demonstration of technology and potential application. Starter kits offer cost-effective evaluation of PSoC Technology. Code and hardware are provided for concept feasibility.
- **Evaluation Kits:** Technology evaluation and training tools to provide the end user with a basic level of understanding on how the technology works and can be employed.
- **Development Kits:** A full-featured platform with hardware and software intended to support the design effort from concept to verification.
- **Programming Kits:** Programming tools for the PSoC and in-circuit emulation; often bundled with an evaluation board. A programming hardware tool is required for loading your program to the PSoC device, and for debugging on the target. Models range in purpose from programming a device on your desk to heavier duty programmers for use in a production environment.
- **Kit Components & Accessories:** Replacement parts, adaptors, special function daughter modules, and more.

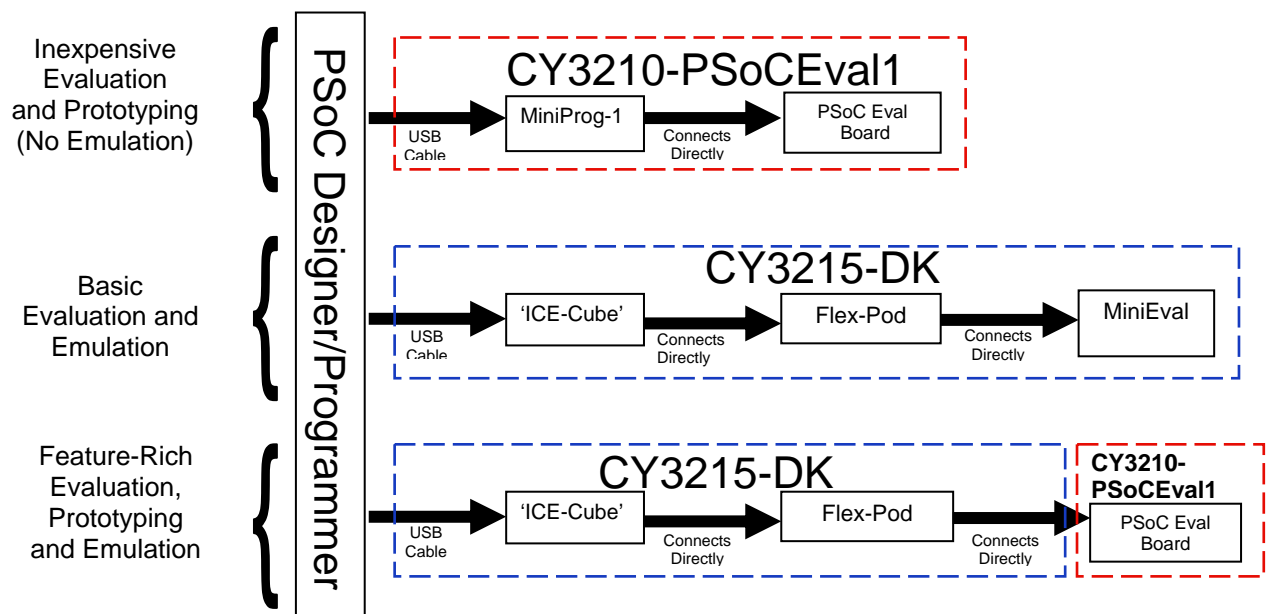

Note: The "ICE-Cube" unit for in-circuit emulation is not available for purchase except as a kit (CY3215-DK.)

## Development and Programming Methods

Currently there are four ways to program a PSoC:

- Prototype programming
- Full-featured in-circuit emulation
- Production programming
- Cypress factory programming for high volume orders\*\*

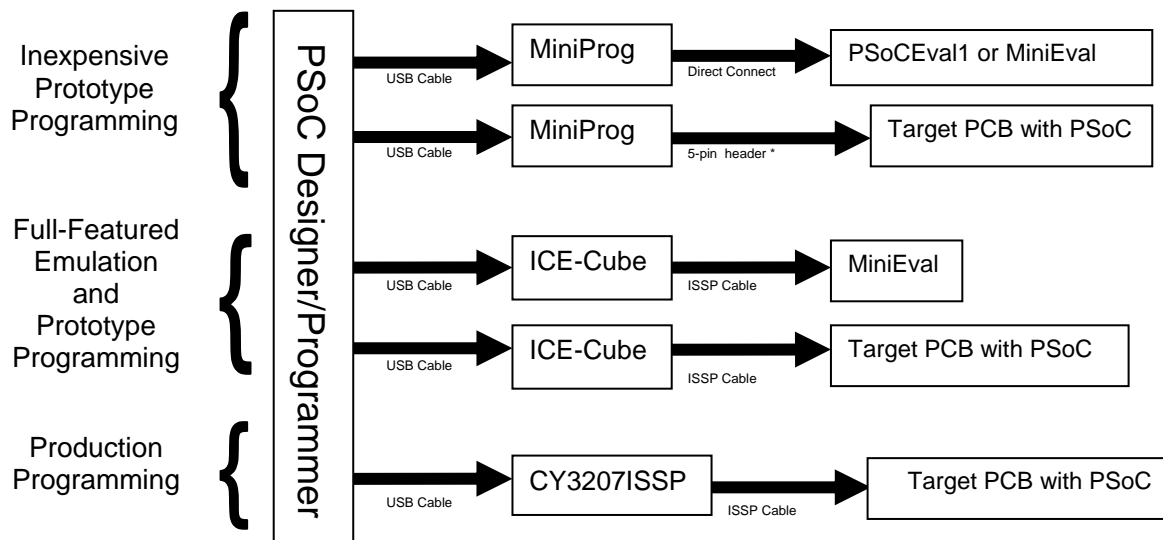

\* This friction-lock 5-pin header that connects target PCB to Miniprogram can be ordered as DigiKey WM4203-ND.

\*\* Factory programming of a PSoC device by Cypress Semiconductor requires a contract with a minimum order of 100Ku parts per year. Please contact your local Cypress sales office for more information.

The following diagram demonstrates one example of a set-up to program a specific PSoC device from a host PC through a USB cable to the ICE, which connects via Flexcable to the POD, which may be seated with a package adaptor (foot) and a PSoC device on a board. These are all the pieces you would need to implement in-circuit emulation.

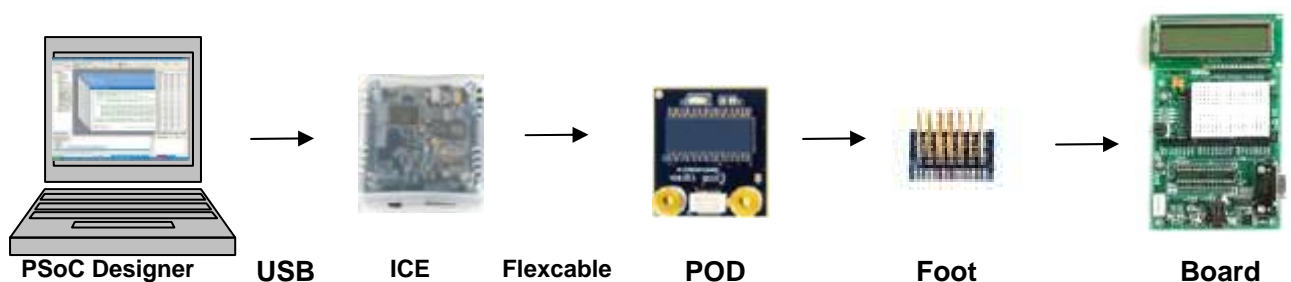

In the above example, the devices could be described as the following:

- QFN Emulation Kit: 1 Flexcable, 1 QFN-type Pod, 2 Feet (for flat-pack style pkgs)
- Non-QFN Emulation Kit: 1 Flexcable, 1 Pod, 2 Feet (all other chip packages)
- POD: Two types of emulation Pods exist: for QFN and non-QFN PSoC packages.
- FOOT: Quantity of 4 PSoC device package adapters (FEET)
- Flexcable Kit: 1 Flexible Cable

The POD seats a PSoC chip for emulation, and the Foot is a package adapter. You can choose a POD and Foot for your chosen PSoC device/package from the table in the appendix. You may want to order extra feet even if the default feet in your emulator kit (PDIP/QFN) match the package type of your particular PSoC part number.

## In-Circuit Emulation with PSoC

The In-circuit Emulator (ICE) is driven by the Debugger in PSoC Designer™. The software interface of the debugger allows the user to run, halt, and single-step the processor with the ICE. It also allows the user to set complex event points. Event points can start and stop the trace memory on the ICE, as well as break the program execution.

The ICE can also serve as a single-site device programmer via an ISSP Cable and the MiniEval board included in the CY3215-DK kit. The ICE supports large memory model PSoC devices (devices with >256 bytes of RAM) and is backward compatible with previous PSoC devices (CY8C27x43 and CY8C24x23A).

*What adapters do you need for your project?*

In addition to the ICE that is included in the Development Kit (CY3215-DK), different Emulation Pods are available to support the range of packages available in the PSoC family. The PODs plug into (or are soldered onto) the user's circuit board to provide the physical interface to the ICE/ PSoC Device. PODs are available for low-cost expansion of ICE-Cube capability as a modular system.

The ICE can only be purchased as a kit: CY3215-DK. In addition, if you are using QFN packages an Emulation Kit (CY3250-xxxx-QFN) must be purchased for adapting the specific package to the POD. The package you choose can be adapted to any POD with a "Foot," or package adapter. Detailed selection guides follow in the appendix.

Each PSoC family has two pod kits associated with it: QFN and Non-QFN, and each type of package offered in that family has one foot Kit for use with that package type.

The following photos demonstrate the connection between the parts:

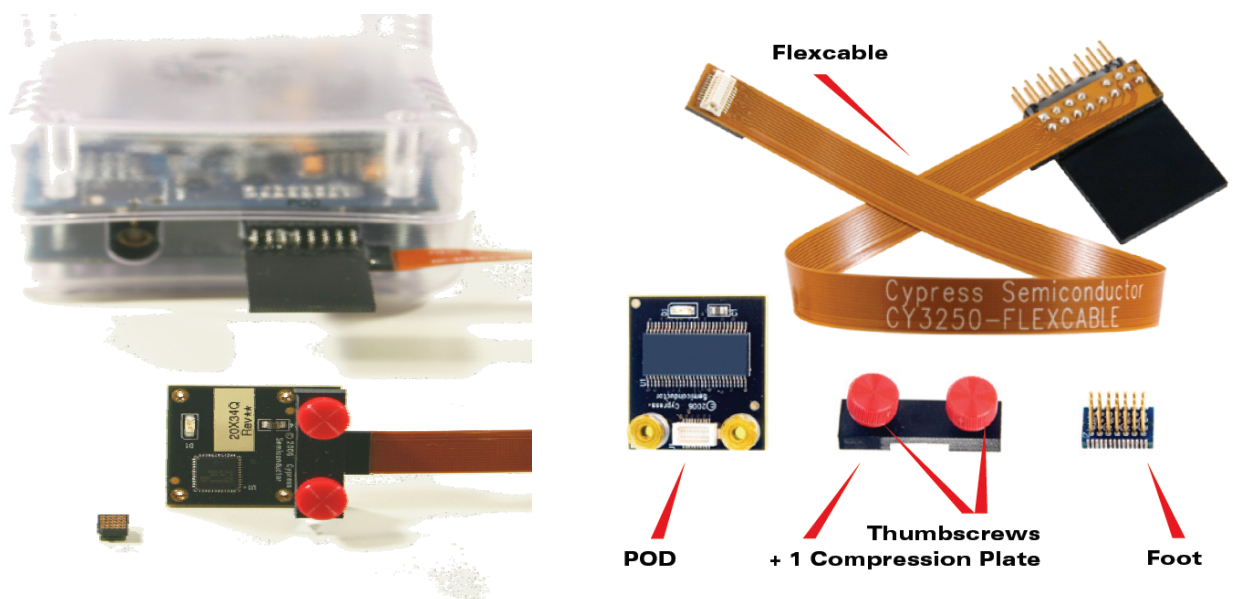

## In-System Serial Programming

The CY3207ISSP, ICE (CY3215-DK), and MiniProg1 (CY3210-MiniProg1) all allow easy In-System Serial Programming (ISSP). A cable is included in the ISSP Development Kit (CY3207ISSP.) All designers are encouraged to include ISSP capability on their printed circuit boards (PCBs.)

ISSP is perfect for prototyping because it allows rapid reprogramming of the PSoC part mounted on the PCB and eliminates the need for multiple package-specific programmers. ISSP can also be useful in production programming because it eliminates the need for programming individual chips prior to PCB assembly.



Pictured to the right is an ICE-Cube connected directly to a project PCB (the CY3210-PSoCEval1). ISSP can be done with the small ISSP connector. An ISSP connector is pictured to the left. See Application Notes AN2014 and AN2026,

AN2026a, AN2026b for detailed information on ISSP.



## In-System Serial Programmer (CY3207ISSP)

The CY3207ISSP is a production-unit programmer. It includes protection circuitry and an industrial case that is more robust than the MiniProg and the ICE for a production-programming environment. The CY3207ISSP can program parts in-system via serial connection, or mounted in the socket on the CY3207ISSP. Use the table to the right to identify the correct programming adapter for CY3207ISSP socket programming. This adapter information is also available at [www.emulation.com](http://www.emulation.com)



PSoC Foot Print	Programming Adapter P/N by Emulation Technologies
8-Pin SOIC	AS-08-08-01S-3
16-Pin SOIC	AS-16-16-02S-3
20-Pin SOIC	AS-20-20-01S-3-GANG
28-Pin SOIC	AS-28-28-02S-3
20-Pin SSOP	AS-20-20-01SS-3
24-Pin QFN	AS-24-28-01ML-6
28-Pin SSOP	AS-28-28-02SS-6ENP-GANG
32-Pin QFN	AS-32-28-03ML-6
44-Pin QFN	AS-44-28-03Q-6
48-Pin QFN	AS-48-28-02ML-6
48-Pin SSOP	AS-48-48-01SS-6-GANG
56-Pin QFN	AS-56-28-01ML-6
100-Pin TQFP	AS-100-28-01TQ-6

## Prototyping Modules (CY3210-2xxxx)

PSoC Prototyping Modules are 28-pin PDIP adapters that seamlessly connect any PSoC device package-type to the 28-pin PDIP connector that is default on Cypress PSoC kits. Check the selection tables in the *Kit Components and Accessories* section of this document for a list of Prototyping Modules offered by Cypress. (Note: Prototyping Modules may sometimes be referred to as Evaluation PODs.)

Prototyping Modules offer quick and easy prototyping of any PSoC device and package on a board with just a 600-mil 28-Pin ZIF socket (included in many of our kits, and easy for a user to acquire and build on their own.)

Prototyping Modules feature:

- 28-pin DIP footprint (0.6 in width). Fits in a ZIF socket or breadboard
- ISSP programming header enables programming via ISSP
- Connector for CAT5 cable connection to the ICE-cube
- Port pin-out for 28 pins on bottom of the pod matches port pin-outs for the 28 pin PDIP PSoC
- Pins for emulating parts with >28 pins are accessible via receptacles on top of the prototyping module

Prototyping Modules (CY3210-2xxxx) are not to be confused with *Emulation* PODs (CY3250-2xxxx), although they also connect to the ICE-Cube (CY3215-DK).

## I<sup>2</sup>C-USB Bridge (CY3240-I2USB)

The main purpose of the I<sup>2</sup>C -USB Bridge is to test, tune, and debug programs that have an I<sup>2</sup>C slave interface. This application can also be useful for data acquisition and regulation under PC control. Cypress offers CY3240-I2USB that supports I<sup>2</sup>C interface and communication to test, debug and tune device designs in many PSoC kits.

There is a table of I<sup>2</sup>C -USB Bridge kits located in the Appendix.

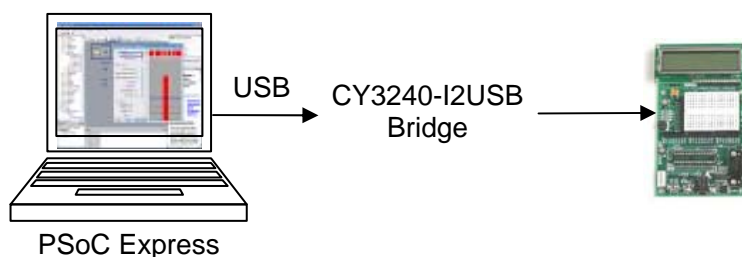

The I<sup>2</sup>C-USB bridge allows hardware and software debug of PSoC Express applications by bridging the USB port to I<sup>2</sup>C.



## Kits

### DEMO/STARTER KITS

P/N	Description	Kit Contents	Photo
CY3270	<p><b>PSoC® FirstTouch™ Kit</b></p> <p><a href="http://www.cypress.com/FirstTouch">www.cypress.com/FirstTouch</a></p> <ul style="list-style-type: none"> <li>The PSoC FirstTouch Starter Kit is a USB thumb drive kit that provides a quick, easy, and affordable way for embedded customers to evaluate the integration, flexibility, and real mixed-signal programmability of PSoC mixed-signal arrays.</li> <li>Without writing or debugging a single line of C or Assembly code, the PSoC FirstTouch Starter Kit, working with Cypress's PSoC Express software development tool, provides designers with CapSense touch, temperature, light and CapSense proximity sensing right out of the box.</li> <li>Customers can also experiment with many more designs available or build their own in minutes via PSoC Express. They can also add all of this functionality directly to their own development systems via the detachable expansion card.</li> <li>The expansion card includes inputs and outputs for the many applications supported by the kit. No other thumb drive kit offers such an extensive array of applications.</li> </ul>	<ul style="list-style-type: none"> <li>Two small boards -- a main system board that interfaces with a computer over USB, and a detachable multifunction expansion card.</li> <li>User Guide</li> <li>Installation CD</li> <li>A proximity sensing antenna</li> </ul>	
CY3235-PROXDET	<p><b>CapSense™ Proximity Detection Demonstration Kit</b></p> <ul style="list-style-type: none"> <li>The CapSense Proximity Detection Demonstration Kit allows quick and easy demonstration of a PSoC CapSense-enabled device (CY8C21434) to accurately sense the proximity of a hand or finger along the length of a wire antenna.</li> <li>The kit also includes the I<sup>2</sup>C to USB Bridge, which allows hardware and software debugging of PSoC applications by seamlessly connecting your PC's USB port to your application's I<sup>2</sup>C interface.</li> </ul>	<ul style="list-style-type: none"> <li>Proximity Detection Demo Board w/Antenna</li> <li>I<sup>2</sup>C to USB Debugging/Communication Bridge</li> <li>USB Cable (6 feet)</li> <li>Supporting Software CD</li> <li>CY3235-ProxDet Quick Start Guide</li> <li>1 CY8C24894 PSoC device on I2C-USB Bridge</li> <li>1 CY8C21434 PSoC device on Proximity Detection Demo Board</li> </ul>	

P/N	Description	Kit Contents	Photo
-----	-------------	--------------	-------

CY3242-IOXLite	<h3>I<sup>2</sup>C Port Expander Lite Demo Kit</h3> <p>The CY3242-IOXLite Demo Kit quickly demonstrates the following value propositions of Cypress' I<sup>2</sup>C port expander solutions:</p> <ul style="list-style-type: none"> <li>• Integration</li> <li>• Flexibility</li> <li>• Compatibility</li> </ul>	<ul style="list-style-type: none"> <li>• I<sup>2</sup>C Port Expander Demo Board using CY8C9520 PSoC(R) Port Expander Device</li> <li>• USB Cable from Board to PC</li> <li>• Kit Documentation and Design Files CD</li> </ul>	
----------------	--	--	---

One Cypress I2C Port Expander device replaces multiple port expander ICs from other vendors and flexibly integrates IO expansion, PWM functions and user EEPROM. It provides integration, flexibility and compatibility to PSoC users.

Cypress' three I2C port expander devices (CY8C9520, CY8C9540, CY8C9560) have the following features:

- Three compatible part families that seamlessly scale up or down
- 20, 40, or 60 individually configurable IO (widest range of I/Os in the industry)
- 4, 8, or 16 PWMs that map to any pin or multiple pins (widest range of PWMs in the industry)
- 3 Kbytes, 11 Kbytes, or 27 Kbytes of User EEPROM (largest amount of user-accessible serial EEPROM in the industry)
- I2C communication up to 400 kHz
- Industrial temp range: -40 to +85 degrees Celsius
- Operating voltage: 3.0V - 5.25V
- 28-SSOP/48-SSOP/100-TQFP package options

# EVALUATION KITS

P/N	Description	Kit Contents	Photo
CY3210-PSoCEval1	<p><b>PSoC Evaluation Kit</b></p> <ul style="list-style-type: none"> <li>This kit features an evaluation board and MiniProg1 programming unit. The evaluation board includes an LCD module, Potentiometer, LEDs, and plenty of breadboarding space to meet all of your evaluation needs.</li> <li>The MiniProg1 programming unit will program PSoC devices directly on the evaluation board or on other boards via a 5-pin header</li> </ul>	<ul style="list-style-type: none"> <li>Evaluation Board with LCD Module</li> <li>MiniProg Programming Unit</li> <li>28-Pin CY8C29466-24PXI PDIP PSoC Device Sample (2)</li> <li>PSoC Designer Software CD</li> <li>Getting Started Guide</li> <li>USB 2.0 Cable</li> </ul>	

## Express Evaluation Kit

The CY3209-ExpressEVK development kit allows one to put real-world applications together very quickly. This new kit demonstrates many aspects of PSoC with special emphasis on PSoC Express. The kit is physically divided into 4 parts, with each part associated with the CY8C21434, CY8C27643, CY8C24894 and CY8C29666 devices respectively. PSoCs can be I2C networked. The CY3209-ExpressEVK contains an enhanced version of the PSoC Express World Tour board (CY3121-Customer.) The kit includes software, hardware and example projects to help designers learn how to implement and evaluate the following functions:

CY3209-ExpressEVK

- Wireless Communication
- "Drag and drop" USB - allows the user to implement full-speed USB 2.0 simply by dragging the USB-UART driver icon onto the Design Desktop within the PSoC SW Design Tool's Integrated Design Environment.
- Implement LCD Control on the board in 5 easy steps: Drop the icon, define the transfer function, Build the project, download to the target & test in real time!
- Accelerometer Tilt Sensing
- Voltage Monitoring

- Express Evaluation Board
- 5V LCD Module
- MiniProg Programming Unit
- USB Cable
- 2 Artaflex 2.4GHz Radios
- 9V Battery
- CY3209-ExpressEVK Kit CD
- Quick Start Guide

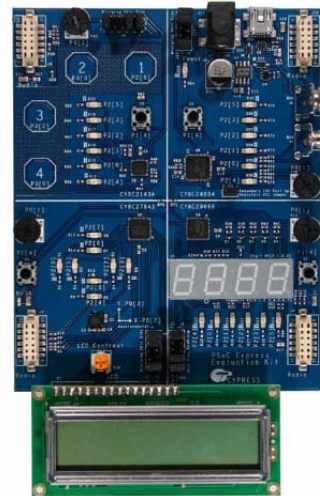

P/N	Description	Kit Contents	Photo
<b>CY3203A-CapSense</b>	<p><b>CY3203A-CapSense CSA Evaluation Kit</b></p> <ul style="list-style-type: none"> <li>An excellent CapSense learning resource with software, hardware and example projects to help designers learn how to implement PSoC CapSense in their own design using the CY8C20x34 family with CSA-type sensing.</li> <li>A training board is included that is hardwired for buttons and sliders as well as LCD control and I<sup>2</sup>C communication.</li> </ul>	<ul style="list-style-type: none"> <li>Training board (CY8C20x34)</li> <li>PSoC Designer and Example Project CD</li> <li>CSA User Module</li> <li>Mini Programmer unit</li> <li>LCD module</li> <li>USB cable</li> </ul>	
<b>CY3213A-CapSense</b>	<p><b>CY3213A-CapSense CSD Evaluation Kit</b></p> <ul style="list-style-type: none"> <li>An excellent CapSense learning resource with software, hardware and example projects to help designers learn how to implement PSoC CapSense in their own design using the CY8C21x34 family with CSD-type sensing.</li> <li>A training board is included that is hardwired for buttons and sliders as well as LCD control and I<sup>2</sup>C communication.</li> </ul>	<ul style="list-style-type: none"> <li>Training board (CY8C21x34)</li> <li>PSoC Designer and Example Project CD</li> <li>CSD User Module</li> <li>Mini Programmer unit</li> <li>LCD module</li> <li>USB cable</li> </ul>	
<b>CY3214-PSoCEvalUSB</b>	<p><b>CapSensePLUS with USB Evaluation Kit</b></p> <ul style="list-style-type: none"> <li>This new evaluation kit is specifically for the CY8C24794. It includes an evaluation board and MiniProg1 programming unit.</li> <li>The evaluation board features an On-Chip Debugger (OCD). The OCD allows full-featured, on-board emulation of the CY8C24794 when combined with an ICE-Cube (available in the CY3215-DK).</li> <li>The board also features USB connectivity and CapSense buttons and slider. Also included on the board is an LCD module, potentiometer, LEDs, an enunciator, and plenty of breadboarding space to meet all of your evaluation needs</li> </ul>	<ul style="list-style-type: none"> <li>CY8C24794 Evaluation Board with LCD Module</li> <li>MiniProg Programming Unit</li> <li>PSoC Designer Software CD</li> <li>PSoC Support CD (with CY8C24794 Example Projects)</li> <li>Getting Started Guide</li> <li>USB 2.0 Cable</li> </ul>	
<b>CY3210-MiniProg1</b>	<p><b>Mini-Programmer Evaluation Kit</b></p> <ul style="list-style-type: none"> <li>MiniEval board is a programming and evaluation board that allows socket programming of DIP devices.</li> <li>It also includes LEDs and a POT for simple evaluation and demonstration, but does not include a prototyping area.</li> <li>The MiniProg utilizes a 5-pin ISSP header to program PSoC devices on the MiniEval board or directly on a target board.</li> <li>The CY32310-MiniProg1 is fully qualified for prototype and production programming; however, the small-format plastic enclosure was not designed to withstand the constant use often experienced on a manufacturing assembly line. Cypress recommends the CY3027ISSP as a more appropriate production programming solution.</li> </ul>	<ul style="list-style-type: none"> <li>MiniProg Programming Unit</li> <li>MiniEval Socket Programming and Evaluation Board</li> <li>28-Pin CY8C29466-24PXI PDIP PSoC Device Sample</li> <li>28-Pin CY8C27443-24PXI PDIP PSoC Device Sample</li> <li>PSoC Designer Software CD</li> <li>Getting Started Guide</li> <li>USB 2.0 Cable</li> </ul>	

P/N	Description	Kit Contents	Photo
-----	-------------	--------------	-------





**CY3210-SDCARD**

**SD Card Module Evaluation Kit**

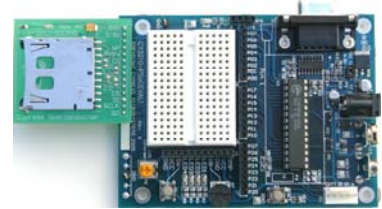

The SD Card Module Evaluation Kit assesses the PSoC SD Card user module's ability to quickly and easily write to, read from and seamlessly integrate an SD card module into an embedded design. Secure Digital (SD) flash memory technologies are quickly becoming the preferred solution for portable, consumer and industrial electronic devices around the world for storing a large amount of information in a small, durable, portable form factor.

- CY3210-PSoCEval1 Rev. B Board
- SD Card Adapter Board
- SD Memory Card
- USB to SD Card Reader
- MiniProg1
- USB Cable
- 12V Power Supply
- One CY8C29466-24PXI 28-pin DIP sample
- PSoC Designer(TM) and PSoC Programmer CD
- Cypress Support Card



P/N	Description	Kit Contents	Photo
CY3261A- RGB	<p><b>RGB High Brightness LED Kit</b></p> <p>The CY3261A-RGB board is a preprogrammed HB LED color mix board with seven pre-set colors using the CY8CLED16 EZ-Color HB LED Controller. The color selector software application can be installed on a host PC and is used to control the EZ-Color HB LED controller using the included USB cable. The application enables you to select colors via a CIE 1931 chart or by entering coordinates.</p>	<ul style="list-style-type: none"> <li>• CY3261A-RGB board</li> <li>• PSoC Designer(TM) and PSoC Programmer CD</li> <li>• USB cable</li> <li>• Power cable</li> </ul>	
CY3220 LINBus-RD	<p><b>LIN bus Evaluation Kit</b></p> <p>The design kit includes the necessary software, hardware, and example projects for designers to implement all of the functions of the LIN specifications without having to generate any new code. The LIN Protocol Specification is a low-speed communications standard used in many automotive applications, including body control, driver information, multimedia, climate control, safety equipment, cockpit electronics and Human Machine Interface (HMI).</p>	<ul style="list-style-type: none"> <li>• LIN Bus Reference Design Board</li> <li>• Three preprogrammed and preinstalled PSoC devices (two CY8C27443-24PXI LIN bus slaves and one CY8C27143-24PXI LIN bus master)</li> <li>• Software CD with Documentation, Example Projects, and Reference Design IP</li> <li>• 12V Power Supply</li> <li>• International Supply Adapter</li> <li>• DB9 Serial Cable</li> </ul>	
CY3236A- PIRMOTION	<p><b>Pyroelectric Infrared Motion Detection Evaluation Kit</b></p> <ul style="list-style-type: none"> <li>• The CY3236A-PIRMOTION EVK allows you to evaluate PSoC device's ability to control a Pyroelectric Infrared (PIR) sensor to implement motion sensing applications such as automatic lighting controls, automatic door openers, security systems, kiosk wakeup and activating wireless cameras.</li> <li>• The CY3236A-PIRMOTION EVK includes all of the software, hardware, example projects and documentation you need to implement all of these PIR sensing control functions in one flexible and powerful PSoC device, the CY8C27443.</li> </ul>	<ul style="list-style-type: none"> <li>• PIR Motion Sensor Board using CY8C27443-24PVXI PSoC(R) device</li> <li>• 12V Power Supply</li> <li>• PSoC Designer(TM) and PSoC Programmer CD</li> <li>• Design Files CD (Schematic, BOM, Gerber Files, PSoC Designer Example Project)</li> </ul>	
CY3242-IOX	<p><b>I<sup>2</sup>C Port Expander Evaluation Kit</b></p> <p>The I<sup>2</sup>C Port Expander Evaluation Kit allows you to easily assess the integration, flexibility and compatibility of Cypress' I<sup>2</sup>C port expander solution. This kit also includes the I<sup>2</sup>C -USB Bridge, which allows hardware and software debugging of PSoC applications by seamlessly connecting your PC's USB port to your application's I<sup>2</sup>C interface.</p>	<ul style="list-style-type: none"> <li>• I<sup>2</sup>C Port Expander Evaluation Board</li> <li>• I<sup>2</sup>C -USB Bridge</li> <li>• USB Cable (6ft/2m)</li> <li>• 5V-2A DC Power Supply</li> <li>• Strip of 10 Post Shunts</li> <li>• I<sup>2</sup>C Port Expander Evaluation Kit Mini-CD</li> </ul>	

# DEVELOPMENT KITS

P/N	Description	Kit Contents	Photo
CY3215-DK	<p><b>Basic Development Kit</b></p> <p>The CY3215-DK development kit includes a tiny footprint, high-speed in-circuit USB 2.0-based emulator with a large trace buffer. This kit provides most everything you need to develop your designs with PSoC.</p>	<ul style="list-style-type: none"> <li>• Image Craft C-Compiler License (also orderable separately as CY3202-C)</li> <li>• ICE-Cube Unit</li> <li>• 28 pin PDIP Emulation Pod for CY8C29466-24PXI</li> <li>• 28 pin CY8C29466-24PXI PDIP PSoC Device Samples (two)</li> <li>• PSoC Designer Software CD</li> <li>• ISSP Cable</li> <li>• MiniEval Socket Programming and Evaluation board</li> <li>• Backward compatibility cable (for connecting to legacy Pods)</li> <li>• Universal 110/220 Power Supply (12V)</li> <li>• European Plug Adapter</li> <li>• USB 2.0 Cable</li> <li>• Getting Started Guide</li> <li>• Development Kit Registration form</li> </ul>	
CY3280-BK1	<p><b>Universal CapSense Controller – Basic Kit 1</b></p> <ul style="list-style-type: none"> <li>• CapSense Development Kit for CY8C21x34 &amp; CY8C20x34 PSoC device families</li> <li>• The CY3280-BK1 Universal CapSense Controller Kit is designed for easy prototyping and debug of CapSense designs with pre-defined control circuitry and plug-in hardware. The kit comes with controller boards for the CY8C20x34 and CY8C21x34 PSoC devices as well as a breadboard module and a button (5) / slider module.</li> </ul>	<ul style="list-style-type: none"> <li>• CY3280-20x34 Board</li> <li>• CY3280-21x34 Board</li> <li>• CY3280-SLM Slider Module</li> <li>• CY3280-BBM Prototyping Module</li> <li>• CY3240-I2USB Board</li> <li>• CY3210-MiniProg1 Programmer</li> <li>• USB 2.0 Retractable Cable</li> <li>• PSoC Express Installation CD</li> <li>• PSoC Designer and PSoC Programmer Installation CD</li> <li>• CY3280-BK1 Universal CapSense Controller Kit CD</li> <li>• 1.5 mm and 3 mm Polycarbonate Overlays</li> </ul>	

P/N	Description	Photo
-----	-------------	-------

CY3240-I2USB

I<sup>2</sup>C – USB Bridge Kit (Rev A)

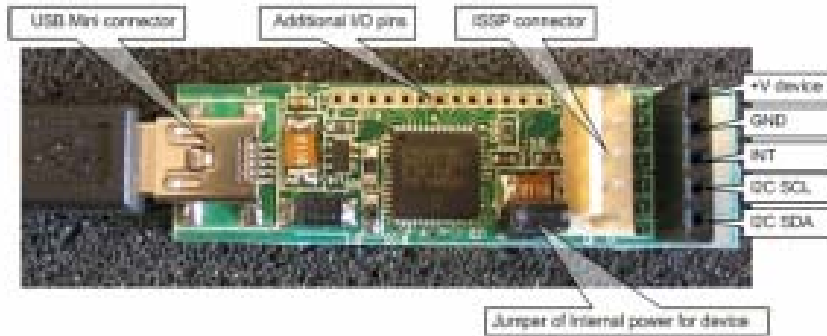



The I2C-USB Bridge Kit allows one to test, tune and debug hardware and software of a PSoC application by bridging the USB port to I<sup>2</sup>C. Populated with the CY8C24894 PSoC device. A wide variety of devices can be connected to the PC using this bridge. Among them are: EEPROMs, real-time clocks, ADC/DAC converters, LCD displays, regulated DC/DC converters, port expanders and many other devices incorporating the I2C interface. The number of devices that can be connected is constrained only by the I2C address limit and physical ability of the I2C bus. The above photo is a larger view of the board shown to the right.



- I2C-USB Bridge
- I2C Slave Demonstration Board
- USB Mini B Cable (6 feet)
- Supporting Software CD

# PSoC PROGRAMMING KITS

P/N	Description	Kit Contents	Photo
CY3210- MiniProg1	<p><b>“MiniProg” Programmer with Evaluation board</b></p> <ul style="list-style-type: none"> <li>• MiniEval board is a programming and evaluation board that allows socket programming of DIP devices.</li> <li>• It also includes LEDs and a POT for simple evaluation and demonstration, but does not include a prototyping area.</li> <li>• The MiniProg utilizes a 5-pin ISSP header to program PSoC devices on the MiniEval board or directly on a target board.</li> <li>• The MiniProg is fully qualified for prototype and production programming; however, the small-format plastic enclosure was not designed to withstand the constant use often experienced on a manufacturing assembly line.</li> <li>• Cypress recommends the CY3027ISSP as a more appropriate production programming solution.</li> </ul>	<ul style="list-style-type: none"> <li>• MiniProg (or “MiniProg1”) Programming Unit</li> <li>• MiniEval Socket Programming and Evaluation Board</li> <li>• 28-Pin CY8C29466-24PXI PDIP PSoC Device Sample</li> <li>• 28-Pin CY8C27443-24PXI PDIP PSoC Device Sample</li> <li>• PSoC Designer Software CD</li> <li>• Getting Started Guide</li> <li>• USB 2.0 Cable</li> </ul>	
CY3217	<p><b>“MiniProg1” Programmer</b></p> <p>Mini-programmer only.</p> <p>Not for industrial or production programming use.</p>	<ul style="list-style-type: none"> <li>• MiniProg programmer device</li> <li>• Std-A to Mini-B USB cable in a reel</li> </ul>	

P/N	Description	Kit Contents	Photo
-----	-------------	--------------	-------

<p><b>CY3215-DK</b></p>	<p><b>Basic Development Kit</b></p> <p>The CY3215-DK development kit includes a tiny footprint, high-speed in-circuit USB 2.0-based emulator with a large trace buffer</p>	<ul style="list-style-type: none"> <li>• Image Craft C-Compiler License (also orderable separately as CY3209-C)</li> <li>• ICE-Cube Unit</li> <li>• 28 pin PDIP Emulation Pod for CY8C29466-24PXI</li> <li>• 28 pin CY8C29466-24PXI PDIP PSoC Device Samples (two)</li> <li>• PSoC Designer Software CD</li> <li>• ISSP Cable</li> <li>• MiniEval Socket Programming and Evaluation board</li> <li>• Backward compatibility cable (for connecting to legacy Pods)</li> <li>• Universal 110/220 Power Supply (12V)</li> <li>• European Plug Adapter</li> <li>• USB 2.0 Cable</li> <li>• Getting Started Guide</li> <li>• Development Kit Registration form</li> </ul>
-------------------------	--	--



<p><b>CY3207ISSP</b></p>	<p><b>In-System Serial Programmer</b></p> <p>Production-unit programmer. It includes protection circuitry and an industrial case that is more robust than the MiniProg and the ICE for a production-programming environment. The CY3207ISSP can program parts in-system via serial connection, or mounted in the socket on the CY3207ISSP. May require adapters for CY3207ISSP socket programming.</p>	<ul style="list-style-type: none"> <li>• User Manual</li> <li>• Production-unit Programmer</li> </ul>
--------------------------	--	---



# KIT COMPONENTS & ACCESSORIES

## Foot & Emulation POD Selection Guide

Use this table when selecting an emulation kit and package adapter (foot) for use with your CY3215-DK (In-circuit emulation and programming kit.) Each Emulation Kit contains one POD and two FEET. However, the FEET in each Emulation Kit are a default PDIP style. To emulate with a specific package type, a FOOT of the proper type must be added. FEET come in four to a package and are intended to be disposable for ease-of-use (typically with the Flexcable. See the *Programming Methods* section above for details.)

If you know your PSoC device family and the package type, or the specific PSoC device part number, you will find the recommended Emulation kit (POD + 2 FEET/Package Adapters) below. In most cases, you will also need a foot *that matches your package type* or additional feet to save you time (however, re-use of a FOOT is possible.)

Each table below represents a *family* of PSoC devices.

Chip Part Number	Package	Dev. Kit	Emulation Kit (POD)	Foot Kit (Pack of 4 )	Programmer**
CY8C29466-24PXI	28 PDIP	CY3215-DK	CY3250-29XXX	CY3250-28PDIP-FK	ISSP or MiniProg
CY8C29466-24PVXI	28 SSOP	CY3215-DK	CY3250-29XXX	CY3250-28SSOP-FK*	ISSP or MiniProg
CY8C29466-24SXI	28 SOIC	CY3215-DK	CY3250-29XXX	CY3250-28SOIC-FK*	ISSP or MiniProg
CY8C29566-24AXI	44 TQFP	CY3215-DK	CY3250-29XXX	CY3250-44TQFP-FK*	ISSP or MiniProg
CY8C29666-24PVXI	48 SSOP	CY3215-DK	CY3250-29XXX	CY3250-48SSOP-FK*	ISSP or MiniProg
CY8C29666-24LFXI	48 QFN	CY3215-DK	CY3250-29XXXQFN	CY3250-48QFN-FK	ISSP or MiniProg
CY8C29866-24AXI	100 TQFP	CY3215-DK	CY3250-29XXX	CY3250-100TQFP-FK*	ISSP or MiniProg

\*Foot Kit is required in conjunction with Emulation Kit to emulate with the package of this chip part number.

\*\*Programming adapter may be required. ISSP refers to part number CY3207ISSP; MiniProg refers to part number CY3210-MiniProg1

Chip Part Number	Package	Dev. Kit	Emulation Kit (POD)	Foot Kit (Pack of 4 )	Programmer**
CY8C27143-24PXI	8 PDIP	CY3215-DK	CY3250-27XXX	CY3250-8PDIP-FK*	ISSP or MiniProg
CY8C27243-24PVXI	20 SSOP	CY3215-DK	CY3250-27XXX	CY3250-20SSOP-FK*	ISSP or MiniProg
CY8C27243-24SXI	20 SOIC	CY3215-DK	CY3250-27XXX	CY3250-20SOIC-FK*	ISSP or MiniProg
CY8C27443-24PXI	28 PDIP	CY3215-DK	CY3250-27XXX	CY3250-28PDIP-FK	ISSP or MiniProg
CY8C27443-24PVXI	28 SSOP	CY3215-DK	CY3250-27XXX	CY3250-28SSOP-FK*	ISSP or MiniProg
CY8C27443-24SXI	28 SOIC	CY3215-DK	CY3250-27XXX	CY3250-28SOIC-FK*	ISSP or MiniProg
CY8C27543-24AXI	44 TQFP	CY3215-DK	CY3250-27XXX	CY3250-44TQFP-FK*	ISSP or MiniProg
CY8C27643-24PVXI	48 SSOP	CY3215-DK	CY3250-27XXX	CY3250-48SSOP-FK*	ISSP or MiniProg
CY8C27643-24LFXI	48 QFN	CY3215-DK	CY3250-27XXXQFN	CY3250-48QFN-FK	ISSP or MiniProg

\*Foot Kit is required in conjunction with Emulation Kit to emulate this package.

\*\*Programming adapter may be required. ISSP refers to part number CY3207ISSP; MiniProg refers to part number CY3210-MiniProg1

Chip Part Number	Package	Dev. Kit	Emulation Kit (POD)	Foot Kit (Pack of 4 )	Programmer**
CY8C24794-24LFXI	56 QFN	CY3215-DK	CY3250-24X94QFN	CY3250-56QFN-FK	ISSP or MiniProg
CY8C24894-24LFXI	56 QFN	CY3215-DK	CY3250-24X94QFN	CY3250-56QFN-FK	ISSP or MiniProg

\*\*Programming adapter may be required. ISSP refers to part number CY3207ISSP; MiniProg refers to part number CY3210-MiniProg1

Chip Part Number	Package	Dev. Kit	Emulation Kit (POD)	Foot Kit (Pack of 4 )	Programmer**
CY8C24123A-24PXI	8 PDIP	CY3215-DK	CY3250-24X23A	CY3250-8PDIP-FK*	ISSP or MiniProg
CY8C24123A-24SXI	8 SOIC	CY3215-DK	CY3250-24X23A	CY3250-8SOIC-FK*	ISSP or MiniProg
CY8C24223A-24PXI	20 PDIP	CY3215-DK	CY3250-24X23A	CY3250-20PDIP-FK*	ISSP or MiniProg
CY8C24223A-24PVXI	20 SSOP	CY3215-DK	CY3250-24X23A	CY3250-20SSOP-FK*	ISSP or MiniProg
CY8C24223A-24SXI	20 SOIC	CY3215-DK	CY3250-24X23A	CY3250-20SOIC-FK*	ISSP or MiniProg
CY8C24423A-24PXI	28 PDIP	CY3215-DK	CY3250-24X23A	CY3250-28PDIP-FK	ISSP or MiniProg
CY8C24423A-24PVXI	28 SSOP	CY3215-DK	CY3250-24X23A	CY3250-28SSOP-FK*	ISSP or MiniProg
CY8C24423A-24SXI	28 SOIC	CY3215-DK	CY3250-24X23A	CY3250-28SOIC-FK*	ISSP or MiniProg
CY8C24423A-24LFXI	32 QFN	CY3215-DK	CY3250-24X23AQFN	CY3250-32QFN-FK	ISSP or MiniProg

\*Foot Kit is required in conjunction with Emulation Kit to emulate this package.

\*\*Programming adapter may be required. ISSP refers to part number CY3207ISSP; MiniProg refers to part number CY3210-MiniProg1

Chip Part Number	Package	Dev. Kit	Emulation Kit (POD)	Foot Kit (Pack of 4 )	Programmer**
CY8C21234-24SXI	16 SOIC	CY3215-DK	CY3250-21X34	CY3250-16SOIC-FK*	ISSP or MiniProg
CY8C21334-24PVXI	20 SSOP	CY3215-DK	CY3250-21X34	CY3250-20SSOP-FK	ISSP or MiniProg
CY8C21434-24LFXI	32 QFN	CY3215-DK	CY3250-21X34QFN	CY3250-32QFN-FK	ISSP or MiniProg
CY8C21534-24PVXI	28 SSOP	CY3215-DK	CY3250-21X34	CY3250-28SSOP-FK	ISSP or MiniProg
CY8C21634-24LFXI	32 QFN	CY3215-DK	CY3250-21X34QFN	CY3250-32QFN-FK	ISSP or MiniProg

\*Foot Kit is required in conjunction with Emulation Kit to emulate this package.

\*\*Programming adapter may be required. ISSP refers to part number CY3207ISSP; MiniProg refers to part number CY3210-MiniProg1

Chip Part Number	Package	Dev. Kit	Emulation Kit (POD)	Foot Kit (Pack of 4 )	Programmer**
CY8C21123-24SXI	8 SOIC	CY3215-DK	CY3250-21X23	CY3250-8SOIC-FK*	ISSP or MiniProg
CY8C21223-24SXI	16SOIC	CY3215-DK	CY3250-21X23	CY3250-16SOIC-FK*	ISSP or MiniProg
CY8C21323-24PVXI	20 SSOP	CY3215-DK	CY3250-21X23	CY3250-20SSOP-FK	ISSP or MiniProg
CY8C21323-24LFXI	24 QFN	CY3215-DK	CY3250-21x23QFN	CY3250-24QFN-FK	ISSP or MiniProg

\*Foot Kit is required in conjunction with Emulation Kit to emulate this package.

\*\*Programming adapter may be required. ISSP refers to part number CY3207ISSP; MiniProg refers to part number CY3210-MiniProg1

Chip Part Number	Package	Dev. Kit	Emulation Kit (POD)	Foot Kit (Pack of 4 )	Programmer**
CY8C20334-12LKXI	24 QFN	CY3215-DK	CY3250-20334QFN	CY3250-24QFN-FK	ICE
CY8C20234-12LKXI	16 QFN	CY3215-DK	NaN	CY3250-16QFN-FK	ICE
CY8C20434-12LFXI	32 QFN	CY3215-DK	CY3250-20434QFN	CY3250-32QFN-FK	ICE

\*Foot Kit is required in conjunction with Emulation Kit to emulate this package.

\*\*Programming adapter may be required. ISSP refers to part number CY3207ISSP; MiniProg refers to part number CY3210-MiniProg1

# KIT COMPONENTS AND ACCESSORIES

## Ordering Information

Part Number	Function	Contents	Price (MSRP)
CY3250-FLEXCABLE	Replacement Flexcable for PSoC CY3250 ICE Pod Kit	One (1) Flexcable	\$38.00
CY3250-24X94QFN	Emulation support for CY8C24794-24LFXI and CY8C24894-24LFXI devices. The QFN pod provides the interconnection between the ICE base unit and the target hardware includes 56-QFN Feet (2).	One (1) 24X94QFN POD One (1) Flexcable Two (2) 56QFN Feet	\$135.00
CY3250-24X23AQFN	Emulation support for CY8C24423A-LFXI device. The QFN pod provides the interconnection between the ICE base unit and the target hardware, includes 32-QFN Feet (2).	One (1) 24X23AQFN POD One (1) Flexcable Two (2) 32QFN Feet	\$135.00
CY3250-27XXXQFN	Emulation support for CY8C27643-LFXI device. The QFN pod provides the interconnection between the ICE base unit and the target hardware, includes 48-QFN Feet (2).	One (1) 27XXXQFN POD One (1) Flexcable Two (2) 48QFN Feet	\$135.00
CY3250-29XXXQFN	Emulation support for CY8C29666-LFXI device. The QFN pod provides the interconnection between the ICE base unit and the target hardware, includes 48-QFN Feet (2).	One (1) 29XXXQFN POD One (1) Flexcable Two (2) 48QFN Feet	\$135.00
CY3250-21X23QFN	Emulation support for CY8C21323-LFXI device. The QFN pod provides the interconnection between the ICE base unit and the target hardware, includes 24-QFN Feet (2).	One (1) 21X23QFN POD One (1) Flexcable Two (2) 24QFN Feet	\$135.00
CY3250-21X34QFN	Emulation support for CY8C21434-LFXI and CY8C21634-LFXI devices. The QFN pod provides the interconnection between the ICE base unit and the target hardware, includes 32-QFN Feet (2).	One (1) 21X34 QFN POD One (1) Flexcable Two (2) 32QFN Feet	\$135.00
CY3250-24QFN-FK	Replacement PSoC CY3250 (24-pin QFN) Pod Feet	Four (4) 24QFN Feet	\$140.00
CY3250-32QFN-FK	Replacement PSoC CY3250 (32-pin QFN) Pod Feet	Four (4) 32QFN Feet	\$140.00
CY3250-48QFN-FK	Replacement PSoC CY3250 (48-pin QFN) Pod Feet	Four (4) 48QFN Feet	\$140.00
CY3250-56QFN-FK	Replacement PSoC CY3250 (56-pin QFN) Pod Feet	Four (4) 56QFN Feet	\$140.00
CY3250-24X94QFN-POD	Replacement PSoC CY3250-24x94QFN Pod	Two (2) 24X94QFN Pod	\$78.00
CY3250-24X23AQFN-POD	Replacement PSoC CY3250-24x23AQFN Pod	Two (2) 24X23AQFN Pod	\$78.00
CY3250-27XXXQFN-POD	Replacement PSoC CY3250-27XXXQFN Pod	Two (2) 27XXXQFN Pod	\$78.00
CY3250-29XXXQFN-POD	Replacement PSoC CY3250-29XXXQFN Pod	Two (2) 29XXXQFN Pod	\$78.00
CY3250-21X23QFN-POD	Replacement PSoC CY3250-21X23QFN Pod	Two (2) 21X23QFN Pod	\$78.00
CY3250-21X34QFN-POD	Replacement PSoC CY3250-21X34QFN Pod	Two (2) 21X34QFN Pod	\$78.00
CY3250-24X23A	Emulation support for CY8C24x23A devices. The pod provides the interconnection between the ICE base unit and the target hardware, includes 28PDIP Feet (2). This pod kit supports all non-QFN packages in combination with available CY3250 foot kit.	One (1) 24X23A POD One (1) Flexcable Two (2) 28PDIP Feet	\$135.00
CY3250-27XXX	Emulation support for CY8C27x43 devices. The pod provides the interconnection between the ICE base unit and the target hardware, includes 28PDIP Feet (2). This pod kit supports all non-QFN packages in combination with available CY3250 foot kit.	One (1) 27XXX POD One (1) Flexcable Two (2) 28PDIP Feet	\$135.00
CY3250-29XXX	Emulation support for CY8C29x66 devices. The pod provides the interconnection between the ICE base unit and the target hardware, includes 28PDIP Feet (2). This pod kit supports all non-QFN packages in combination with available CY3250 foot kit.	One (1) 29XXX POD One (1) Flexcable Two (2) 28PDIP Feet	\$135.00
CY3250-21X23	Emulation support for CY8C21x23 devices. The pod provides the interconnection between the ICE base unit and the target hardware, includes 20SSOP Feet (2). This pod kit supports all non-QFN packages in combination with available CY3250 foot kit.	One (1) 21X23 POD One (1) Flexcable Two (2) 20SSOP Feet	\$135.00
CY3250-21X34	Emulation support for CY8C21x34 devices. The pod provides the interconnection between the ICE base unit and the target hardware, includes 28SSOP Feet (2). This pod kit supports all non-QFN packages in combination with available CY3250 foot kit.	One (1) 21X34 POD One (1) Flexcable Two (2) 28SSOP Feet	\$135.00
CY3250-20PDIP-FK	Replacement PSoC CY3250 (20-pin DIP) Pod Feet	Four (4) 20PDIP Feet	\$140.00
CY3250-28PDIP-FK	Replacement PSoC CY3250 (28-pin DIP) Pod Feet	Four (4) 28PDIP Feet	\$140.00
CY3250-8PDIP-FK	Replacement PSoC CY3250 (8-pin DIP) Pod Feet	Four (4) 8PDIP Feet	\$140.00
CY3250-16SOIC-FK	Replacement PSoC CY3250 (16-pin SOIC) Pod Feet	Four (4) 16SOIC Feet	\$140.00
CY3250-20SOIC-FK	Replacement PSoC CY3250 (20-pin SOIC) Pod Feet	Four (4) 20SOIC Feet	\$140.00
CY3250-28SOIC-FK	Replacement PSoC CY3250 (28-pin SOIC) Pod Feet	Four (4) 28SOIC Feet	\$140.00
CY3250-8SOIC-FK	Replacement PSoC CY3250 (8-pin SOIC) Pod Feet	Four (4) 8SOIC Feet	\$140.00
CY3250-20SSOP-FK	Replacement PSoC CY3250 (20-pin SSOP) Pod Feet	Four (4) 20SSOP Feet	\$140.00
CY3250-28SSOP-FK	Replacement PSoC CY3250 (28-pin SSOP) Pod Feet	Four (4) 28SSOP Feet	\$140.00
CY3250-48SSOP-FK	Replacement PSoC CY3250 (48-pin SSOP) Pod Feet	Four (4) 48SSOP Feet	\$140.00
CY3250-100TQFP-FK	Replacement PSoC CY3250 (100-pin TQFP) Pod Feet	Four (4) 100TQFP Feet	\$180.00
CY3250-44TQFP-FK	Replacement PSoC CY3250 (44-pin TQFP) Pod Feet	Four (4) 44TQFP Feet	\$140.00
CY3250-24X94-POD	Replacement PSoC CY3250-24x94 Pod	Two (2) 24X94 Pod	\$78.00
CY3250-24X23A-POD	Replacement PSoC CY3250-24X23A Pod	Two (2) 24X23A Pod	\$78.00
CY3250-27XXX-POD	Replacement PSoC CY3250-27XXX Pod	Two (2) 27XXX Pod	\$78.00
CY3250-29XXX-POD	Replacement PSoC CY3250-29XXX Pod	Two (2) 29XXX Pod	\$78.00
CY3250-21X23-POD	Replacement PSoC CY3250-21X23 Pod	Two (2) 21X23 Pod	\$78.00
CY3250-21X34-POD	Replacement PSoC CY3250-21X34 Pod	Two (2) 21X34 Pod	\$78.00



# KIT COMPONENTS AND ACCESSORIES

## FOOT / Package Adapters

### Replacement of ICE Pod Feet

The following table lists several examples of package adapters (FEET) with photos. These are In-Circuit Emulator (ICE) pod feet for debugging x-pin PDIP PSoC devices with the CY3215-DK ICE and accessory CY3250-2xxxx ICE PODs (not shown).  
 CY3215-DK and CY3250-2xxxx kits are sold separately.

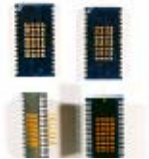
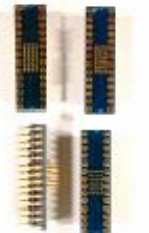

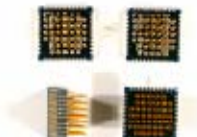
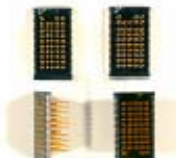
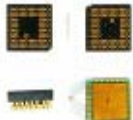
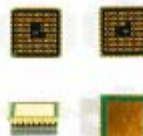
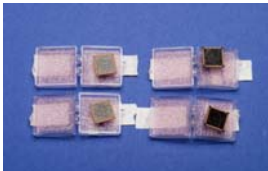
P/N	Description	Kit Contents	Photo
CY3250-8PDIP-FK	Replacement ICE Pod Feet (4) for Debugging 8-Pin PDIP PSoC Devices	<ul style="list-style-type: none"> <li>Four (4) 8-pin PDIP ICE Pod Feet</li> </ul>	
CY3250-8SOIC-FK	Replacement In-Circuit Emulation (ICE) Pod Feet for Debugging 8-pin SOIC PSoC Devices (Four feet included)	<ul style="list-style-type: none"> <li>Four (4) 8-pin SOIC ICE Pod Feet</li> </ul>	N/A
CY3250-16SOIC-FK	Replacement In-Circuit Emulation (ICE) Pod Feet for Debugging 16-pin SOIC PSoC Devices (Four feet included)	<ul style="list-style-type: none"> <li>Four (4) 16-pin SOIC ICE Pod Feet</li> </ul>	N/A
CY3250-20PDIP-FK	Replacement ICE Pod Feet (4) for Debugging 20-Pin PDIP PSoC Devices	<ul style="list-style-type: none"> <li>Four (4) 20-pin PDIP ICE Pod Feet</li> </ul>	
CY3250-20SOIC-FK	Replacement ICE Pod Feet (4) for Debugging 20-Pin SOIC PSoC Devices	<ul style="list-style-type: none"> <li>Four (4) 20-pin SOIC ICE Pod Feet</li> </ul>	
CY3250-20SSOP-FK	Replacement ICE Pod Feet (4) for Debugging 20-Pin SSOP PSoC Devices	Four (4) 20-Pin SSOP ICE Pod Feet	
CY3250-28SSOP-FK	Replacement ICE Pod Feet (4) for Debugging 28-Pin SSOP PSoC Devices	<ul style="list-style-type: none"> <li>Four (4) 28-pin SSOP ICE Pod Feet</li> </ul>	

P/N	Description	Kit Contents	Photo
<b>CY3250-28SOIC-FK</b>	Replacement ICE Pod Feet (4) for Debugging 28-Pin SOIC PSoC Devices	<ul style="list-style-type: none"> <li>Four (4) 28-Pin SOIC ICE Pod Feet</li> </ul>	
<b>CY3250-28PDIP-FK</b>	Replacement ICE Pod Feet (4) for Debugging 28-Pin PDIP PSoC Device	<ul style="list-style-type: none"> <li>Four (4) 28-Pin PDIP ICE Pod Feet</li> </ul>	
<b>CY3250-32QFN-FK</b>	Replacement ICE Pod Feet (4) for Debugging 32-Pin QFN PSoC Devices	<ul style="list-style-type: none"> <li>Four (4) 32-Pin QFN ICE Pod Feet</li> </ul>	
<b>CY3250-44TQFP-FK</b>	Replacement ICE Pod Feet (4) for Debugging 44-Pin TQFP PSoC Devices	<ul style="list-style-type: none"> <li>Four (4) 44-Pin TQFP ICE Pod Feet</li> </ul>	
<b>CY3250-48SSOP-FK</b>	Replacement ICE Pod Feet (4) for Debugging 48-Pin SSOP PSoC Devices	<ul style="list-style-type: none"> <li>Four (4) 48-Pin SSOP ICE Pod Feet</li> </ul>	
<b>CY3250-48QFN-FK</b>	Replacement ICE Pod Feet (4) for Debugging 48-Pin QFN PSoC Devices	<ul style="list-style-type: none"> <li>Four (4) 48-Pin QFN ICE Pod Feet</li> </ul>	
<b>CY3250-56QFN-FK</b>	Replacement ICE Pod Feet (4) for Debugging 56-Pin QFN PSoC Devices	<ul style="list-style-type: none"> <li>Four (4) 56-Pin QFN ICE Pod Feet</li> </ul>	
<b>CY3250-100TQFP-FK</b>	Replacement ICE Pod Feet (4) for Debugging 100-Pin TQFT PSoC Devices	<ul style="list-style-type: none"> <li>Four (4) 100-pin TQFP ICE Pod Feet</li> </ul>	

# KIT COMPONENTS AND ACCESSORIES

## Prototyping Modules

Prototyping Modules are occasionally referred to as Evaluation PODs. See *Programming Methods* above for a description.

Kit	Description	Kit Contents	Photo
<b>CY3210-20x34</b>	CY3210-20x34 provides evaluation of the CY8C20x34 PSoC device family on any PSoC developer kit. PSoC developer kits sold separately.	<ul style="list-style-type: none"> <li>One (1) CY8C20x34 PSoC Prototyping Module</li> </ul>	
<b>CY3210-21x23</b>	CY3210-21x23 provides evaluation of the CY8C21x23 PSoC device family on any PSoC developer kit. PSoC developer kits sold separately.	<ul style="list-style-type: none"> <li>One (1) CY8C21x23 PSoC Prototyping Module</li> </ul>	
<b>CY3210-21x34</b>	CY3210-21x34 provides evaluation of the CY8C21x34 PSoC device family on any PSoC developer kit. PSoC developer kits sold separately.	<ul style="list-style-type: none"> <li>One (1) CY8C21x34 PSoC Prototyping Module</li> </ul>	
<b>CY3210-24x23</b>	CY3210-24x23 provides evaluation of the CY8C24x23A PSoC device family on any PSoC developer kit. PSoC developer kits sold separately.	<ul style="list-style-type: none"> <li>One (1) CY8C24x23 PSoC Prototyping Module</li> </ul>	
<b>CY3210-24x94</b>	CY3210-24x94 provides evaluation of the CY8C24x94 PSoC device family on any PSoC developer kit. PSoC developer kits sold separately.	<ul style="list-style-type: none"> <li>One (1) CY8C24x94 PSoC Prototyping Module</li> </ul>	
<b>CY3210-27x43</b>	CY3210-27x43 provides evaluation of the CY8C27x43 PSoC device family on any PSoC developer kit. PSoC developer kits sold separately.	<ul style="list-style-type: none"> <li>One (1) CY8C27x43 PSoC Prototyping Module</li> </ul>	

Kit	Description	Kit Contents	Photo
-----	-------------	--------------	-------

<b>CY3210-29x66</b>	CY3210-29x66 provides evaluation of the CY8C29x66 PSoC device family on any PSoC developer kit. PSoC developer kits sold separately.	<ul style="list-style-type: none"><li>One (1) CY8C29x66 PSoC Prototyping Module</li></ul>	
---------------------	--	---	--



## Third Party Tools

The following list includes 3rd-party programmer tools that have been specifically designed, tested, and qualified to support streamlined programming of PSoC Programmable System-on-Chip devices:

### **BP Microsystems:** <http://www.bpmicro.com/>

Programmer Model 1400 and 1700  
Running BP WIN Software Revision V4.64.0  
Supporting Cypress PSoC Devices CY8C21X23, CY8C21X34, CY8C22X13, CY8C24X23, CY8C27XXX, CY8C29XXX  
Qualified March 2007

### **HiLo:** <http://www.hilosystems.com.tw/>

Programmer Model All 100  
Running XACY8C2X.EXE" V1.42  
Supporting Cypress PSoC Devices CY8C21X23, CY8C21X34, CY8C24XXX, CY8C26XXX, CY8C27XXX, CY8C29XXX  
Qualified March 2007

### **Wave Technology:** <http://www.y1000.com>

Programmer Model Y1000  
Supporting Cypress PSoC Devices CY8C20434-12LKXI  
Qualified March 2007

The following lists 3<sup>rd</sup> party compilers that have been specifically designed, tested, and qualified to support PSoC Designer and Programmable System on Chip devices:

### **HI-TECH Software:** <http://www.htsoft.com>

HI-TECH C PRO for the PSoC® Mixed-Signal Array  
Supporting Cypress PSoC Devices  
Compiler for use with PSoC Designer™  
Released: October 2007  
Available for purchase at [www.cypress.com/hitech](http://www.cypress.com/hitech)

### **Image Craft Compiler:** <http://www.imagecraft.com>

CY3202-C  
Compiler for use with PSoC Designer™  
Available for purchase at [www.cypress.com/CY3202-C](http://www.cypress.com/CY3202-C)

For information and support on PSoC devices: <http://www.cypress.com/psoc>.  
Items may be purchased online at the Cypress Online Store: <http://www.cypress.com/> home page.  
Or you can purchase Development Tools from one of Cypress' accredited distributors.

Cypress Semiconductor  
198 Champion Court  
San Jose, CA 95134-1709  
Phone: 408-943-2600  
Fax: 408-943-4730  
<http://www.cypress.com>

© Cypress Semiconductor Corporation, 2006-2008. The information contained herein is subject to change without notice. Cypress Semiconductor Corporation assumes no responsibility for the use of any circuitry other than circuitry embodied in a Cypress product. Nor does it convey or imply any license under patent or other rights. Cypress products are not warranted nor intended to be used for medical, life support, life saving, critical control or safety applications, unless pursuant to an express written agreement with Cypress. Furthermore, Cypress does not authorize its products for use as critical components in life-support systems where a malfunction or failure may reasonably be expected to result in significant injury to the user. The inclusion of Cypress products in life-support systems application implies that the manufacturer assumes all risk of such use and in doing so indemnifies Cypress against all charges.