



# 产品规格书

## PRODUCT SPECIFICATION

客户名称 CUSTOMER: \_\_\_\_\_

产品型号 MODEL: MLT-8540H

客户型号 USER'S MODEL: \_\_\_\_\_

日期 DATE: 2019-11-30

江苏华能电子有限公司			客户回签		
HUAWHA			CUSTOMER		
SERVE RATIVITY			CUSTOMER RATIGY		
拟制 REPORT	审核 CHECKED	批准 APPROVED	检验 TEST	审核 CHECKED	批准 APPROVED
	工稿用章	张长华			

江苏华能电子有限公司

JIANGSU HUAWHA ELECTRONICS CO.,LTD

地址: 江苏省泰州市兴化市陈堡镇工业园区

ADD:Chenbao Industrial Park, Chenbao Town, Xinghua,Taizhou City, Jiangsu China.

电话 [TEL:0523-83710666](tel:0523-83710666)

传真 [FAX:0523-83724866](tel:0523-83724866)

网址: [www.huawha.com](http://www.huawha.com)

邮箱: [hndz\\_wwj@huawha.com](mailto:hndz_wwj@huawha.com)

**1.基本规格/General specification**

项目/Item		规格/Spec	条件/Condition
1	额定电压 Rated voltage	3.6Vo-p	
2	工作电压 Operation voltage	2.5~4.5Vo-p	
3	声压 Sound Pressure Level=SPL	Min 85dB	测试环境：标准状态，标准驱动电路， 额定电压 测试距离：0.1m Standard State,Standard Drive Circuit. Rated voltage,Distance at 0.1m
4	电流 current	Max80mA	
5	阻抗 Coil Resistance	16±5 Ω	
6	振荡频率 Oscillation frequency	2700Hz	
7	工作温度范围 Operating Temperature	-20~+70℃	声压 ≥85dB SPL ≥85dB
8	保存温度范围 Storage temperature	-30~+85℃	
9	外部尺寸 Externals size (mm)	8.5*8.5*4	参阅附图 Refer to the attached drawing
10	重量 Mass	1g	
11	材质 Housing Material	LCP	

**2.电气和声学测试条件/Electrical And Acoustical Measuring Condition**

**驱动电路/Recommended Driving Circuit**

**设置 Recommended Setting**

Resonant frequency, 1/2 duty cycle. Square wave.  
Signal amplitude should be large enough to saturate the transistor.

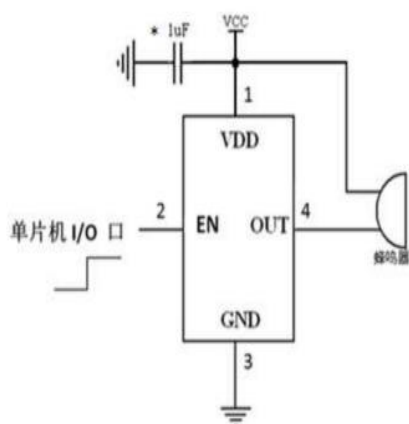

注：\*建议在芯片电源输入端增加1uF电源滤波电容。

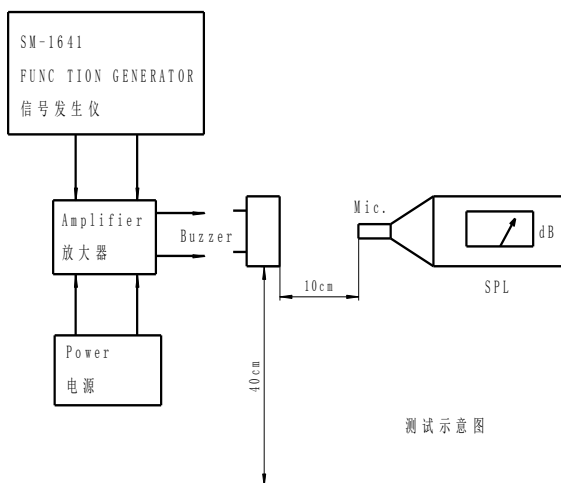

**3.可靠性测试/Reliability Test**

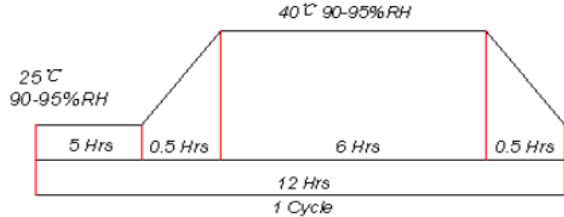
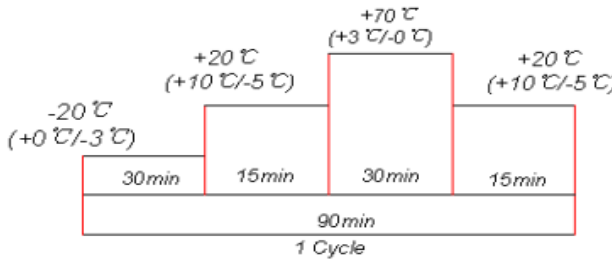
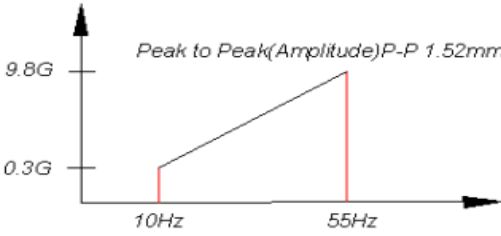
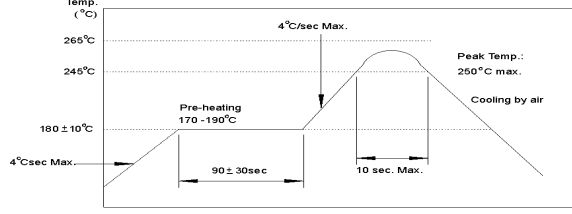
	项目 ITEM	测试方法 TEST
1	高温试验 High Temperature Test	在+80℃±2℃储存温度下存放 96 小时，恢复 2 小时后测试 After being placed in a chamber with +80±2℃ for 96 hours and then being placed in normal condition for 2 hours
2	低温试验 Low Temperature Test	在-20℃±2℃储存温度下存放 96 小时，恢复 2 小时后测试 After being placed in a chamber with -20±2℃ for 96 hours and then being placed in normal condition for 2 hours
3	恒定湿热试验 Humidity Test	
4	温度变化试验 Temperature Cycle Test	
5	振动试验 Vibration Test	
6	跌落试验 Drop Test	70cm 高自由掉落到 40mm 的木板上，每个方向三次 Drop on a hard wood board of 40mm thick, any directions, three times, at the height of 70cm
7	插针的抗拉强度试验 Terminal Strength Pulling Test	插针承受 1.0kg 拉力，负荷时间 5s The force 5 seconds of 1.0kg is applied to each terminal.
8	可焊性试验 Solder ability Test	焊锡温度 255±5℃，浸润时间为 3±0.5s，试验后目测产品情况 Lead terminals are immersed in rosin for 5 seconds and then immersed in solder bath of 255±5℃ for 3±0.5 seconds.
9	回流焊测试 Soldering Test	

--	--	--

#### 4.尺寸图 Dimension

\*Unit: mm; Toleran  
\*Housing Material

#### 5.1 Soldering pa

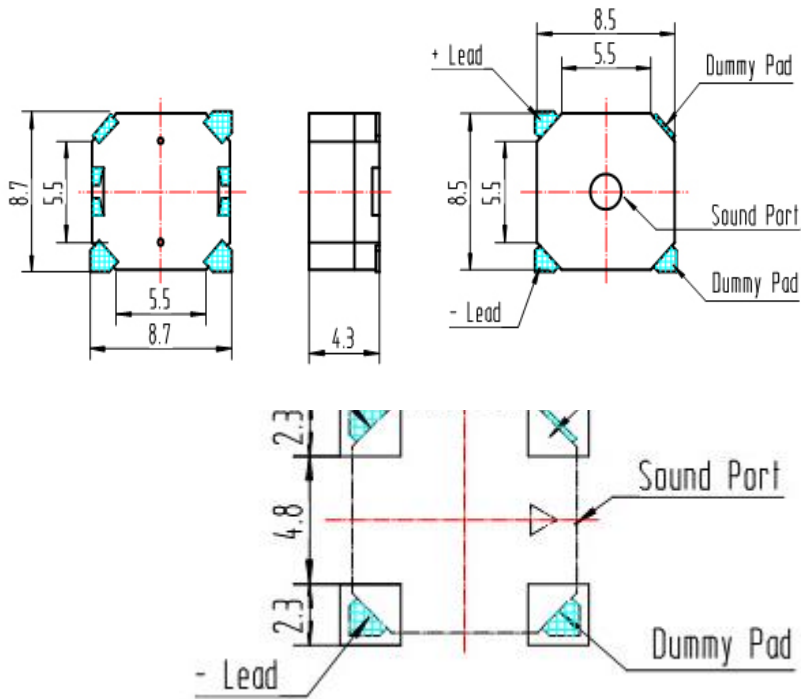

#### 5.频率响应/Frequency Response

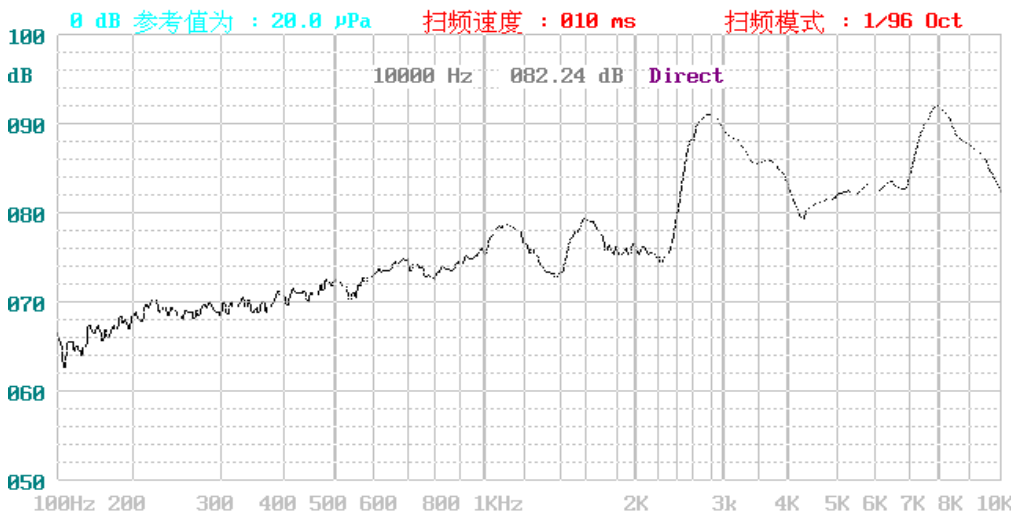

3.6Vo-p 50% duty Square wave,10cm

6.包装方式/Packing

