

晶体管光耦
Photo Transistor

LTV-357T

Product Data Sheet

AOTE DCC
RELEASE

SOP4

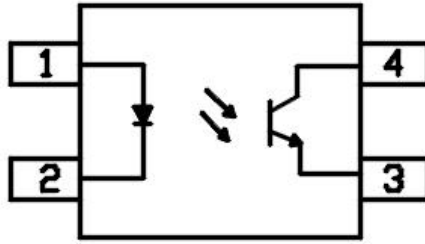
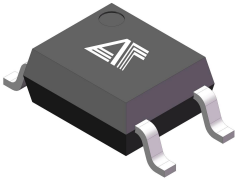

Pin Configuration

- 1. Anode
- 2. Cathode
- 3. Emitter
- 4. Collector

◆ 封装逻辑原理图 Encapsulation logic schematic

LTV-357T 系列光耦采用高效光电转换技术，结合先进封装工艺，提供输入输出间的可靠隔离，支持SOP4封装形式，适配多样化场景需求。

The LTV-357T series optocoupler adopts high-efficiency photoelectric conversion technology and advanced packaging processes, providing reliable input-output isolation. It supports package types (SOP4) to meet diverse application requirements.

◆ 产品特征 Product features

- 输入-输出隔离电压 $V_{ios}=3750V_{rms}$
Input output isolation voltage: $V_{ios}=3750 V_{rms}$
- 电流传输比CTR:80-600%范围: Current transmission ratio CTR: 80-600% range
- 集电极-发射极峰值击穿电压: $BV_{CEO}=80V$; Collector emitter peak breakdown voltage $BV_{CEO}=80V$
- 爬电距离 $>7.0mm$; Creepage distance $> 7.0mm$;
- 输入-输出绝缘距离 $>0.4mm$; Input-Output insulation Thickness $> 0.4mm$
- 防潮等级 class1; MSL class1
- 产品符合 ROHS、REACH 及 HF 等环保法规要求;
The products comply with ROHS, REACH and HF;

◆ 应用领域 Applications

- 工业控制 Industrial control
工业自动化设备 (PLC模块、传感器接口) Industrial automation equipment (PLC module, sensor interface)
测量仪器信号隔离 Measurement instrument signal isolation
- 电源系统 Power Systems:
智能电表、开关电源设计应用 Design and application of smart meters and switching power supplies
光伏逆变器、储能系统应用 Photovoltaic inverters, energy storage system applications
- 消费电子 Consumer Electronics:
家用电器主控电路 (空调、冰箱、热水器) Main control circuit for household appliances (air conditioning, refrigerator, water heater);
办公设备 (复印机) Office equipment (copier)



◆ 极限参数 Absolute Maximum Ratings (Ta = 25°C)

参数 Parameter		符号 Symbol	额定值 Rating	单位 Unit
发射端 Input	正向电流 Forward Current	IF	50	mA
	反向电压 Reverse Voltage	VR	6	V
	功耗 Power Dissipation	PD	70	mW
	额定值降低因子(在 Ta = 90°C 以上) Power dissipation Derating factor (above Ta = 90°C)	PDD	2.9	mW/°C
接收端 Output	集电极功耗 Collector Power Dissipation	PC	150	mW
	集电极电流 Collector Current	IC	50	mA
	集电极-发射极电压 Collector-Emitter Voltage	VCEO	80	V
	发射极-集电极电压 Emitter-Collector Voltage	VECO	6	V
隔离电压 Isolation Voltage		Viso	3750	Vrms
工作温度 Operating Temperature		Topr	-55 ~ +110	°C
存储温度 Storage Temperature		Tstg	-55 ~ +125	°C
焊接温度 Soldering Temperature		Tsol	260	°C

◆ 推荐操作条件 Recommended Operating Conditions

参数 Parameter	符号 Symbol	最小值 Min	最大值 Max.	单位 Unit
正向电流 Forward Current	IF	5	15	mA
集电极-发射极电压 Collector-Emitter Voltage	VCEO	5	80	V
集电极电流 Collector Current	IC	5	35	mA

◆ 产品特性参数 Product characteristic parameters (Ta =25°C)

参数 Parameter		符号 Symbol	条件 Condition	最小 Min	典型 Typ	最大 Max	单位 Unit
发射端 Input	正向电压 Forward Voltage	VF	IF=20mA	-	1.2	1.4	V
	反向电流 Reverse Current	IR	VR =4V	-	-	10	uA
	输入电容 Terminal Capacitance	Ct	V=0V, F =1KHz	-	30	250	pF
接收端 Output	集电极暗电流 Collector Dark Current	ICEO	VCE =20V	-	-	100	nA
	集电极-发射极击穿电压 Collector-Emitter Breakdown Voltage	BVCEO	IC =0.1mA, IF =0mA	80	-	-	V
	发射极-集电极电压 Emitter-Collector Voltage	BVECO	IE =10μA, IF =0	7	-	-	V
传输特性 Transfer Characteristics	电流传输比 Current Transfer Ratio	CTR	IF =5mA , VCE=5V	80	-	600	%
	集电极-发射极饱和压降 Collector-Emitter Saturation Voltage	VCE(sat)	IF =20mA, IC =1mA	-	0.1	0.2	V
	隔离电阻 Isolation Resistance	RISO	DC500V, 40 ~60%R.H.	5x10 ¹⁰	1x10 ¹¹	-	Ω
	隔离电容 Isolation capacitance	CISO	V=0,f=1MHz	-	0.6	1.0	pF
	截止频率 Cut-off Frequency	Fc	VCE=5V, IC =2mA, RL =100Ω,-3dB	-	80	-	kHz
	上升时间 Rise Time	Tr	VCE=2V, IC =2mA, RL =100Ω	-	4	18	μs
	下降时间 Fall Time	Tf	VCE=2V, IC =2mA, RL =100Ω	-	3	18	μs

注 电流传输比= $I_C/I_F \times 100\%$ 。

Note*: $CTR=I_C/I_F \times 100\%$ 。

• 电流传输比分档表 CTR Classification Table (IF = 1mA, VCE=5V, Ta =25°C)

代码Code	最小值min	最大值max
A	80	160
B	130	260
C	200	400
D	300	600

◆ 电性特性曲线 Electrical characteristic curve ($T_a = 25^\circ\text{C}$)

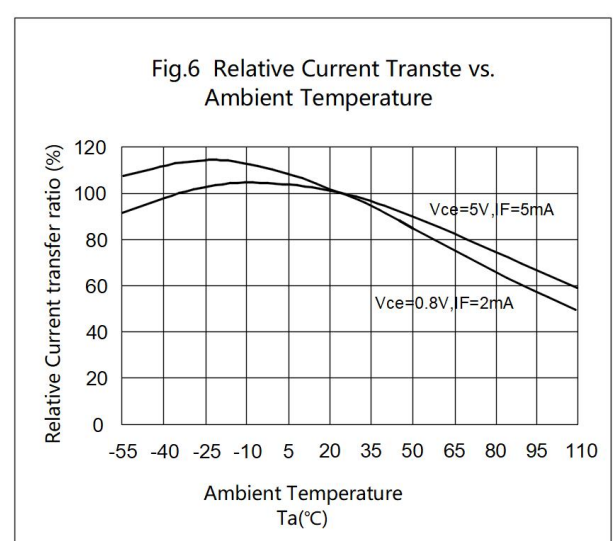
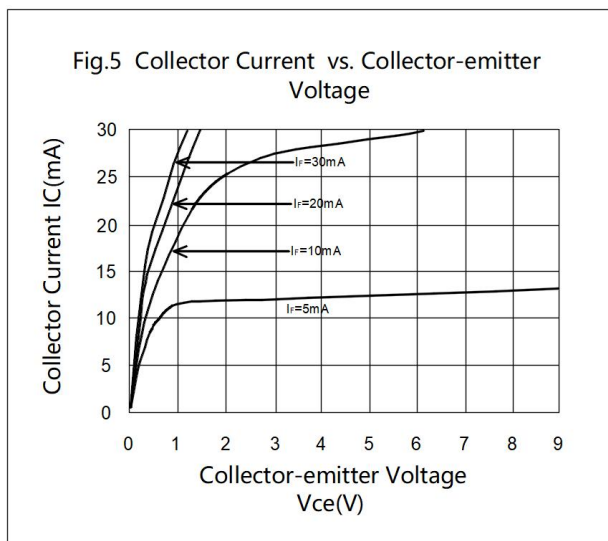
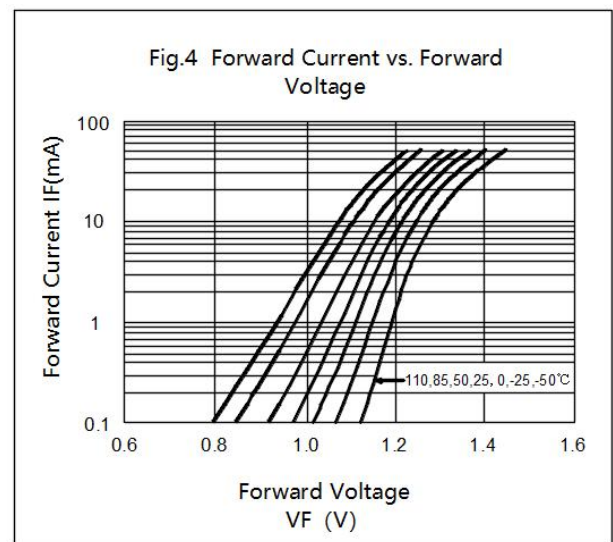
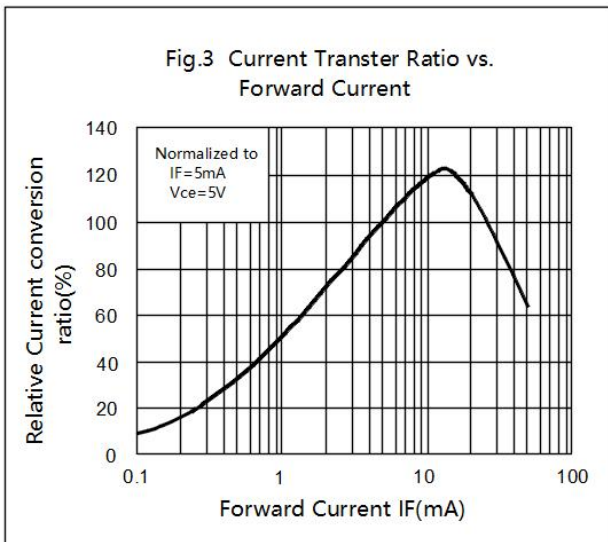
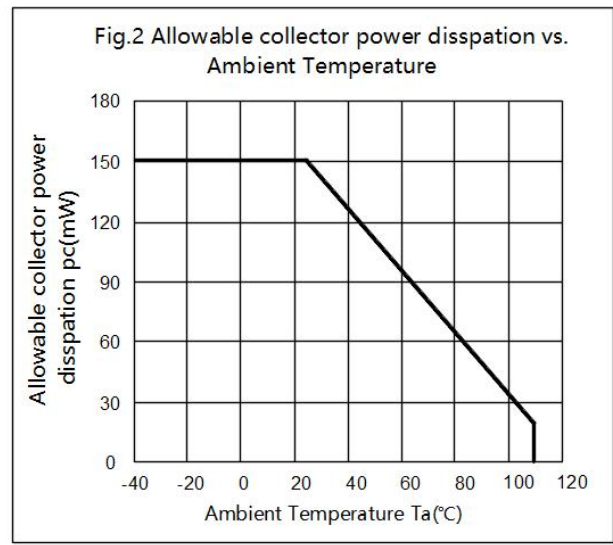
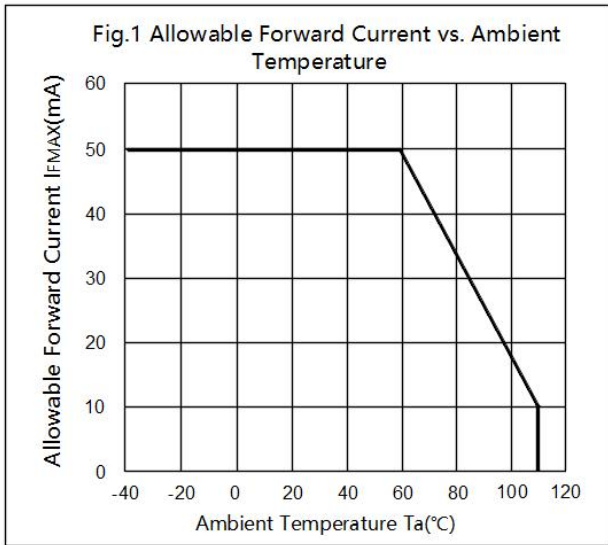

Fig.7 Collector-emitter Saturation Voltage vs. Ambient Temperature

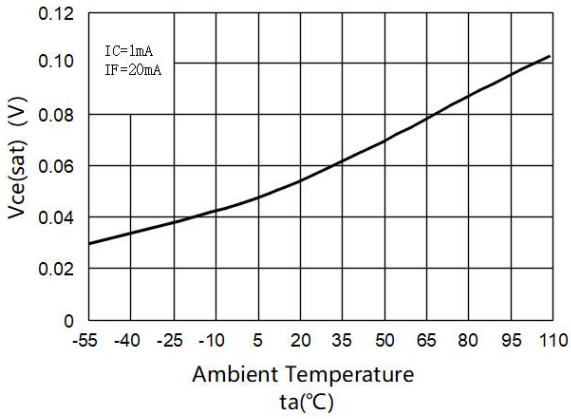

Fig.8 Collector Dark Current vs. Ambient Temperature

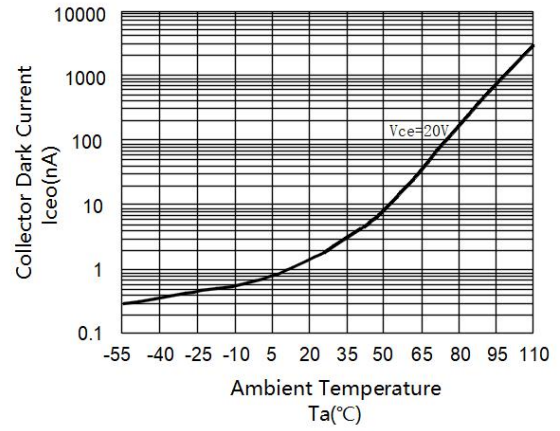

Fig.9 Response Time vs. Load Resistance

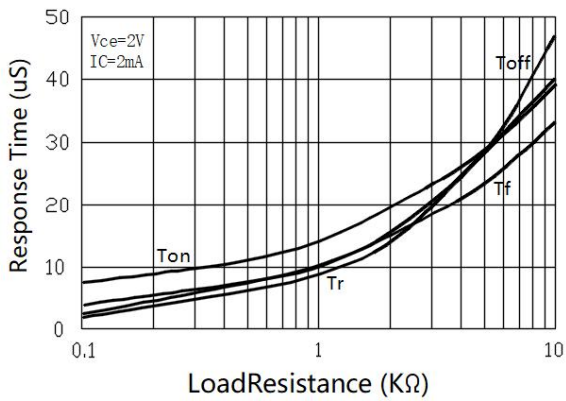

Fig.10 Frequency Response

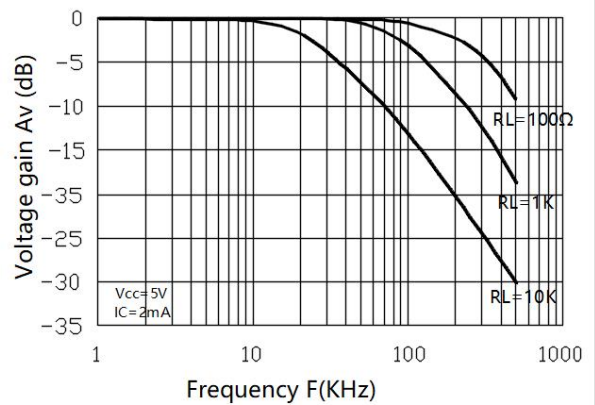

Fig.11 Collect-emitter Saturation Voltage vs. Forward Current

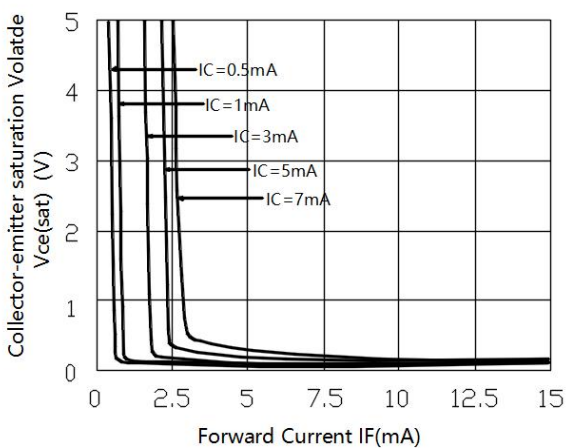
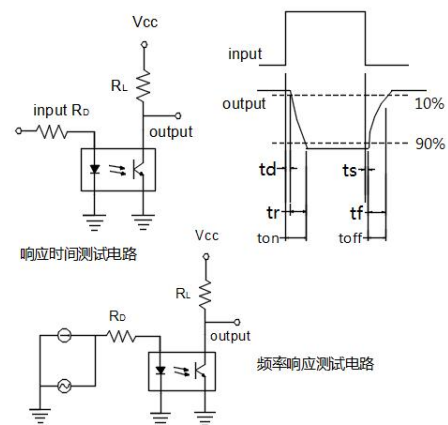
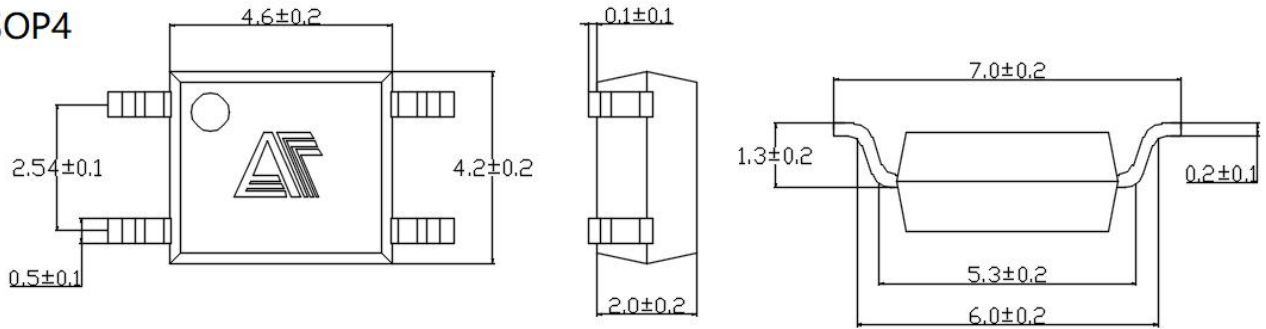

Fig.12 Switching Time Test Circuit & Waveforms



◆ 外形尺寸Overall dimension

SOP4



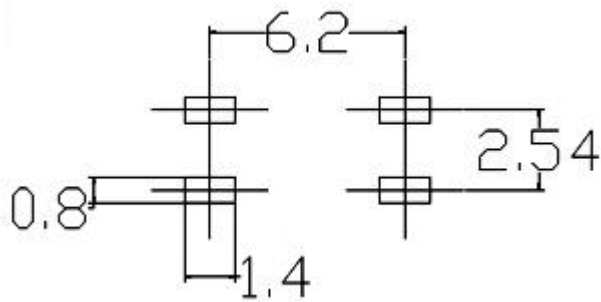

推荐焊盘:

Recommended



单位: mm

◆ **印字信息 Marking Information**

- 印字中 “  ” 为奥特品牌LOGO
“  ” denotes LOGO
- 印字中 “Y” 代表年份； A(2018),B(2019),C(2020)
“Y” denotes YEAR: A(2018), B(2019), C(2020)
- 印字中 “WW” 代表周号
“WW” denotes Week’ s number
- 印字中 “ E” 代表内部代码
“E” denotes Internal code
- 印字中的 “H” 代表无卤
“H” denotes Halogen-free



◆ **包装packing**

封装形式	包装方式	盘数量	盒数量	箱数量	静电袋规格	盒规格	箱(双瓦楞)规格	备注
SOP4	卷盘 ($\phi 330\text{mm}$ 蓝盘)	3000 只/盘	2 盘/盒	10 盒/箱	450*390*0.1mm	34*6*34cm	62*36*36.5cm	首尾端空至少 200mm
Package Type	Packing Form	Quantity per Reel	Quantity per Box	Quantity per Carton	Antistatic Bag Specification	Box Specification	Carton Specification	Note
SOP4	Reel ($\phi 330\text{mm}$ Blue)	3000 pcs /reel	2 reels /box	10 boxes /ctn	450*390*0.1mm	34*6*34cm	62*36*36.5cm	Leave at least 200mm of blank space at both ends

• **编带包装 Tape & Reel**

- 1) 每卷数量: 3000 只; Qty/reel: 3000 pcs;
- 2) 每箱数量: 60000 只; Qty/ctn: 60000 pcs;
- 3) 内包装: 每盒 2 盘; Inner packing: 2 reels/box;
- 4) 示意图 Schematic:

SOP4

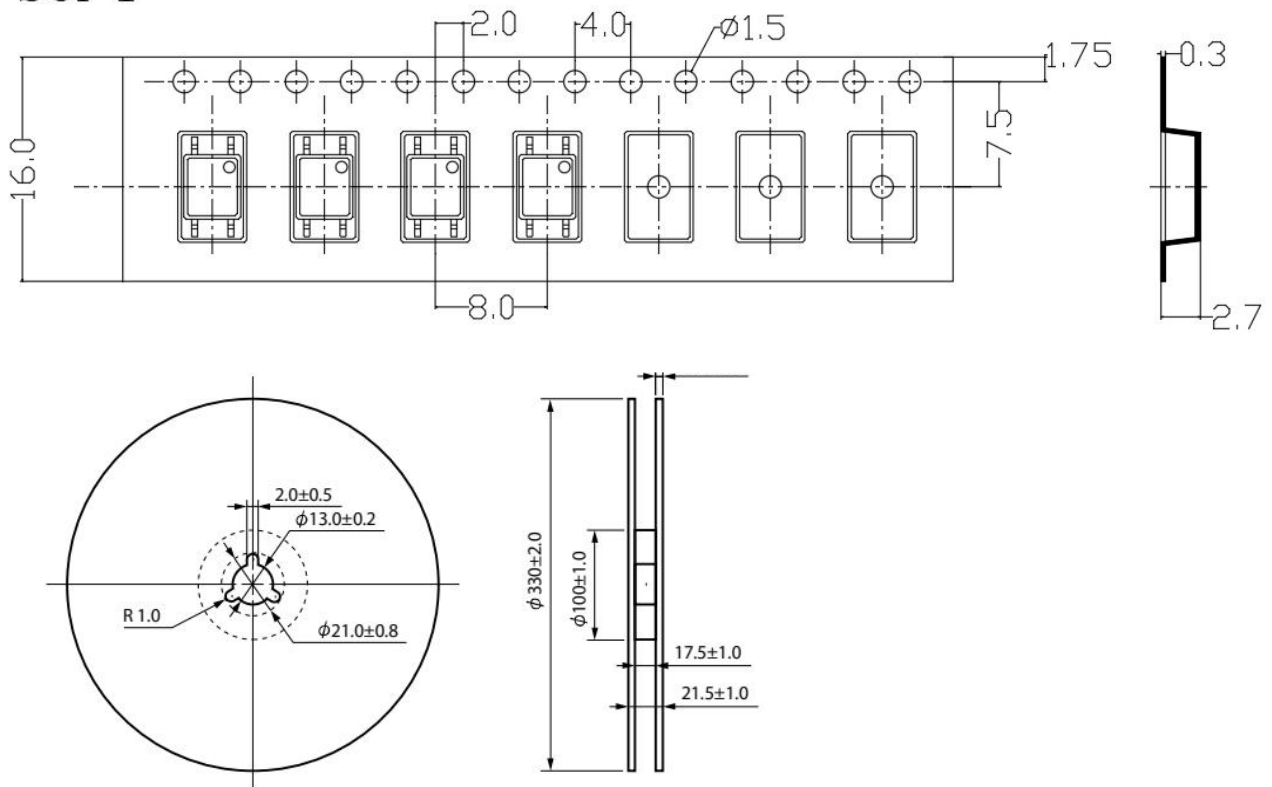

单位: mm

◆ 可靠性测试 Reliability Test Items And Conditions

实验项目 Test Items	参考标准 Reference	实验条件 Test Conditions	时间 Time	样品数 Quantity	判据 Criterion
可焊性 Solderability	JESD22-B102	Tsol= (245±5) °C, t=5s;	1 次1 times	22	0/22
耐焊接热Resistance to Soldering Heat	JESD22-A106	Tsol= (260±5) °C, t=10s	3 次3 times	22	0/22
静电放电 ESD-HBM	JESD22-A114	Ta=25°C, HBM (2000V)	正反各 3 次 P&N 3 times	10	0/10
高温贮存High emperature Storage	JESD22-A103	Ta=125°C	1000h	22	0/22
低温贮存 Low Temperature Storage	JESD22-A119	Ta= -55°C	1000h	22	0/22
冷热冲击 Thermal Shock	JESD22-A104	-55°C(15min)↔ 125°C(15min)	循环 300 次 300 cycles	22	0/22
常温寿命试验 Lifespan Test	JESD22-A108	Ta=25°C, IF=50mA , Vcc=5V	1000h	22	0/22
高温寿命试验 DC Operating Life	JESD22-A108	Ta=110°C, IF=20mA , Vcc=5V	1000h	76	0/76
高温高湿偏压 High Temperature High Humidity bias Voltage	JESD22-A101	Ta =85°C , RH=85% IF=0mA , VCE=64V	1000h	22	0/22
高温偏压 High Temperature bias Voltage	JESD22-A108	Ta =110°C , IF=0mA , VCE=80V	1000h	22	0/22
高压蒸汽试验 High pressure steam test	JESD22-A102	P=15PSIG , 121°C, 100%RH	96h	22	0/22

◆ **回流焊温度曲线图 Solder Reflow Profile**

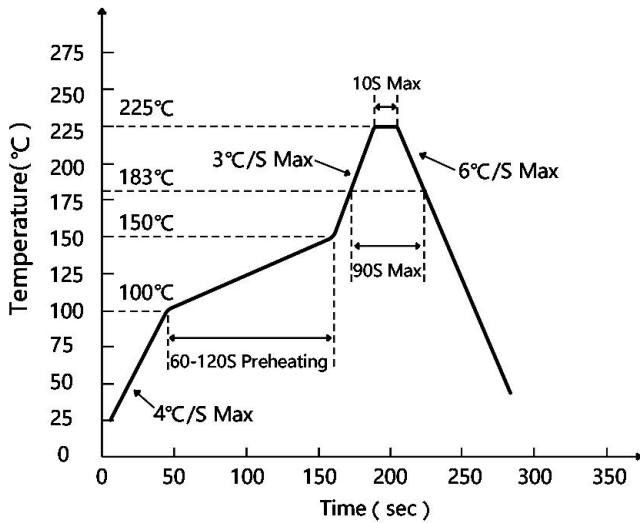

有铅制程 Lead Process

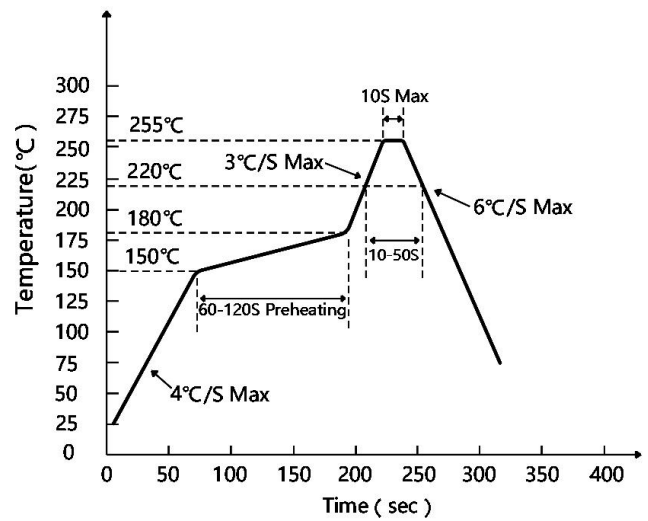

无铅制程 Lead Process

◆ **波峰焊温度曲线图 Wave Soldering Profile**

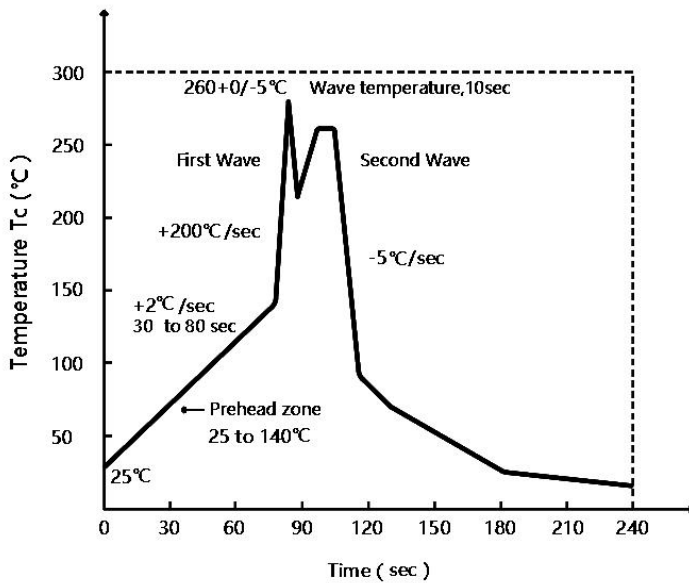

◆ **手工烙铁焊接 Soldering with hand soldering iron**

A. 手工烙铁焊仅用于产品返修或样品测试;

Hand soldering iron is only used for product rework or sample testing;

B. 手工烙铁焊要求: 温度 $350^{\circ}\text{C} \pm 5^{\circ}\text{C}$, 时间 $\leq 3\text{s}$ 。

Hand soldering iron requirements: Temperature: $350^{\circ}\text{C} \pm 5^{\circ}\text{C}$, within 3s.

◆ 注意 Attention

- 奥特半导体实施动态技术迭代机制，产品规格可能随工艺升级调整，最新技术参数以官网发布版本为准。

AOTE implements dynamic technical updates. Specifications are subject to change. Refer to the official website for the latest version.

- 用户需严格遵循本规格书限定的操作条件，因超范围使用（包括但不限于过载、高温、非兼容电路设计）导致的器件失效，不在质量保证范围内。

Users must strictly adhere to specified conditions. Failures caused by misuse (overload, high temperature, incompatible circuits) are excluded from warranty.

- 医疗设备、工业控制等关键场景应用前，需联系技术支持获取定制化验证方案。

Contact technical support for customized validation in critical applications (medical devices, industrial control).

- 本文档有效期至2025年12月31日，后续更新将通过官网公告推送。

This document is valid until Dec 31, 2025. Updates will be notified on the official website.

- 如需对技术参数或应用方案进行进一步确认，欢迎通过以下渠道获取官方支持：

For further clarification on technical specifications or application solutions, please contact us through official channels: