

2170752-1 ✓ ACTIVE

zQSFP+/QSFP28

TE Internal #: 2170752-1

QSFP28/56, Cage, Sealable, Signal, Operating Temperature Range
-40 – 85 °C [-40 – 185 °F], Data Rate (Max) 28 Gb/s, 1 Ports

[View on TE.com >](#)



Connectors > Pluggable IO Connectors & Cages



Pluggable I/O Product Type: **Cage**

Sealable: **Yes**

Circuit Application: **Signal**

Operating Temperature Range: **-40 – 85 °C [-40 – 185 °F]**

Data Rate (Max): **28 Gb/s**

Features

Product Type Features

Cage Type	Ganged
Pluggable I/O Product Type	Cage
Sealable	Yes
Form Factor	QSFP28/56

Configuration Features

Number of Rear EONs per Port Column	2
Number of Ports	1
Port Matrix Configuration	1 x 1

Electrical Characteristics

Data Rate (Max)	28 Gb/s
-----------------	---------

Contact Features

PCB Contact Termination Area Plating Material	Tin
---	-----

Termination Features

Termination Post & Tail Length	2.05 mm [.081 in]
Termination Method to PCB	Through Hole - Press-Fit

Housing Features

Cage Material	Nickel Silver
---------------	---------------



Dimensions

PCB Thickness (Recommended)	1.57 mm[.062 in]
-----------------------------	------------------

Usage Conditions

Operating Temperature Range	-40 – 85 °C[-40 – 185 °F]
-----------------------------	---------------------------

Operation/Application

Pluggable I/O Applications	SFP+ Stacked Belly-to-Belly
Heat Sink Compatible	No
Circuit Application	Signal

Industry Standards

UL Flammability Rating	UL 94V-0
------------------------	----------

Packaging Features

Packaging Method	Box & Tray
------------------	------------

Other

Included Lightpipe	No
EMI Containment Feature Type	Elastomeric Gasket

Product Compliance

[For compliance documentation, visit the product page on TE.com>](#)











EU RoHS Directive 2011/65/EU	Compliant
EU ELV Directive 2000/53/EC	Compliant
China RoHS 2 Directive MIIT Order No 32, 2016	No Restricted Materials Above Threshold
EU REACH Regulation (EC) No. 1907/2006	Current ECHA Candidate List: JUNE 2024 (241) Candidate List Declared Against: JUNE 2024 (241) Does not contain REACH SVHC
Halogen Content	Low Halogen - Br, Cl, F, I < 900 ppm per homogenous material. Also BFR/CFR/PVC Free
Solder Process Capability	Not applicable for solder process capability

Product Compliance Disclaimer

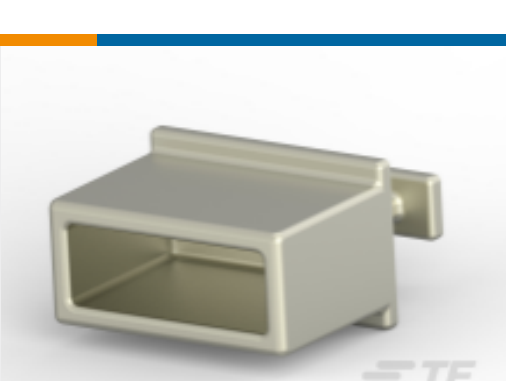

This information is provided based on reasonable inquiry of our suppliers and represents our current actual knowledge based on the information they provided. This information is subject to change. The part numbers that TE has identified as EU RoHS compliant have a maximum concentration of 0.1% by weight in homogenous materials for lead, hexavalent chromium, mercury, PBB, PBDE, DBP, BBP, DEHP, DIBP, and 0.01% for cadmium, or qualify for an exemption to these limits as defined in the Annexes of Directive 2011/65/EU (RoHS2). Finished electrical and electronic equipment products

will be CE marked as required by Directive 2011/65/EU. Components may not be CE marked. Additionally, the part numbers that TE has identified as EU ELV compliant have a maximum concentration of 0.1% by weight in homogenous materials for lead, hexavalent chromium, and mercury, and 0.01% for cadmium, or qualify for an exemption to these limits as defined in the Annexes of Directive 2000/53/EC (ELV). Regarding the REACH Regulation, the information TE provides on SVHC in articles for this part number is based on the latest European Chemicals Agency (ECHA) 'Guidance on requirements for substances in articles' posted at this URL: <https://echa.europa.eu/guidance-documents/guidance-on-reach>

Compatible Parts

 <p>TE Part # CAT-C11-Z806726 QSFP28 to QSFP28 Cable Assembly: 30 AWG</p>	 <p>TE Part # CAT-C11-N49 QSFP28-Two QSFP28 Cable Assembly: 30 AWG</p>	 <p>TE Part # CAT-C11-Z8 QSFP28 to QSFP28 Cable Assembly: 26 AWG</p>	 <p>TE Part # CAT-C11-N490333 QSFP28-Four SFP+ Cable Assembly: 30 AWG</p>
 <p>TE Part # CAT-C11-N490325 QSFP28-Four SFP+ Cable Assembly: 26 AWG</p>	 <p>TE Part # CAT-Q17-N490325 QSFP56 to QSFP56 Cable Assembly: 30 AWG</p>	 <p>TE Part # CAT-Q17-N49033 QSFP56-Two QSFP56 Cable Assembly: 30 AWG</p>	 <p>TE Part # CAT-Q17-N49011 QSFP56-Four SFP56 Cable Assembly: 30 AWG</p>
 <p>TE Part # CAT-Q17-N490333 QSFP56-Four SFP56 Cable Assembly: 26 AWG</p>	 <p>TE Part # 1888810-2 EMI/Dust Cover,XFP And QSFP</p>	 <p>TE Part # 1551920-2 zQSFP+ connector assembly</p>	 <p>TE Part # CAT-C11-Q17 QSFP56 to QSFP56 Cable Assembly: 26 AWG</p>

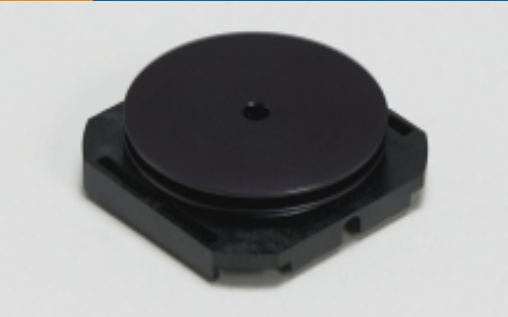
Also in the Series | zQSFP+/QSFP28

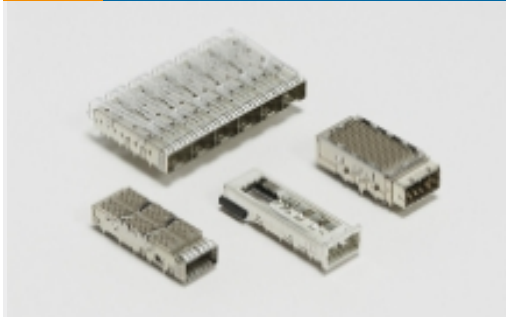
 <p>Heat Sinks(7)</p>	 <p>Pluggable I/O Cable Assemblies(78)</p>	 <p>Pluggable IO Connectors & Cages(424)</p>
--	--	---

Customers Also Bought

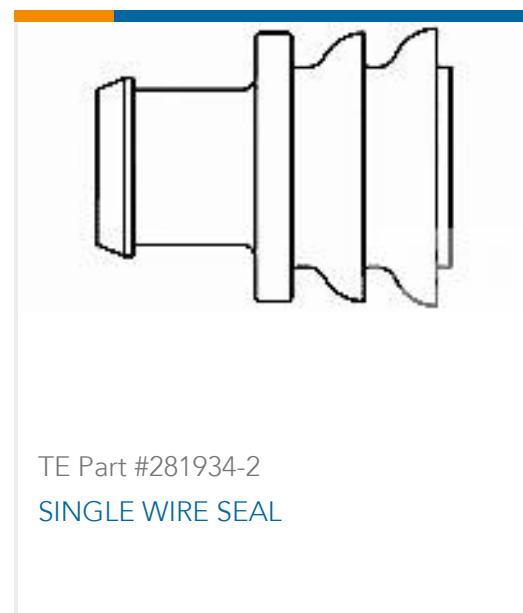

Documents

CAD Files

3D PDF

3D

Customer View Model

[ENG_CVM_CVM_2170752-1_A.2d_dxf.zip](#)

English

Customer View Model

[ENG_CVM_CVM_2170752-1_A.3d_igs.zip](#)

English

Customer View Model

[ENG_CVM_CVM_2170752-1_A.3d_stp.zip](#)

English

By downloading the CAD file I accept and agree to the [Terms and Conditions](#) of use.

Datasheets & Catalog Pages

[QSFP28/56 and zQSFP+ Interconnects](#)

English

Product Specifications

[Application Specification](#)

English