

I²S/TDM Input, 6V BOOST Digital Smart K Audio Amplifier with Speaker Current Sense

FEATURES

- **Smart BOOST with total efficiency up to 85%**
- **High RF noise suppression, eliminate the TDD noise completely**
- **Low noise: 13 μ V**
- **THD+N: 0.006%**
- **Speaker Current Sense**
- Supports 4 Ω Speaker
- Extensive Pop-Click Suppression
- Volume control (from -95.875dB to 0dB)
- I²S/TDM interface:
 - I²S, Left-Justified and Right-Justified
 - Supports 1/2/4/6/8 slots TDM
 - Input Sample Rates from 8kHz to 96kHz
 - Data Width: 16, 20, 24, 32 Bits
- Ultrasonic support via TDM/I²S running at 96kHz
- I²C-bus control interface(400kHz)
- Power Supplies:
 - VBAT: 3.0V~5.5V
 - DVDD: 1.65V~1.95V
 - VDDIO: 1.65V~3.60V
- Short-Circuit Protection, Over-Temperature Protection, Under-Voltage Protection and Over-Voltage Protection
- FC-QFN 2.0mmX2.5mmX0.55mm-22L Package

APPLICATIONS

- Mobile phones
- Tablets
- Portable Audio Devices

DESCRIPTION

The AW88266 is an I²S/TDM input, high efficiency digital Smart K audio amplifier with an integrated 6V smart boost converter. Due to its 13 μ V noise floor and ultra-low distortion, clean listening is guaranteed. It can deliver 2.0W output power into an 8 Ω speaker at 1% THD+N.

The AW88266 integrates a high-efficiency smart boost converter as the Class-D amplifier supply rail. The output voltage of boost converter can be adjusted smartly according to the input amplitude, which extremely improves the efficiency without clipping distortion.

The AW88266 features high RF suppression and eliminates TDD noise completely benefited from the digital audio input interface. General settings are communicated via an I²C-bus interface, and the device address is configurable.

The AW88266 offers Short Circuit Protection, Over-Temperature Protection, Under-Voltage Protection and Over-Voltage Protection to protect the device.

AW88266 is available in a FC-QFN 2.0mmX2.5mmX0.55mm-22L Package.

PIN CONFIGURATION AND TOP MARK

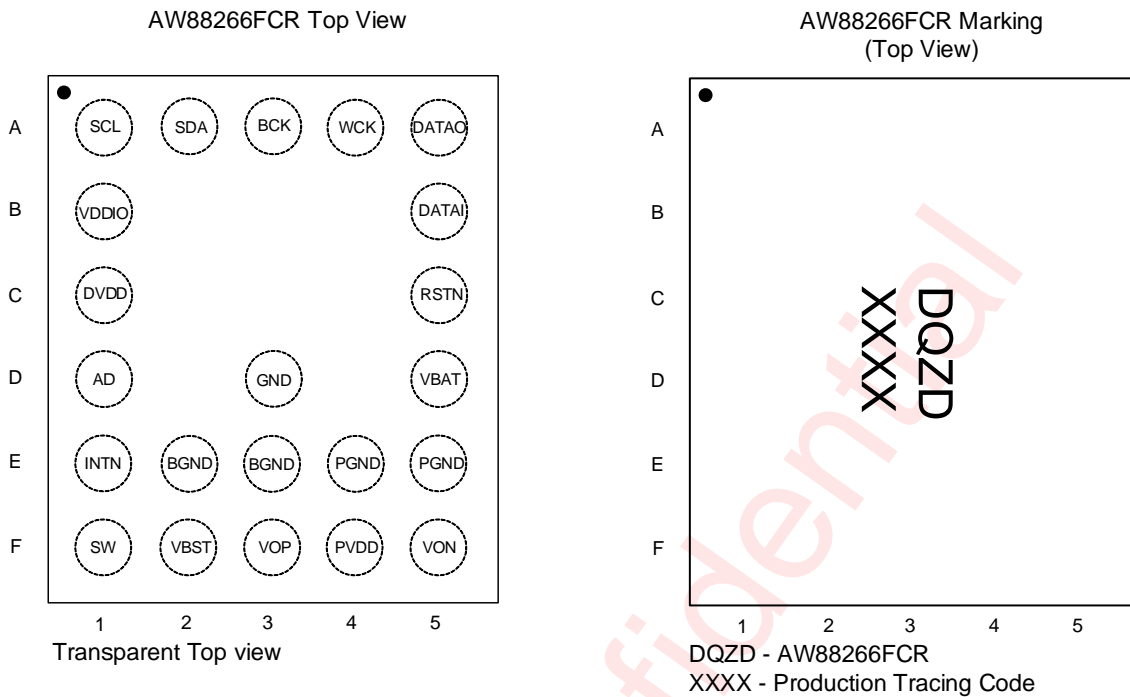

Figure 1 AW88266FCR pin diagram top view and device marking

PIN DESCRIPTION

Pin No	Pin Name	Description
A1	SCL	I ² C clock input
A2	SDA	I ² C data IO
A3	BCK	I ² S/TDM bit clock input
A4	WCK	I ² S word select input / TDM frame sync signal
A5	DATAO	I ² S/TDM data out
B1	VDDIO	Digital I/O supply voltage
B5	DATAI	I ² S/TDM data input
C1	DVDD	Digital power supply
C5	RSTN	Active low hardware reset
D1	AD	I ² C device address selection
D3	GND	GND
D5	VBAT	Battery power supply
E1	INTN	Interrupt output
E2,E3	BGND	Boost GND
E4,E5	PGND	Power GND

F1	SW	Boost switch pin
F2	VBST	Boost output
F3	VOP	Non-inverting Class-D output
F4	PVDD	Power supply voltage
F5	VON	Inverting Class-D output

awinic Confidential

FUNCTIONAL BLOCK DIAGRAM

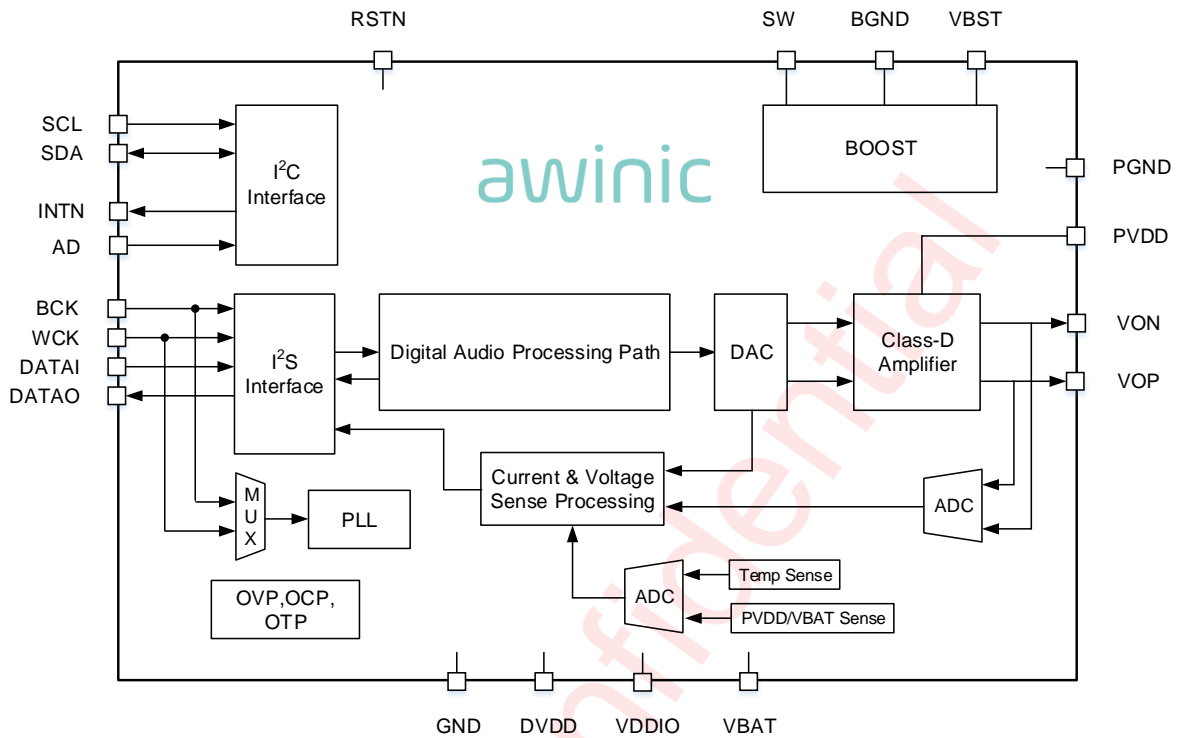

Figure 2 FUNCTIONAL BLOCK DIAGRAM

APPLICATION DIAGRAM

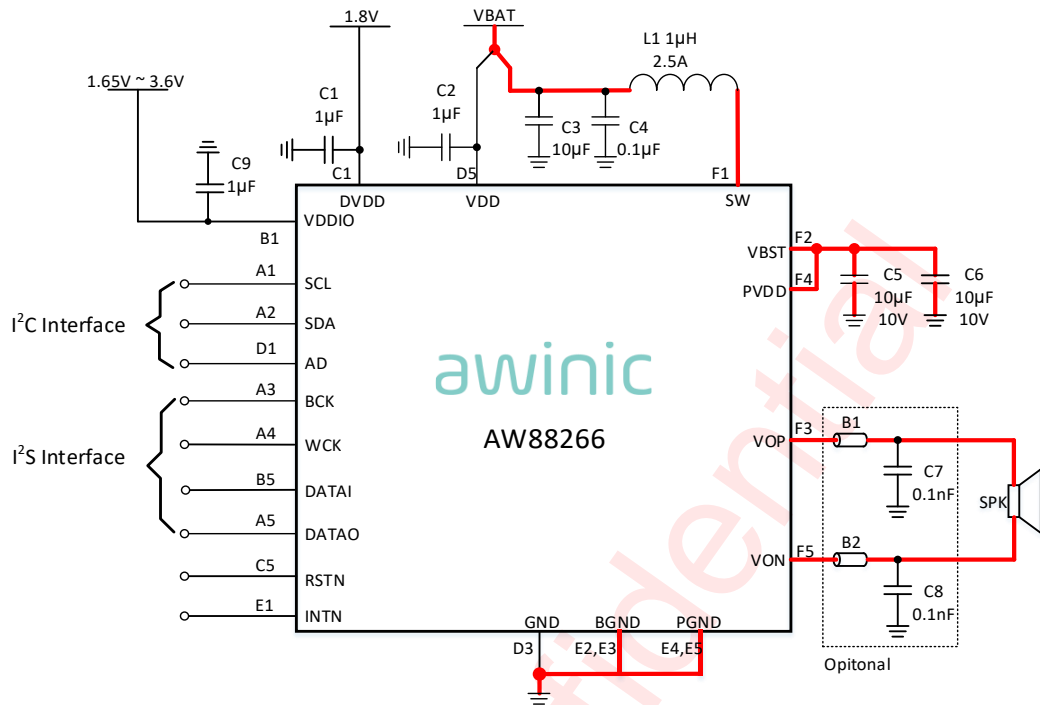

Figure 3 AW88266 Application Circuit

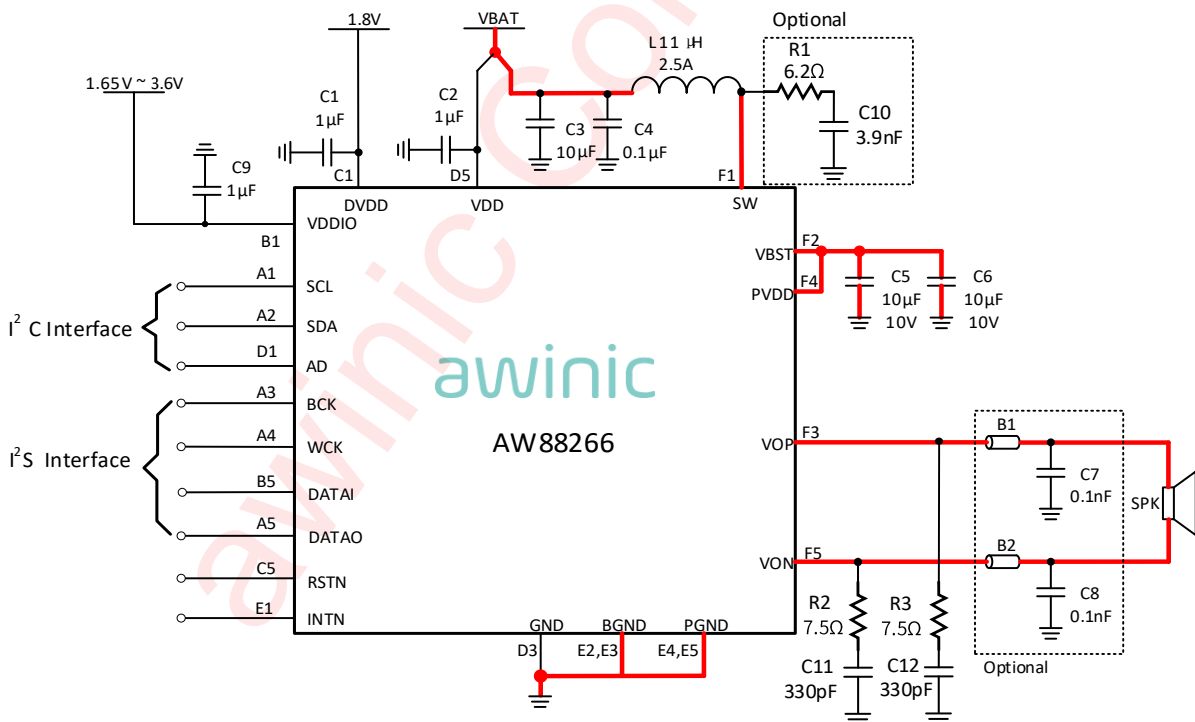

Figure 4 AW88266 Application Circuit (4Ω Load application)

Note: Traces carry high current are marked in red in the above figure

All trademarks are the property of their respective owners

ORDERING INFORMATION

Part Number	Temperature	Package	Marking	Moisture Sensitivity Level	Environmental Information	Delivery Form
AW88266FCR	-40°C~85°C	FCQFN 2mmX2.5mmX 0.55mm-22L	DQZD	MSL1	ROHS+HF	6000 units/ Tape and Reel

awinic Confidential

ABSOLUTE MAXIMUM RATING(NOTE1)

Parameter	Range
Battery Supply Voltage V_{BAT}	-0.3V to 6V
Digital Supply Voltage V_{DVDD}	-0.3V to 1.95V
Boost output voltage V_{PVDD}	-0.3 to 6.75V
Boost SW pin voltage	-0.3 to $V_{PVDD}+2V$
Minimum load resistance R_L	3.2 Ω (Note 2,3)
Package Thermal Resistance θ_{JA}	55.1 $^{\circ}C/W$
Ambient Temperature Range	-40 $^{\circ}C$ to 85 $^{\circ}C$
Maximum Junction Temperature T_{JMAX}	165 $^{\circ}C$
Storage Temperature Range T_{STG}	-65 $^{\circ}C$ to 150 $^{\circ}C$
Lead Temperature (Soldering 10 Seconds)	260 $^{\circ}C$
ESD Rating (Note 4,5)	
HBM (Human Body Model)	$\pm 2000V$
CDM (Charge Device Model)	$\pm 1500V$
MM(Machine Model)	$\pm 200V$
Latch-up	
Test Condition: JESD78E	+IT: 450mA -IT: -450mA

Note 1: Stresses beyond those listed under "absolute maximum ratings" may cause permanent damage to the device. These are stress ratings only and functional operation of the device at these or any other conditions beyond those indicated under "recommended operating conditions" is not implied. Exposure to absolute-maximum-rated conditions for extended periods may affect device reliability.

Note 2: The maximum Boost output voltage V_{PVDD} should be 5.5V when the load resistance R_L is less than 5 Ω .

Note 3: Only supports Micro Speaker when the load resistance R_L is less than 5 Ω .

Note 4: The human body model is a 100pF capacitor discharged through a 1.5k Ω resistor into each pin. Test method: ESDA/JEDEC JS-001-2017.

Note 5: Test method: ESDA/JEDEC JS-002-2018

ELECTRICAL CHARACTERISTICS

CHARACTERISTICS

Test condition: $T_A=25^{\circ}\text{C}$, $V_{BAT}=3.6\text{V}$, $DVDD=1.8\text{V}$, $VDDIO=1.8\text{V}$, $PVDD=6.0\text{V}$, $R_L=8\Omega+33\mu\text{H}$, $f=1\text{kHz}$ (unless otherwise noted)

Symbol	Description	Test Conditions	Min	Typ.	Max	Units
V_{BAT}	Battery supply voltage	On pin VBAT	3.0		5.5	V
V_{DVDD}	Digital supply voltage	On pin DVDD	1.65	1.8	1.95	V
V_{VDDIO}	Digital IO supply voltage	On pin VDDIO	1.65	1.8	3.6	V
I_{VBAT}	Battery supply current	Operating mode		3.6		mA
		Standby mode		2		μA
		Power down mode		0.3	1	μA
I_{DVDD}	Digital supply current	Operating mode		5		mA
		Standby mode		6		μA
		Power down mode		5		μA
Boost						
V_{PVDD}	Boost output voltage			6.0 ^(Note1)		V
V_{OVP}	Over-voltage threshold			$V_{PVDD}+0.5$		V
	OVP hysteresis voltage			300		mV
I_{L_PEAK}	Inductor peak current limit			2.5 ^(Note1)		A
F_{BST}	Operating Frequency	$f_s = 48\text{kHz}$		1.6		MHz
Class-D						
R_{dson}	Drain-Source on-state resistance	High side MOS + Low side MOS		350		m Ω
P_o	Speaker Output Power	THD+N=1%, $R_L=8\Omega+33\mu\text{H}$, $V_{BAT}=4.2\text{V}$, $PVDD=6.0\text{V}$		2.0		W
		THD+N=10%, $R_L=8\Omega+33\mu\text{H}$, $V_{BAT}=4.2\text{V}$, $PVDD=6.0\text{V}$		2.2		W
		THD+N=1%, $R_L=6\Omega+33\mu\text{H}$, $V_{BAT}=4.2\text{V}$, $PVDD=6.0\text{V}$		2.5		W
		THD+N=10%, $R_L=6\Omega+33\mu\text{H}$, $V_{BAT}=4.2\text{V}$, $PVDD=6.0\text{V}$		2.7		W
		THD+N=1%, $R_L=4\Omega+33\mu\text{H}$, $V_{BAT}=4.2\text{V}$, $PVDD=5.5\text{V}$		3.0		W
		THD+N=10%, $R_L=4\Omega+33\mu\text{H}$, $V_{BAT}=4.2\text{V}$, $PVDD=5.5\text{V}$		3.7		W
V_{OS}	Output offset voltage	I ² S signal input 0	-15	0	15	mV
F_{PWM}	PWM Switching frequency	Typical Sample Rate: 48kHz		384		kHz

Symbol	Description	Test Conditions	Min	Typ.	Max	Units
η	Total efficiency (Class-D)	$V_{BAT}=4.2V, P_o=0.5W, R_L=8\Omega+33\mu H$		88		%
	Total efficiency (Smart Boost + Class-D)	$V_{BAT}=4.2V, P_o=1W, R_L=8\Omega+33\mu H$		85		%
THD+N	Total harmonic distortion plus noise	$V_{BAT}=4.2V, P_o=1W, R_L=8\Omega+33\mu H, f=1kHz, PVDD=6.0V$		0.006		%
E_N	Speaker Mode Output noise	A-weighting		18		μV
	Receiver Mode Output noise	A-weighting		13		μV
FR_{amp}	Frequency response flatness (Note2)	SPK(20Hz-20kHz), $P_o=1W$		0.2		dB
		SPK(20Hz-40kHz), $P_o=1W$		0.5		dB
		RCV(20Hz-20kHz), $P_o=1W$		0.2		dB
		RCV(20Hz-40kHz), $P_o=1W$		0.5		dB
SNR	Signal-to-noise ratio	$V_{BAT}=4.2V, PVDD=6.0V, P_o=2W, R_L=8\Omega+33\mu H, A$ -weighting		107		dB
DNR	Dynamic Range	-60dBFS Method, A-weighting		106		dB
PSRR	Power supply rejection ratio	Receiver Mode, $V_{BAT}=4.2V, V_{p-p_sin}=200mV$	217Hz		85	dB
			1kHz		80	dB
Current Sense						
I_{SNS_FS}	Current sense full scale			2.5		A
SNR	Signal-to-noise ratio	$P_o=1W, R_L=8\Omega+33\mu H, A$ -weighting		65		dB
THD+N	Total harmonic distortion plus noise	$P_o=1W, R_L=8\Omega+33\mu H$		0.4		%
ΔI_{SNS}	Current sense accuracy	$P_o=1W, R_L=8\Omega+33\mu H$		2		%
Digital Logical Interface						
V_{IL}	Logic input low level	BCK, WCK, DATA Pin			$0.3 \times V_{VDDIO}$	V
V_{IH}	Logic input high level		$0.7 \times V_{VDDIO}$		V_{VDDIO}	V
V_{IL}	Logic input low level	RSTN, SCL, SDA, AD Pin			$0.3 \times V_{DVDD}$	V
V_{IH}	Logic input high level		$0.7 \times V_{DVDD}$		3.6	V
V_{OL}	Logic output low level	$I_{OUT}=2mA$			0.45	V

Symbol	Description	Test Conditions	Min	Typ.	Max	Units
V _{OH}	Logic output high level	I _{OUT} =-2mA	V _{VDDIO} - 0.45		V _{VDDIO}	V
Protection						
T _{SD}	Over temperature protection threshold			150		°C
T _{SDR}	Over temperature protection recovery threshold			130		°C
UVP	Under-voltage protection voltage			2.6		V
	Under-voltage protection hysteresis voltage			200		mV

Note 1: Registers are adjustable; Refer to the list of registers.

Note 2: FS=96kHz when the amplitude response variation is 20Hz - 40kHz.

I²C INTERFACE TIMING

No.	Sym	Parameter	MIN	TYP	MAX	UNIT
		Name				
1	f _{SCL}	SCL Clock frequency			400	kHz
2	t _{LOW}	SCL Low level Duration	1.3			μs
3	t _{HIGH}	SCL High level Duration	0.6			μs
4	t _{RISE}	SCL, SDA rise time			0.3	μs
5	t _{FALL}	SCL, SDA fall time			0.3	μs
6	t _{SU:STA}	Setup time SCL to START state	0.6			μs
7	t _{HD:STA}	(Repeat-start) Start condition hold time	0.6			μs
8	t _{SU:STO}	Stop condition setup time	0.6			μs
9	t _{BUF}	the Bus idle time START state to STOP state	1.3			μs
10	t _{SU:DAT}	SDA setup time	0.1			μs
11	t _{HD:DAT}	SDA hold time	10			ns

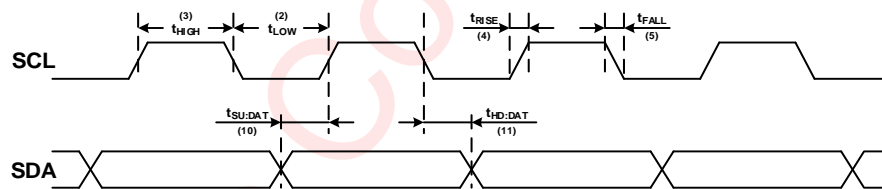

Figure 5 SCL and SDA timing relationships in the data transmission process

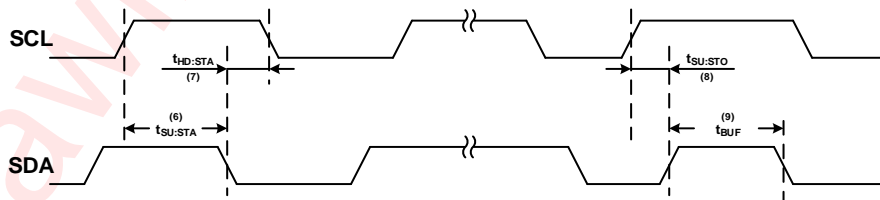

Figure 6 The timing relationship between START and STOP state

DIGITAL AUDIO INTERFACE TIMING

Parameter Name		Min	Typ.	Max	Units
f_s	sampling frequency, on pin WCK	8		96	kHz
f_{bck}	Bit clock frequency, on pin BCK	$32 \cdot f_s$		$256 \cdot f_s$	Hz
t_{su}	WCK, DATAI Setup time to BCK	10			ns
t_h	WCK, DATAI hold time to BCK	10			ns
t_d	DATAO output delay time to BCK			50	ns

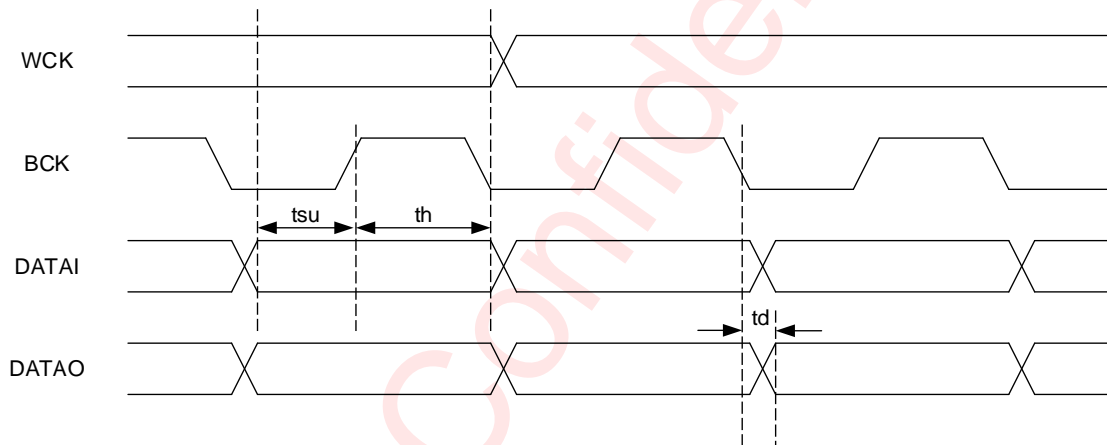
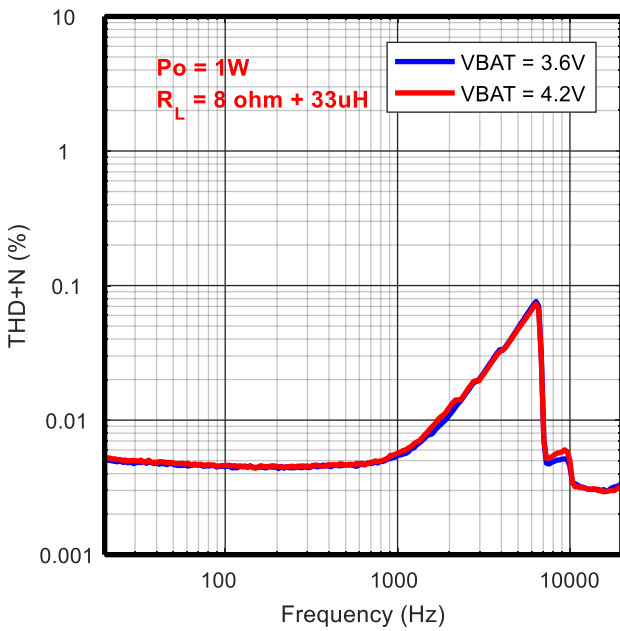

Figure 7 Digital Audio Interface Timing

TYPICAL CHARACTERISTIC CURVES

THD+N VS. FREQUENCY



THD+N VS. FREQUENCY

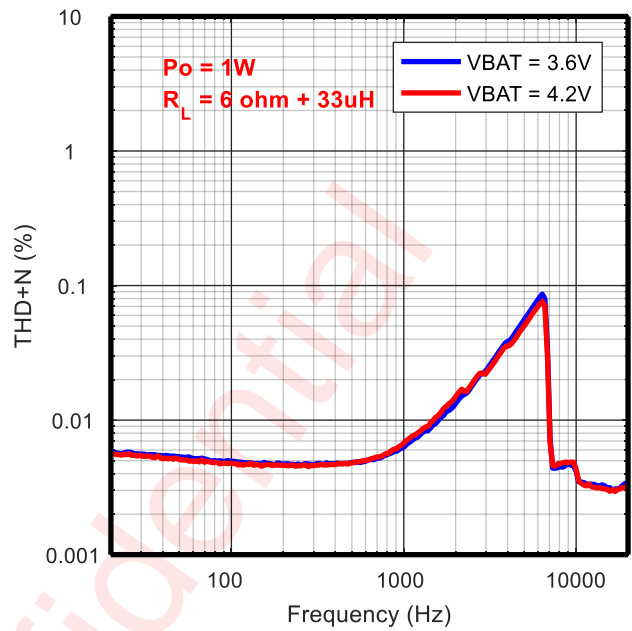

THD+N VS. FREQUENCY

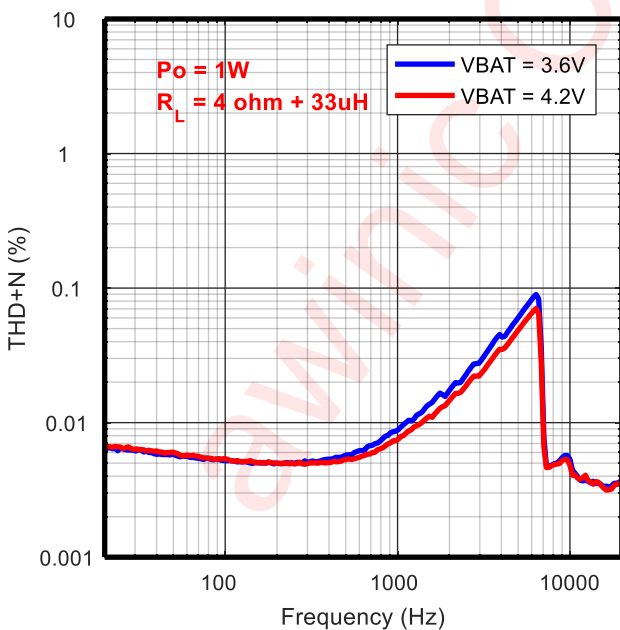

THD+N VS. OUTPUT POWER

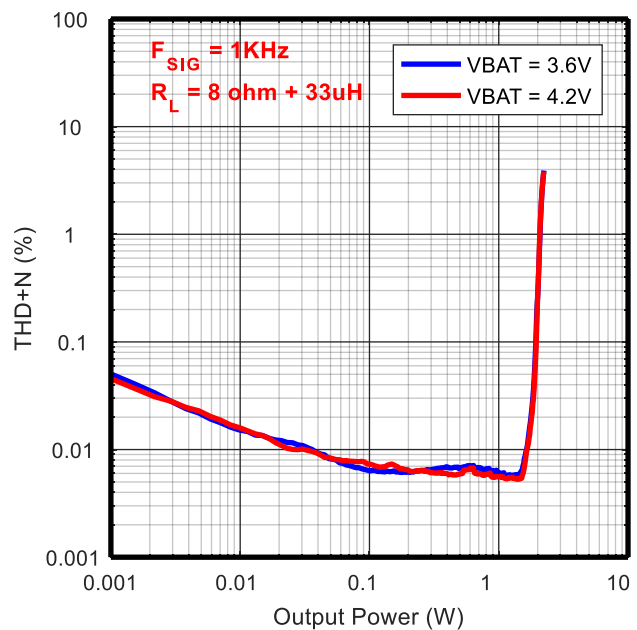

THD+N VS. OUTPUT POWER

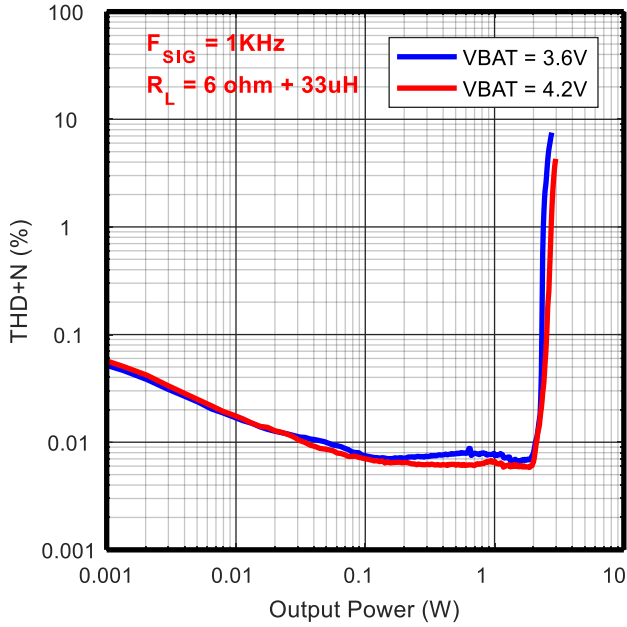

THD+N VS. OUTPUT POWER

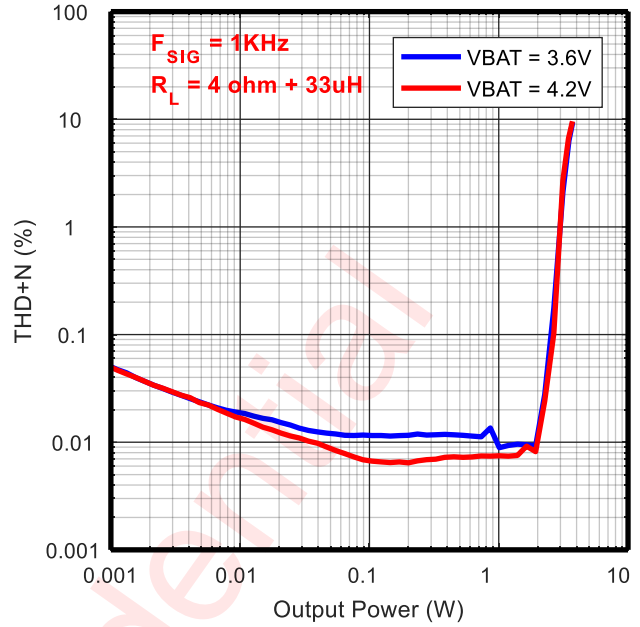

GAIN VS. FREQUENCY

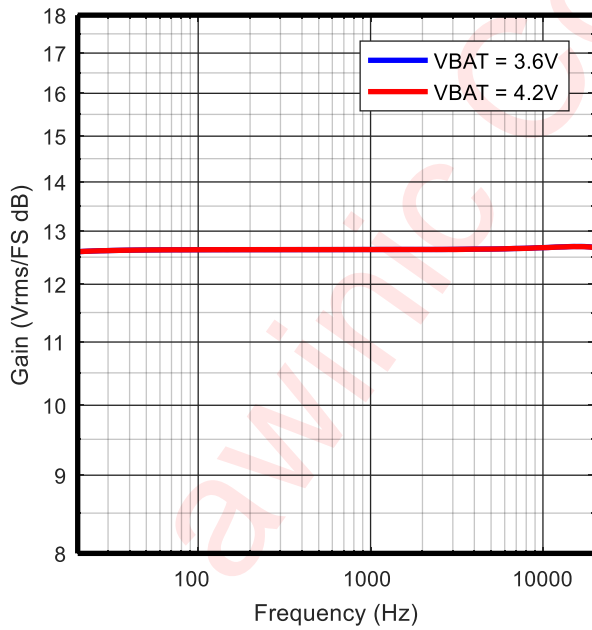

RECEIVER PSRR VS. FREQUENCY

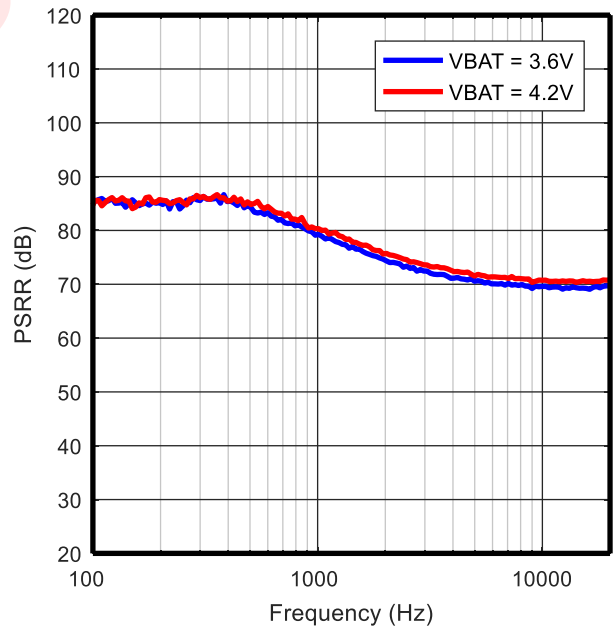

EFFICIENCY VS. OUTPUT POWER

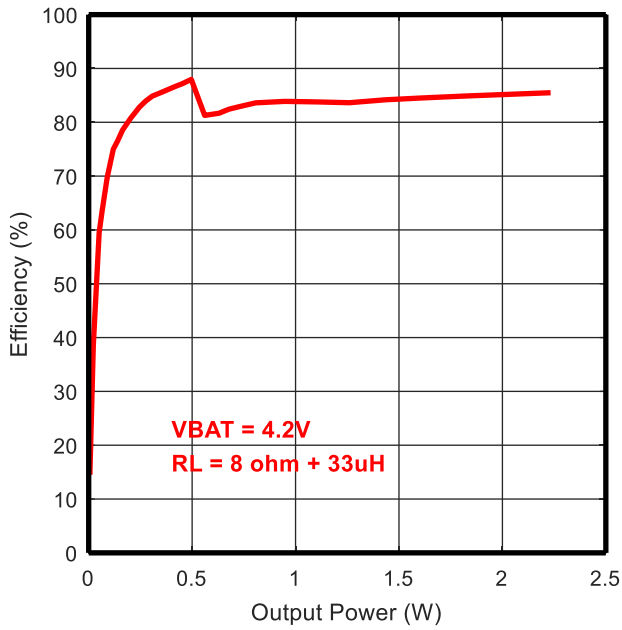

EFFICIENCY VS. OUTPUT POWER

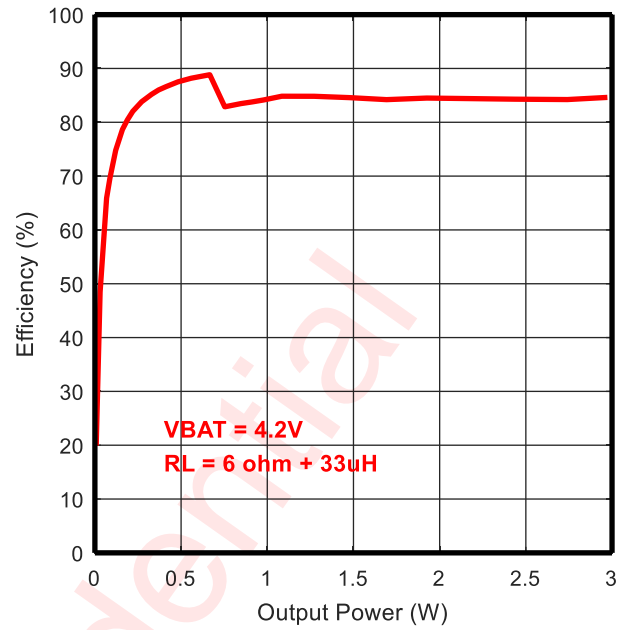

EFFICIENCY VS. OUTPUT POWER

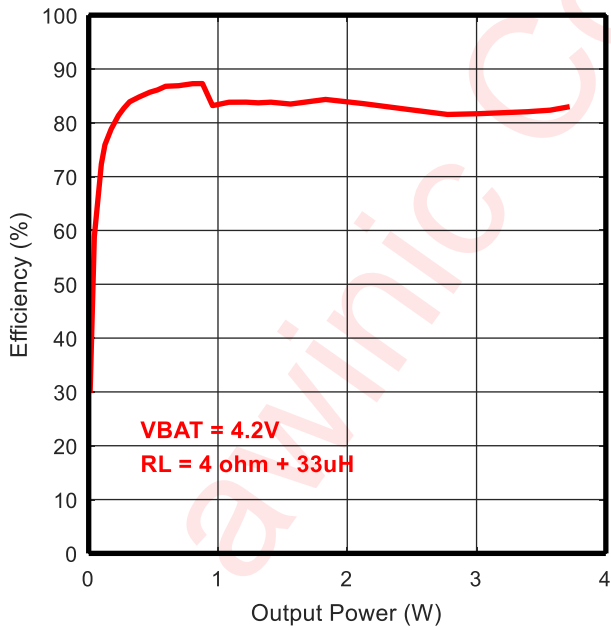

DETAIL FUNCTIONAL DESCRIPTION

POWER ON RESET

The device provides a power-on reset feature that is controlled by VBAT and DVDD supply voltage. When the VBAT supply voltage raises from 0V to 2.1V, or DVDD supply voltage raises from 0V to 1.1V. The reset signal will be generated to perform a power-on reset operation, which will reset all circuits and configuration registers.

OPERATION MODE

The device supports 4 operation modes.

Table 1 Operating Mode

Mode	Condition	Description
Power-Down	$V_{BAT} < 2.1V$ $V_{DVDD} < 1.1V$	Power supply is not ready, chipset is power down.
Stand-By	$V_{BAT} > 3.0V$ $V_{DVDD} > 1.65V$	Power supply is ready, most parts of the device are power down for low power consumption except I ² C interface
Configuring	PWDN = 0	Device is biased while boost and class-D output is floating. System configuration carried out in this mode
Operating	AMPPD = 0	Amplifier is fully operating

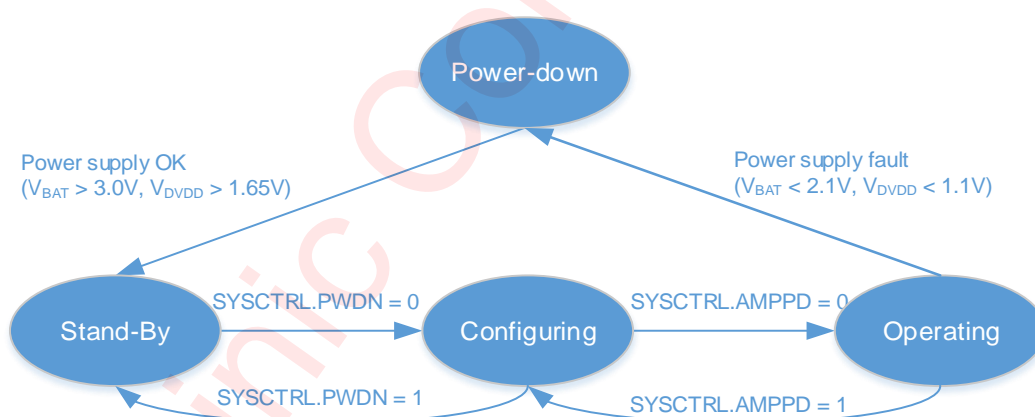

Figure 8 Device operating modes transition

POWER-DOWN MODE

The device switches to power-down mode when any of the following events occurred:

- $V_{DVDD} < 1.1V$
- $V_{BAT} < 2.1V$
- RSTN pin goes LOW

In this mode, all circuits inside this device will be shut down except the power-on-reset circuit. I²C interface isn't accessible in this mode, and all of the internal configurable registers are cleared.

The device will jump out of the power-down mode automatically when all of the supply voltages are OK:

$V_{DVDD} > 1.65\text{ V}$ and $V_{BAT} > 3.0\text{ V}$
And RSTN goes HIGH.

STAND-BY MODE

The device switches stand-by mode when the power supply voltages are OK and RSTN pin is HIGH. In this mode I²C interface is accessible, other modules are still powered down. Customer can set device to mode when the device is no needed to work.

CONFIG MODE

The device switches to OFF mode when:

- SYSCTRL.PWDN = 0;
- SYSCTRL.AMPPD = 1;

In this mode the internal bias, OSC, PLL will start to work

OPERATING MODE

The device is fully operational in this mode. Boost, amplifier loop and power stage circuits will start to work. Customer can set SYSCTRL.AMPPD = 0 to make device in this mode.

This device power up sequence is illustrated in the following figure:

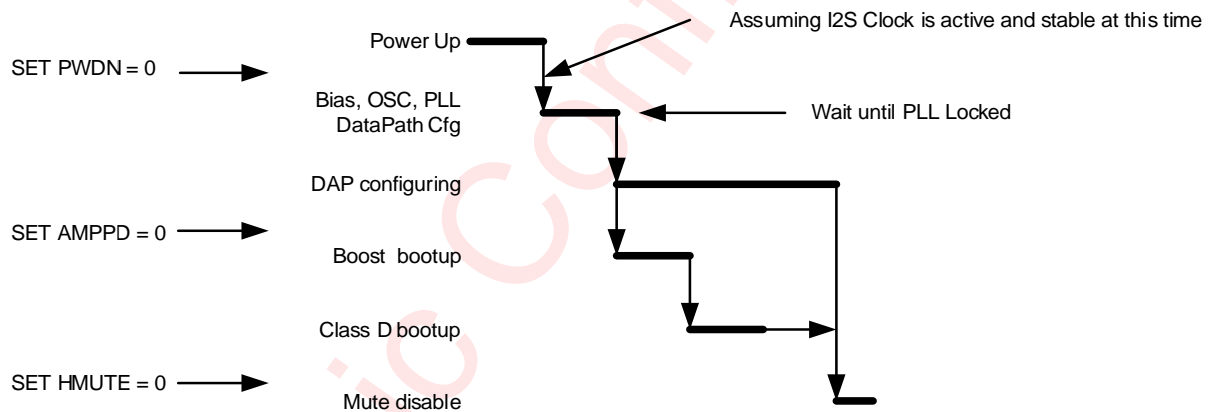

Figure 9 Power up sequence

Detail description for each step is listed in the following table.

Table 2 Detail Description of Power up sequence

Index	Description	Mode
1	Wait for VBAT, VDDIO, DVDD supply power up	Power-Down
2	I ² S + Data Path Configuration	Stand-By
3.1	Enable system (SYSCTRL.PWDN = 0)	Configuring
3.2	Bias, OSC, PLL active	
3.3	Waiting for PLL to be locked	
4.1	Enable Boost and amplifier (SYSCTRL.AMPPD = 0) Boost and Amplifier boot up	Operating
4.2	Waiting for SYSST.SWS = 1	
5	Release Hard-Mute Data Path active	

Power up sequence considering I²S, I²C timing shows as below:

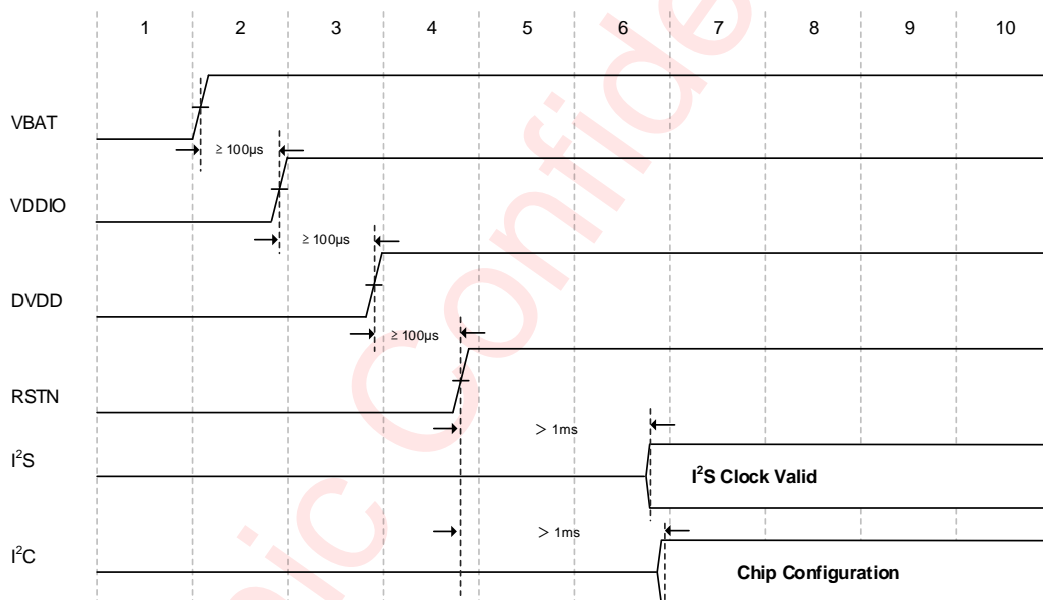

Power down sequence considering I²S, I²C timing shows as below:

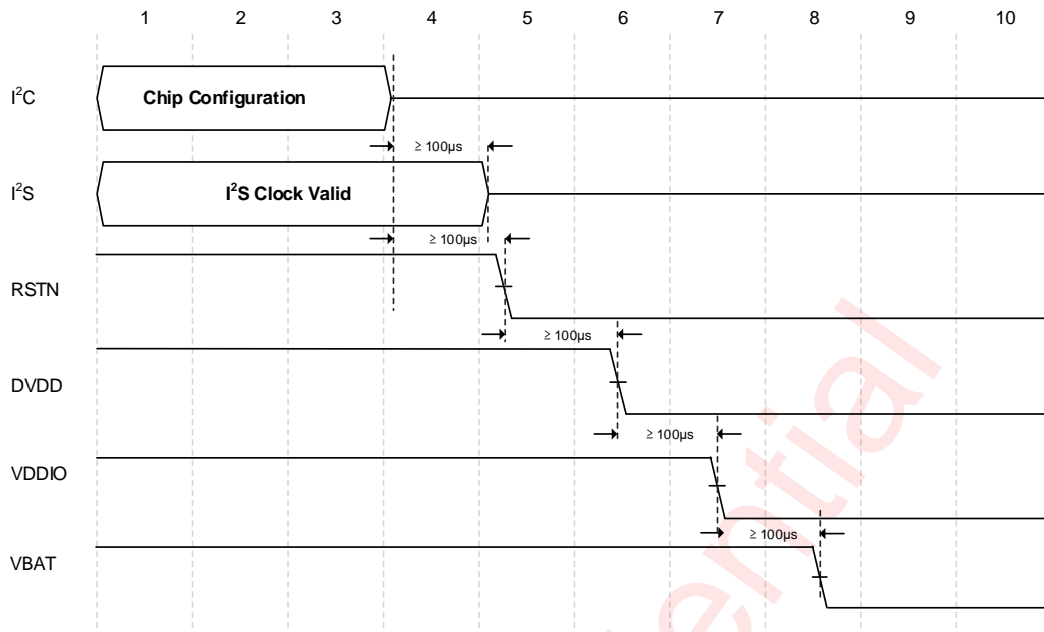

SOFTWARE RESET

Writing 0x55AA to register ID (0x00) via I²C interface will reset the device internal circuits and all configuration registers.

DIGITAL I/O STATUS

Each digital input and IO's state is shown in below table. The input signal pin BCK, WCK and DATAI are set to high impedance by default after power on. If I2STXEN is enabled, DATAO is actively driven when outputting data otherwise it is high impedance by default.

Digital I/O	Type	Description (Default state)
RSTN	Input	Weak pull down
SCL	Input	Hi-Z
SDA	Inout	Hi-Z
INTN	Output	Hi-Z
AD	Input	Weak pull down (RSTN = High)
BCK	Input	Hi-Z
WCK	Input	Hi-Z
DATAI	Input	Hi-Z
DATAO	Output	Hi-Z

DIGITAL AUDIO INTERFACE

Audio data is transferred between the host processor and the device via the Digital Audio Interface. The digital audio interface is in full-duplex via 4 dedicated pins:

- BCK
- WCK

- DATAI
- DATAO

Two-slot I²S and 1/2/4/6/8-slot TDM are supported in this device. The digital audio Interface on this device is slave only and flexible with data width options, including 16, 20, 24, or 32 bits by configurable registers.

Three modes of I²S are supported, including standard I²S mode, left-justified mode and right-justified data mode, which can be configured via I2SCTRL1.I2SMD. These modes are all MSB-first, with data width programmable via I2SCTRL1.I2SFS.

The word clock WCK is used to define the beginning of a frame. The frequency of this clock corresponds to the sampling frequency. The device supports the following sample rates (fs): 8kHz, 11.025kHz, 12kHz, 16kHz, 22.05kHz, 24kHz, 32kHz, 44.1kHz, 48kHz and 96kHz. It is selected via configurable register I2SCTRL1.I2SSR.

The bit clock BCK is used to sample the digital audio data across the digital audio interface. The number of bit-clock pulses in a frame is defined as slot length. Three kind of slot length are supported (16/24/32) via configurable register I2SCTRL1.I2SBCK. The frequency of BCK can be calculated according to the following equation:

$$BCK \text{ frequency} = \text{SampleRate} * \text{SlotLength} * \text{SlotNumber}$$

SampleRate: Sample rate for this digital audio interface;

SlotLength: The length of one audio slot in unit of BCK clock;

SlotNumber: How many slots supported in this audio interface. For example: 2-slot supported in I²S mode, 1/2/4/6/8-slot supported in TDM mode.

The word select and bit clock signals of the I²S input are the reference signals for the digital audio interface and Phased Locked Loop (PLL).

The audio source can be from left channel, right channel or the average of the left and right channel, which is controlled by I2SCTRL1.CHSEL.

Table 3 Supported I²S interface parameters

Interface format(MSB first)	Data width	BCK frequency
Standard I ² S	16b/20b/24b/32b	32fs/48fs/64fs
Left-justified	16b/20b/24b/32b	32fs/48fs/64fs
Right-justified	16b/20b/24b/32b	32fs /48fs/64fs

The output port DATAO, can be enabled or disabled via bit I2SCTRL1.I2STXEN. The unused slots can be set to Hi-z or normal working, which is controlled by SYSCTRL2.DOHZ.

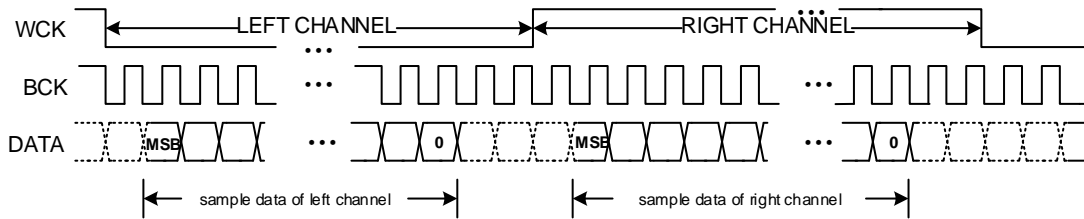
STANDARD I²S MODE**Figure 10 I²S Timing for Standard I²S Mode**

- When WCK=0 indicating the left channel data, and WCK=1 indicating the right channel data.
- The MSB of the left channel is valid on the second rising edge of the bit clock after the falling edge of the word clock. Similarly the MSB of the right channel is valid on the second rising edge of the bit clock after the rising edge of the word clock.

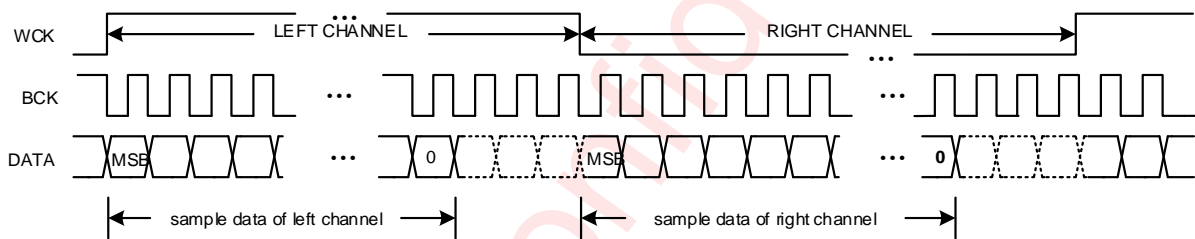
LEFT-JUSTIFIED MODE**Figure 11 I²S Timing for Left-Justified Mode**

- When WCK=1 indicating the left channel data, and WCK=0 indicating the right channel data.
- The MSB of the left channel is valid on the first rising edge of the bit clock after the rising edge of the word clock. Similarly the MSB of the right channel is valid on the first rising edge of the bit clock after the falling edge of the word clock.

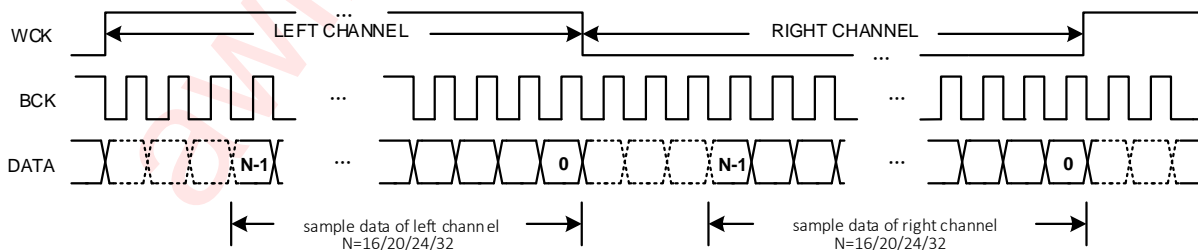
RIGHT-JUSTIFIED MODE**Figure 12 I²S Timing for Right-Justified Mode**

- When WCK is high indicating the left channel data, and WCK=0 indicating the right channel data.
- The LSB (bit 0) of the left channel is valid on the rising edge of the bit clock preceding the falling edge of the word clock. Similarly, the LSB (bit 0) of the right channel is valid on the rising edge of the bit clock

preceding the rising edge of the word clock.

TDM MODE

All of the three kind of bit synchronization modes (standard, left-justified, right-justified) are also supported in TDM mode. The difference between TDM and I²S is the slot number supported. 1/2/4/6/8-slot is supported in TDM mode, while 2-slot is supported in I²S mode

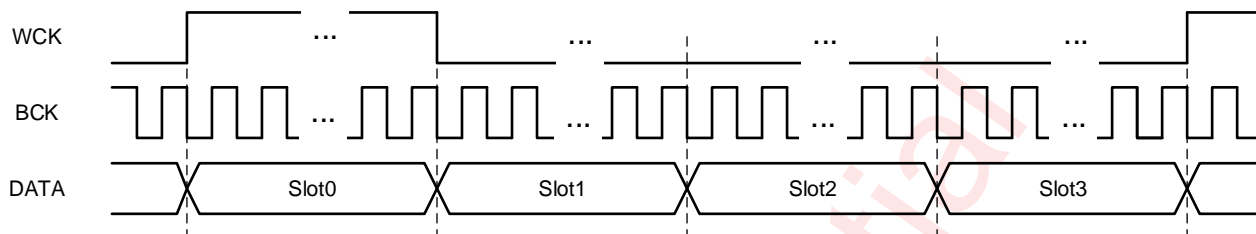

Figure 13 TDM Timing

Note: The high level pulse width of WCK signal can be one slot time or one period of BCK.

DIGITAL AUDIO PROCESSING

This device incorporates one programmable Digital Audio Processor (DAP) block. It provides the algorithm for audio signal processing and speaker protection. The following functions are available in this module.

- HDCC
- Hardware AGC
- Volume control
- Mute

The signal processing flow in the Digital Audio Processor (DAP) is illustrated in the following figure.

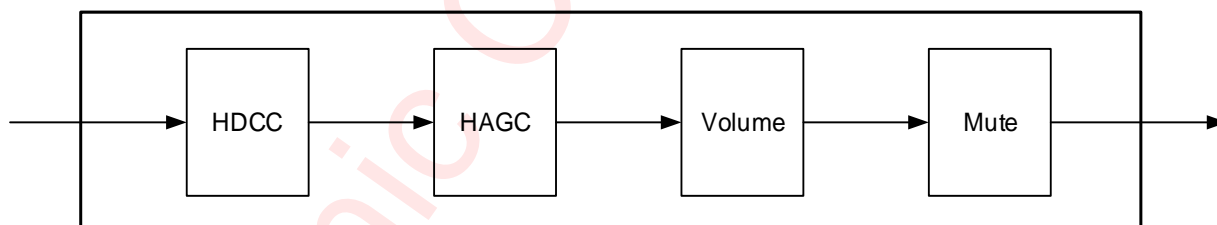

Figure 14 Block Diagram of DAP

HDCC

This module performs hardware DC canceling for the input audio stream. It blocks DC components into analog class D loop.

HAGC

System output power tends to be more than rated power of speaker in the actual audio application, such as the maximum undistorted power is about 2.0W in the 6.0V power supply for 8Ω speaker. However, many speakers' rated power is about 1W, the overload signal can cause damage to the speaker if there is no output power control. The audio power amplifier with HAGC can protect the speaker effectively. When the output power does

not exceed the setting threshold, the HAGC module will not attenuate the internal gain. Once the output power exceeds the setting threshold, the HAGC module will reduce the internal gain of amplifier and restrict the output power under the setting threshold.

VOLUME CONTROL

The volume control function attenuates the audio signal at the end of digital audio processing. The range of volume setting is from 0dB to -95.875dB with 0.125dB/step.

MUTE

This module performs mute control for the audio stream.

DC-DC CONVERTER

This device using smart boost converter generates the amplifier supply rail, working in 1.6MHz. The DC-DC converter can work in different mode via BSTCTRL2.BST_MODE:

- **Pass-through mode:** the voltage of VBAT is transparently passed to output of converter PVDD
- **Force boost mode:** the output voltage is boosted to the programmed output voltage
- **Smart boost 1 mode:** the output voltage can be switch between VBAT and programmed output voltage according to the amplifier output's signal swing requirements.
- **Smart boost 2 mode:** the output voltage can be dynamically adjusted according to the amplifier output's signal swing requirements in order to maximize efficiency of smart boost 2.

PASS-THROUGH MODE

The internal boost circuit is not working; the voltage of VBAT is passed to PVDD directly.

FORCE BOOST MODE

The boost circuit is always working and converts the voltage of VBAT to the programmed output voltage. The output voltage is configured via BSTCTRL2.VOUT_VREFSET

SMART BOOST 1 MODE

Smart boost 1 mode can dynamically turn off the boost according to the amplifier output's signal swing requirements in order to maximize efficiency.

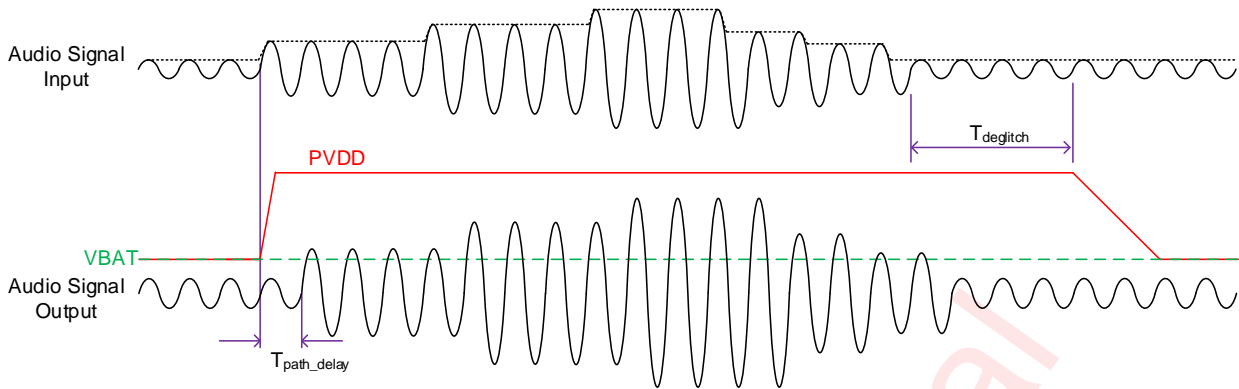

Figure 15 Boost Circuit Behavior in Smart Boost 1 Mode

SMART BOOST 2 MODE

The boost circuit works dynamically according to the output audio level. When the level of output audio signal is below the setting threshold, the boost circuit will not be activated. Till the level of output audio signal is above the threshold, the boost circuit starts to work before the audio stream arriving at amplifier power stage. The output voltage PVDD is dynamically adjusted to meet the amplifier output's signal swing requirements.

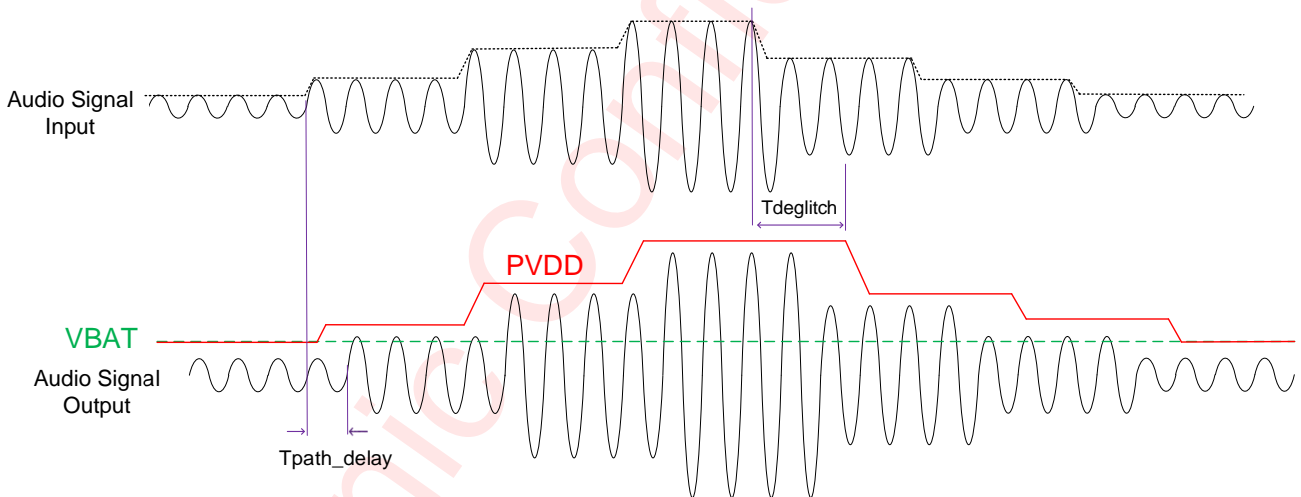

Figure 16 Boost Circuit Behavior in Smart Boost 2 Mode

NOTE: When the voltage of VBAT is higher than 5V, DC-DC converter should be worked in Pass-through mode.

PROTECTION MECHANISMS

Over Voltage Protection (OVP)

The boost circuit has integrated the over voltage protection control loop. When the output voltage PVDD is above the threshold, the boost circuits will stop working, until the voltage of PVDD going down and under the normal fixed working voltage.

Over Temperature Protection (OTP)

The device has automatic temperature protection mechanism which prevents heat damage to the chip. It is triggered when the junction temperature is larger than the preset temperature high threshold (default = 150°C). When it happens, the output stages will be disabled. When the junction temperature drops below the preset temperature low threshold (less than 130°C), the output stages will start to operate normally again

Over Current (short) Protection (OCP)

The short circuit protection function is triggered when VOP/VON is short to PVDD/GND or VOP is short to VON, the output stages will be shut down to prevent damage to itself. When the fault condition is disappeared, the output stages of device will restart.

Under Voltage Detection (UVL)

The interrupt bit SYSINT.UVLI will be set to 1 when VBAT under voltage occurs, and SYSINT.UVLDI will be set to 1 when DVDD under voltage occurs. Both interrupt bits will be cleared by a read operation of SYSINT register. Usually the SYSINT.UVLI and SYSINT.UVLDI bit can be used to check whether an unexpected under-voltage event has taken place.

BATTERY VOLTAGE MONITORING

The device monitors the voltage on the VBAT pin, which is most commonly the battery for the system. The battery voltage level is available via bits VBAT_DET in the Battery Supply Voltage register VBAT. Status bits VBAT_DET can be used to calculate the battery voltage. The battery voltage level V_{BAT} is:

$$V_{BAT} = \frac{VBAT_DET}{2^{10} - 1} \times 6.025V$$

For example, if VBAT_DET = 1001100011, the battery voltage level V_{BAT} is equal to 3.6V.

PVDD VOLTAGE MONITORING

The device monitors the voltage on the PVDD pin, which is most commonly the PVDD voltage level for the system. The PVDD pin voltage level is available via bits PVDD_DET in the Power Supply Voltage monitor register PVDD. Status bits PVDD_DET can be used to calculate the PVDD voltage. The PVDD voltage level V_{PVDD} is:

$$V_{PVDD} = \frac{PVDD_DET}{2^{10} - 1} \times 7.25V$$

For example, if PVDD_DET = 1001100011, the PVDD voltage level V_{PVDD} is equal to 4.3V.

DIE TEMPERATURE MONITORING

The device monitors the die temperature and the result is available via bits TEMP_DET in the Temperature register TEMP. The TEMP_DET is a two's complement value. For example, if TEMP_DET = 00011001, the die temperature is 25°C.

CURRENT SENSING

The device provides speaker current sense for real time monitoring of loudspeaker behavior. Current sensing is not disturbed by capacitance (<1nF) on the output lines or on the long speaker tracks. The current sensing transfer function I_{SNS} is:

$$I_{SNS} = \frac{D_{OUT}}{2^{15} - 1} \times 2.5A$$

D_{OUT}: the current sense I²S output stream

AMPLIFIER TRANSFER FUNCTION

The transfer function from the input to the amplifier PWM output (when no gain and attenuation is applied in digital signal domain) is:

$$V_o = AMP_NORM_V \times D_{in}$$

D_{in}: the level of input signal with a range from -1 to +1

AMP_NORM_V: the equivalent amplifier output voltage when D_{in} is 1. In receiver mode the AMP_NORM_V is 4.5V, in speaker mode it's 6.7V.

RECEIVER MODE

The device built-in Receiver mode is easy to realize the Speaker and Receiver combo applications, it saves the system cost and board space. If the receiver magnification is one times, the noise floor will be 13μV. Speaker and Receiver combo applications can be realized without changing any hardware.

When the device is set to receiver mode, the power supply of Class D driver stage is from VBAT directly without boost.

I²C INTERFACE

This device supports the I²C serial bus and data transmission protocol in fast mode at 400kHz. This device operates as a slave on the I²C bus. Connections to the bus are made via the open-drain I/O pins SCL and SDA. The pull-up resistor can be selected in the range of 1k~10kΩ and the typical value is 4.7kΩ. This device can support different high level (1.8V~3.3V) of this I²C interface.

DEVICE ADDRESS

The I²C device address (7-bit) can be set using the AD pin according to the following table: The AD pin configures the two LSB bits of the following 7-bit binary address A6-A0 of 01101xx. The permitted I²C addresses are 0x34 (7-bit) through 0x37 (7-bit).

Table 4 Address Selection

AD	Address(7-bit)
GND	0x34
DVDD	0x35
SCL	0x36
SDA	0x37

DATA VALIDATION

When SCL is high level, SDA level must be constant. SDA can be changed only when SCL is low level.

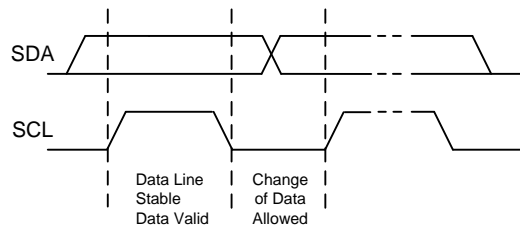
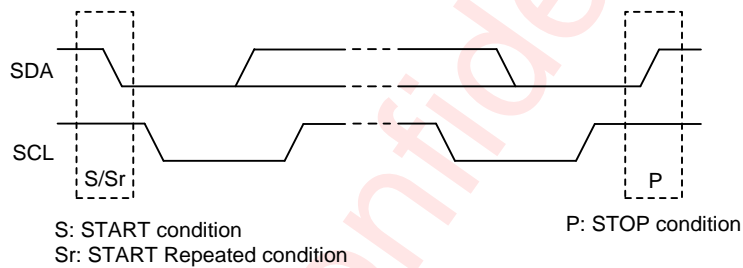

Figure 17 Data Validation Diagram

I²C START/STOP

I²C start: SDA changes from high level to low level when SCL is high level.

I²C stop: SDA changes from low level to high level when SCL is high level.

Figure 18 I²C Start/Stop Condition Timing**ACK (ACKNOWLEDGEMENT)**

ACK means the successful transfer of I²C bus data. After master sends 8bits data, SDA must be released; SDA is pulled to GND by slave device when slave acknowledges.

When master reads, slave device sends 8bit data, releases the SDA and waits for ACK from master. If ACK is send and I²C stop is not send by master, slave device sends the next data. If ACK is not send by master, slave device stops to send data and waits for I²C stop.

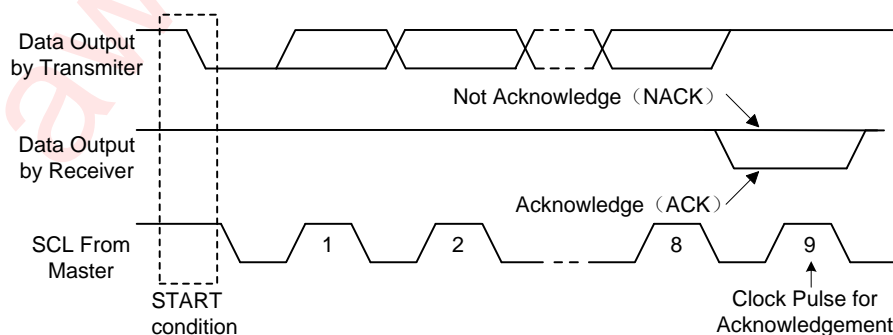
Figure 19 I²C ACK Timing

WRITE CYCLE

One data bit is transferred during each clock pulse. Data is sampled during the high state of the serial clock (SCL). Consequently, throughout the clock's high period, the data should remain stable. Any changes on the SDA line during the high state of the SCL and in the middle of a transaction, aborts the current transaction. New data should be sent during the low SCL state. This protocol allows a single data line to transfer both command/control information and data using the synchronous serial clock.

Each data transaction is composed of a Start Condition, a number of byte transfers (set by the software) and a Stop Condition to terminate the transaction. Every byte written to the SDA bus must be 8 bits long and is transferred with the most significant bit first. After each byte, an Acknowledge signal must follow.

In a write process, the following steps should be followed:

- a) Master device generates START condition. The "START" signal is generated by lowering the SDA signal while the SCL signal is high.
- b) Master device sends slave address (7-bit) and the data direction bit ($r/w = 0$).
- c) Slave device sends acknowledge signal if the slave address is correct.
- d) Master sends control register address (8-bit).
- e) Slave sends acknowledge signal.
- f) Master sends high data byte of 16-bit data to be written to the addressed register.
- g) Slave sends acknowledge signal.
- h) Master sends low data byte of 16-bit data to be written to the addressed register.
- i) Slave sends acknowledge signal.
- j) If master will send further 16-bit data bytes the control register address will be incremented by one after acknowledge signal of step g (repeat step f to g).
- k) Master generates STOP condition to indicate write cycle end.

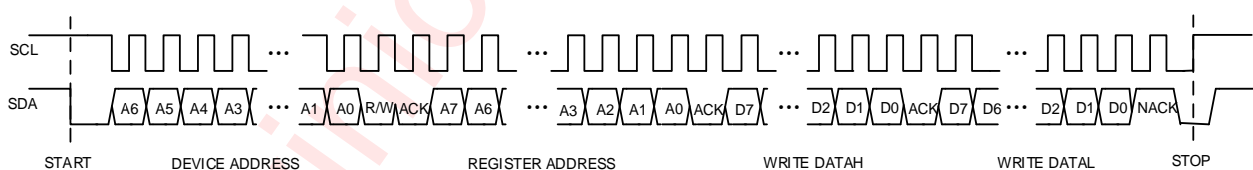

Figure 20 I²C Write Byte Cycle

READ CYCLE

In a read cycle, the following steps should be followed:

- a) Master device generates START condition.
- b) Master device sends slave address (7-bit) and the data direction bit ($r/w = 0$).
- c) Slave device sends acknowledge signal if the slave address is correct.

- d) Master sends control register address (8-bit).
- e) Slave sends acknowledge signal.
- f) Master generates STOP condition followed with START condition or REPEAT START condition.
- g) Master device sends slave address (7-bit) and the data direction bit ($r/w = 1$).
- h) Slave device sends acknowledge signal if the slave address is correct.
- i) Slave sends read high data byte of 16-bit data from addressed register.
- j) Master sends acknowledge signal.
- k) Slave sends read low data byte of 16-bit data from addressed register.
- l) If the master device sends acknowledge signal, the slave device will increase the control register address by one, then send the next 16-bit data from the new addressed register.
- m) If the master device generates STOP condition, the read cycle is ended.

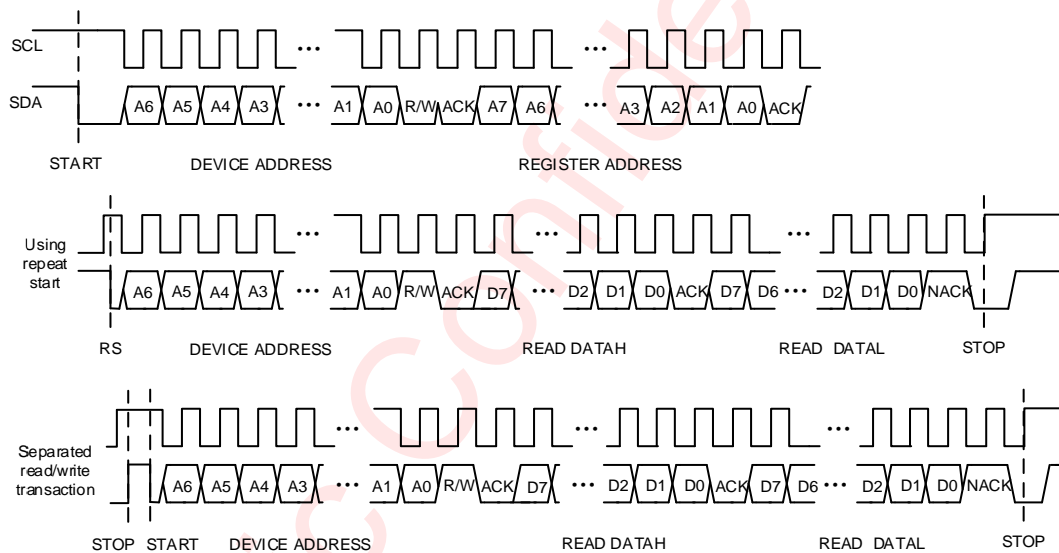

Figure 21 I²C Read Byte Cycle

REGISTER MAP

REGISTER DESCRIPTION

REGISTER LIST

ADDR	NAME	R/W	Bit15	Bit14	Bit13	Bit12	Bit11	Bit10	Bit9	Bit8	Bit7	Bit6	Bit5	Bit4	Bit3	Bit2	Bit1	Bit0				
0x00	ID	RO	IDCODE																			
0x01	SYSST	RO		UVLS	ADPS		BSTOCS	OVPS	BSTS	SWS			NOCLKS	CLKS	OCDS	UVLDS	OTHS	PLLS				
0x02	SYSINT	RC		UVLI	ADPI		BSTOCI	OVPI	BSTI	SWI			NOCLKI	CLKI	OCDI	UVLDI	OTHI	PLLI				
0x03	SYSINTM	RW		UVLM	ADPM		BSTOCM	OVPM	BSTM	SWM			NOCLKM	CLKM	OCDM	UVLDM	OTHM	PLLM				
0x04	SYSCTRL	RW	DRVSTRH				RMSE	HAGCE	HDCCE	HMUTE	EN_TRAN	I2SEN	WSINV	BCKINV	IPLL		AMPPD	PWDN				
0x05	SYSCTRL2	RW	IV2CH	I2SDOSEL	DOHZ	I2SCHS	INTMODE	INTN	VOL													
0x06	I2SCTRL1	RW	I2SRXEN	I2STXEN	CFSEL		CHSEL		I2SMD		I2SFS		I2SBCK		I2SSR							
0x07	I2SCTRL2	RW	FSTYPE	SLOT_NUM			I2S_TX_SLOTVLD				I2S_RXR_SLOTVLD				I2S_RXL_SLOTVLD							
0x08	DACCFG1	RW	RVTH								AVTH											
0x09	DACCFG2	RW	ATTH																			
0x0a	DACCFG3	RW	RTTH																			
0x0b	DACCFG4	RW											HOLDTH									
0x20	DACST	RO														BSTVOUT_ST						
0x21	VBAT	RO											VBAT_DET									
0x22	TEMP	RO											TEMP_DET									
0x23	PVDD	RO											PVDD_DET									
0x60	BSTCTRL1	RW					BST_RTH						BST_ATH									
0x61	BSTCTRL2	RW					BST_IPEAK				BST_TDEG				BST_MODE				VOUT_VREFSET			

REGISTER DEFAULT

ADDR	NAME	R/W	Reset Value
0x00	ID	RO	0x2013
0x01	SYSST	RO	0x0000
0x02	SYSINT	RC	0x0000
0x03	SYSINTM	RW	0xFFFF
0x04	SYSCTRL	RW	0xD303
0x05	SYSCTRL2	RW	0x6000
0x06	I2SCTRL1	RW	0x84E8
0x07	I2SCTRL2	RW	0x0010
0x08	DACCFG1	RW	0x3940
0x09	DACCFG2	RW	0x0030
0x0a	DACCFG3	RW	0x01E0
0x0b	DACCFG4	RW	0x1C64
0x20	HAGCST	RO	0x0500
0x21	VBAT	RO	0x0263
0x22	TEMP	RO	0x0019
0x23	PVDD	RO	0x0263
0x60	BSTCTRL1	RW	0x8402
0x61	BSTCTRL2	RW	0x6B3B

DETAILED REGISTER DESCRIPTION

ID: (Address 00h)				
Bit	Symbol	R/W	Description	Default
15:0	IDCODE	RO	Chip ID will be returned after read. All configuration registers will be reset to default value after 0x55aa is written	0x2013

SYSST: (Address 01h)				
Bit	Symbol	R/W	Description	Default
15	Reserved	RO	Not used	0
14	UVLS	RO	VBAT under UVLO threshold voltage indicator 0: Normal 1: UVLO	0
13	ADPS	RO	Boost Adaptive status indicator. 0: Transparent 1: Boost	0
12	Reserved	RO	Not used	0
11	BSTOCS	RO	Boost over current indicator 0: Normal 1: Over Current	0
10	OVPS	RO	Boost OVP status indicator 0: Normal 1: OVP	0
9	BSTS	RO	Boost start up finished indicator. 0: Not finished 1: Finished	0
8	SWS	RO	Amplifier switching status indicator. 0: Not switching 1: Switching	0
7:6	Reserved	RO	Not used	0
5	NOCLKS	RO	The reference clock of PLL status indicator 0: Clock Ok 1: No Clock	0
4	CLKS	RO	Internal clocks status flag 0: At least one clocks are unstable 1: Stable	0
3	OCDS	RO	Over current status in amplifier 0: Normal 1: OC	0
2	UVLDS	RO	DVDD under UVLO threshold voltage indicator 0: Normal 1: UVLO	0
1	OTHS	RO	OT indicator, Die Temperature is higher than 150 degrees or not 0: Normal 1: OT	0
0	PLLS	RO	PLL locked status indicator. 0: Unlocked 1: Locked	0

SYSINT: (Address 02h)				
Bit	Symbol	R/W	Description	Default
15	Reserved	RC	Not used	0
14	UVLI	RC	Interrupt indicator for VBAT Power On and UVLS	0
13	ADPI	RC	Interrupt indicator for ADPS	0
12	Reserved	RC	Not used	0
11	BSTOCI	RC	Interrupt indicator for BSTOCS.	0
10	OVPI	RC	Interrupt indicator for OVPS.	0
9	BSTI	RC	Interrupt indicator for BSTS.	0
8	SWI	RC	Interrupt indicator for SWS.	0
7:6	Reserved	RC	Not used	0
5	NOCLKI	RC	Interrupt indicator for NOCLKS.	0
4	CLKI	RC	Interrupt indicator for CLKS.	0
3	OCDI	RC	Interrupt indicator for OCDS	0
2	UVLDI	RC	Interrupt indicator for UVLDS	0
1	OTHI	RC	Interrupt indicator for OTHS.	0
0	PLLI	RC	Interrupt indicator for PLLS.	0

Note: It will be set to '1' once corresponding status bit changed, and all the interrupt bits will be cleared after reading 0x02 via IIC bus.

SYSINTM: (Address 03h)				
Bit	Symbol	R/W	Description	Default
15	Reserved	RW	Not used	1
14	UVLM	RW	Interrupt mask for UVLI.	1
13	ADPM	RW	Interrupt mask for ADPI	1
12	Reserved	RW	Not used	1
11	BSTOCM	RW	Interrupt mask for BSTOCI.	1
10	OVPM	RW	Interrupt mask for OVPI	1
9	BSTM	RW	Interrupt mask for BSTI.	1
8	SWM	RW	Interrupt indicator for SWI.	1
7:6	Reserved	RW	Not used	1
5	NOCLKM	RW	Interrupt mask for NOCLKI.	1
4	CLKM	RW	Interrupt mask for CLKI.	1
3	OCDM	RW	Interrupt mask for OCDI.	1
2	UVLDM	RW	Interrupt mask for UVLDI.	1
1	OTHM	RW	Interrupt mask for OTHI.	1
0	PLLM	RW	Interrupt mask for PLLI.	1

Note: All the mask bits are high-active. The interrupt will be masked when its corresponding mask bit is set to "1", then this interrupt will not be sent to INTN pin.

SYSCTRL: (Address 04h)				
Bit	Symbol	R/W	Description	Default
15	DRVSTRH	RW	I2S_DATAO PAD driving strength setting 0: 4mA 1: 12mA	1
14:12	Reserved	RW	Not used	0x3
11	RMSE	RW	Hardware HAGC mode selection 0: Peak AGC 1: RMS AGC	0
10	HAGCE	RW	Disable/Enable Hardware AGC 0: Disable 1: Enable	0
9	HDCCE	RW	Disable/Enable Hardware DC Canceling module 0: Disable 1: Enable	1
8	HMUTE	RW	Disable/Enable Hardware mute module 0: Disable 1: Enable	1
7	EN_TRAN	RW	Transparent mode control for Class D 0: SPK 1: RCV	0
6	I2SEN	RW	Disable/Enable whole I ² S interface module 0: Disable 1: Enable	0
5	WSINV	RW	I ² S Left/Right channel switch control 0: Not switch 1: Switch	0
4	BCKINV	RW	I ² S bit clock invert control 0: Not invert 1: Inverted	0
3	IPLL	RW	PLL reference clock selection 0: BCK 1: WCK	0
2	Reserved	RW	Not used	0
1	AMPPD	RW	Amplifier power down control bit, Power Down until system configuration is finished 0: Working 1: Power Down	1
0	PWDN	RW	System power down control bit 0: Working 1: Power Down	1

SYSCTRL2: (Address 05h)				
Bit	Symbol	R/W	Description	Default
15	IV2CH	RW	I ² S TX channel data packing mode control. When I2SBCK is set to 32*fs mode, TX data could be transmitted to I ² S Left & Right channels by using Special Mode. 0: Legacy 1: Special	0
14	I2SDOSEL	RW	I ² S unused channels output data selection 0: Zeros 1: TX Data	1

13	DOHZ	RW	Unused channel Data control, When it is set to 0, all Channels are available, otherwise unused channels are set to be HiZ. 0: All 1: HiZ	1
12	I2SCHS	RW	I ² S TX Channel selection for I ² S mode 0: Left 1: Right	0
11	INTMODE	RW	Interrupt pad INTN output mode selection 0: Open-drain 1: Push-Pull	0
10	INTN	RW	Interrupt pad INTN pin-source selection 0: SYSINT 1: SYSST	0
9:0	VOL	RW	Volume control, from 0 to -95.875dB Vol[5:0] = mod(Volume,-6) / 0.125, in unit of -0.125dB Vol[9:6] = floor(Volume/-6), in unit of -6dB	0

I2SCTRL1: (Address 06h)				
Bit	Symbol	R/W	Description	Default
15	I2SRXEN	RW	Disable/Enable I ² S receiver module 0: Disable 1: Enable	1
14	I2STXEN	RW	Disable/Enable I ² S transmitter module 0: Disable 1: Enable	0
13:12	CFSEL	RW	I ² S output data selection for DATAO 00: HAGC 01: I&V sense data 10: I&V&Vbat&Temp data Others: Reserved	0
11:10	CHSEL	RW	Left/right channel selection for I ² S input 00: Reserved 01: Left 10: Right 11: Mono	1
9:8	I2SMD	RW	I ² S data format mode selection 00: Philip Standard 01: MSB justified 10: LSB justified 11: Reserved	0
7:6	I2SFS	RW	I ² S data resolution selection 00: 16 bits 01: 20 bits 10: 24 bits 11: 32 bits	0x3
5:4	I2SBCK	RW	I ² S BCK mode 00: 32*fs 01: 48*fs 10: 64*fs 11: Reserved	0x2
3:0	I2SSR	RW	I ² S interface sample rate configuration 0000: 8kHz 0001: 11kHz	0x8

			0010: 12kHz 0011: 16kHz 0100: 22kHz 0101: 24kHz 0110: 32kHz 0111: 44kHz 1000: 48kHz 1001: 96kHz Others: Reserved	
--	--	--	--	--

I2SCTRL2: (Address 07h)				
Bit	Symbol	R/W	Description	Default
15	FSTYPE	RW	Audio Frame synchronization signal (WCK) pulse width configuration 0: One-slot 1: One-bck	0
14:12	SLOT_NUM	RW	I ² S interface mode control (support max to 8 slots). 000: I ² S mode 001: TDM1s 010: TDM2s 011: TDM4s 100: TDM6s 101: TDM8s Others: Reserved	0
11:8	I2S_TX_SLO TVLD	RW	TX slot selection, data will be sent to one of the 8 slots. 0000: Slot 0 0001: Slot 1 0010: Slot 2 0011: Slot 3 0100: Slot 4 0101: Slot 5 0110: Slot 6 0111: Slot 7 Others: Reserved	0
7:4	I2S_RXR_SL OTVLD	RW	RX right channel slot selection 0000: Slot 0 0001: Slot 1 0010: Slot 2 0011: Slot 3 0100: Slot 4 0101: Slot 5 0110: Slot 6 0111: Slot 7 Others: Reserved	1
3:0	I2S_RXL_SL OTVLD	RW	RX left channel slot selection 0000: Slot 0 0001: Slot 1 0010: Slot 2 0011: Slot 3 0100: Slot 4 0101: Slot 5 0110: Slot 6 0111: Slot 7 Others: Reserved	0

DACCFG1: (Address 08h)				
Bit	Symbol	R/W	Description	Default
15:8	RVTH	RW	Release Amplitude threshold, which is 90% of the AVTH register value $RVTH = \text{round}(AVTH * 0.9)$	0x39
7:0	AVTH	RW	Attack Amplitude threshold, in percent of signal full scale RMSE = 0 (Peak AGC) : $P0 = ((i/256 * \text{Gain})^{**2}) / R_{Load} / 2$ RMSE = 1 (RMS AGC) : $P0 = (i/256) * (\text{Gain}^{**2}) / R_{Load}$ i is the register value Gain is the Amplifier Gain, default 6.7 R_{Load} is $8\Omega/6\Omega/4\Omega$ for different application, default 8Ω	0x40

DACCFG2: (Address 09h)				
Bit	Symbol	R/W	Description	Default
15:0	ATTH	RW	HAGC Attack time threshold, in unit of $20.8\mu s$ 0: Reserved n: $n * 20.8\mu s$	0x0030

DACCFG3: (Address 0ah)				
Bit	Symbol	R/W	Description	Default
15:0	RTTH	RW	HAGC Release time threshold, in unit of $20.8\mu s$ 0: Reserved n: $n * 20.8\mu s$	0x01E0

DACCFG4: (Address 0bh)				
Bit	Symbol	R/W	Description	Default
15:8	Reserved	RW	Not used	0
7:0	HOLDTH	RW	HAGC Hold time before release, in unit of $1.33ms$ 0: Reserved n: $n * 1.33ms$	0x64

DACST: (Address 20h)				
Bit	Symbol	R/W	Description	Default
15:4	Reserved	RO	Not used	0
3:0	BSTVOUT_ST	RO	Actual setting of boost output voltage ($250mV/Step$) 0000: 3.25V 0001: 3.50V 0010: 3.75V ... 1011: 6.00V Others: Reserved	0

VBAT: (Address 21h)				
Bit	Symbol	R/W	Description	Default
15:10	Reserved	RO	Not used	0
9:0	VBAT_DET	RO	Detected Voltage of battery, and the full scale is $6.025V$ $VBAT = (VBAT_DET) / 1023 * 6.025$	0x263

TEMP: (Address 22h)				
Bit	Symbol	R/W	Description	Default
15:10	Reserved	RO	Not used	0
9:0	TEMP_DET	RO	Detected Die Temperature (Two's Complement), typical values are as	0x019

			follows. 0x3D8 : -40°C 0x000 : 0°C 0x019 : 25°C	
--	--	--	--	--

PVDD: (Address 23h)				
Bit	Symbol	R/W	Description	Default
15:10	Reserved	RO	Not used	0
9:0	PVDD_DET	RO	Detected Voltage of PVDD, and the full scale is 7.25V PVDD=(PVDD_DET)/1023 * 7.25	0x263

BSTCTRL1: (Address 60h)				
Bit	Symbol	R/W	Description	Default
15:14	Reserved	RW	Not used	0
13:8	BST_RTH	RW	Smart boost small signal release threshold setting, When the input signal is above the threshold, the voltage of PVDD will be raised up higher than VBAT in smart boost mode Release threshold = BST_RTH * 1/64 FullScale	0x4
7:6	Reserved	RW	Not used	0
5:0	BST_ATH	RW	Smart boost small signal attack threshold setting. When the input signal is below the threshold, the voltage of PVDD will be equal to VBAT in smart boost mode Attack threshold = BST_ATH * 1/64 FullScale	0x2

BSTCTRL2: (Address 61h)				
Bit	Symbol	R/W	Description	Default
15	Reserved	RW	Not used	0
14:12	BST_IPEAK	RW	Boost peak current limiter threshold 000: 1.20A 001: 1.40A 010: 1.60A 011: 1.80A 100: 2.00A 101: 2.25A 110: 2.50A 111: 2.75A	0x6
11:8	BST_TDEG	RW	Smart Boost small signal level detection deglitch time 0000: 0.50ms 0001: 1.00ms 0010: 2.00ms 0011: 4.00ms 0100: 8.00ms 0101: 10.7ms 0110: 13.3ms 0111: 16.0ms 1000: 18.6ms 1001: 21.3ms 1010: 24.0ms 1011: 32.0ms 1100: 64.0ms	0xB

			1101: 128ms 1110: 256ms 1111: 1200ms	
7:6	Reserved	RW	Not used	0
5:4	BST_MODE	RW	BOOST mode selection. 00: Transparent 01: Force Boost 10: Smart Boost 1 11: Smart Boost 2	0x3
3:0	VOUT_VREF SET	RW	BOOST max output voltage control bits (250mV/Step) 0000: 3.25V 0001: 3.50V 0010: 3.75V 0011: 4.00V 0100: 4.25V 0101: 4.50V 0110: 4.75V 0111: 5.00V 1000: 5.25V 1001: 5.50V 1010: 5.75V 1011: 6.00V Others: Reserved	0xB

APPLICATION INFORMATION

EXTERNAL COMPONENTS

BOOST INDUCTOR SELECTION

Inductance value is limited by the boost converter's internal loop compensation, a large L_{SW} will reduce the phase margin of the DC-to-DC converter. Also, the inductor should have low core loss at 1MHz (Min.) and low DCR for better efficiency under all operating conditions, the recommended value of inductor is 1 μ H.

Inductor saturation current and temperature rise current value are important basis for selecting the inductor. As the inductor current increases, inductance value will decline since the magnetic core begins to saturate; on the other hand, the inductor's parasitic resistance inductance and magnetic core loss can lead to temperature rise. The inductor saturation current rating could to be considered with the following equation:

$$I_{L_PEAK} = \frac{2 * P_{Out}}{\eta * V_{BAT}} + \frac{V_{BAT} * (V_{PVDD} - V_{BAT})}{2 * L_{SW} * F_{BST} * V_{PVDD}}$$

Following is the inductor selection reference for typical speaker impedances.

V _{BAT} (V)	PVDD (V)	R _L (Ω)	I _{PEAK} (A)	Total Eff. η (%)	P _{Out} (W)	I _{L_PEAK} (A)	I _{SAT_min} (A)
4.2	6.0	8	2.5	85	2.0	1.51	2.75
4.2	6.0	6	2.5	85	2.5	1.79	2.75
4.2	5.5	4	2.5	81	3.0	2.07	2.75

Note: The maximum Boost output voltage V_{PVDD} should be 5.5V when the load resistance R_L is less than 5 Ω .

BOOST CAPACITOR SELECTION

Boost output capacitor is usually within the range 0.1 μ F~47 μ F. The ceramic capacitors with low ESR are recommended for low ripple voltage which is determined as following equation:

$$\Delta V_{PVDD} = \frac{(V_{PVDD} - V_{BAT}) * I_{OUT}}{\eta * V_{PVDD} * F_{BST} * C_{OUT}} + \left(\frac{I_{OUT} * V_{PVDD}}{V_{BAT}} + \frac{V_{BAT} * (V_{PVDD} - V_{BAT})}{2 * L_{SW} * F_{BST} * V_{PVDD}} \right) * R_{C_ESR}$$

Capacitor is selected based on the requirements of temperature stability and voltage stability, considering the material, size, capacitor voltage, and capacitance values. It is suggested to use Class II type (EIA) multilayer ceramic capacitors (MLCC). Its internal dielectric is ferroelectric material (typically BaTiO₃), a high the dielectric constant in order to achieve smaller size, but at the same Class II type (EIA) multilayer ceramic capacitors has poor temperature stability and voltage stability as compared to the Class I type (EIA) capacitance.

Please notice the DC bias characteristics when selecting capacitors. For typical applications, it is necessary to ensure that the residual capacitance is higher than 3 μ F. Take the following capacitances as the output capacitor of boost for example:

Value	Material	Size (mm ³)	Rated Voltage	Quantity	Value@6.0V
10 μ F	X5R	1.00x0.50x0.50 (0402)	10V	2	3.2 μ F

Value	Material	Size (mm ³)	Rated Voltage	Quantity	Value@6.0V
10 μ F	X5R	2.00x0.80x0.85 (0805)	16V	1	3.5 μ F

SUPPLY DECOUPLING CAPACITOR

The device is a high-performance audio amplifier that requires adequate power supply decoupling. A 0.1 μ F low equivalent-series-resistance (ESR) ceramic capacitor are recommended. This choice of capacitor and placement helps with higher frequency transients, spikes, or digital hash on the line. Additionally, placing this decoupling capacitor close to the DEVICE is important, as any parasitic resistance or inductance between the device and the capacitor causes efficiency loss. In addition to the 0.1 μ F ceramic capacitor, place a 10 μ F capacitor on the VBAT supply trace. This larger capacitor acts as a charge reservoir, providing energy faster than the board supply, thus helping to prevent any droop in the supply voltage.

FILTER FREE OPERATION AND FERRITE BEAD FILTERS

If the PA is close to the EMI sensitive circuits and/or there are long leads from amplifier to speaker, a ferrite bead filter could be used, and placed as close as possible to the output pins of the PA. When choosing a ferrite bead, select a ferrite bead with adequate current rating to prevent distortion of the output signal. In addition, a 0.1nF ceramic capacitor is typically recommended, and its rated voltage should be above 10V.

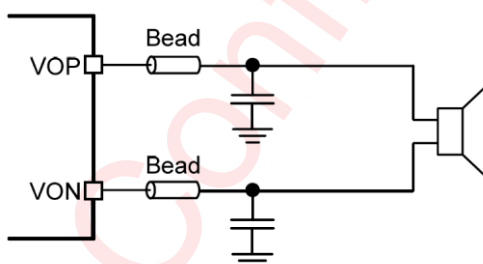

LAYOUT CONSIDERATION

In order to obtain excellent performance of the PA, the below PCB layout guidelines should be followed:

1. All the filter capacitors should be placed close to the corresponding pins of the PA, including VBST, VBAT, DVDD, and VDDIO.
2. The traces of SW pin should support currents up to the device over-current limit (peak current 2.75A), and the input line from the battery to the VBAT pin should be traced above 500mA current drive.
3. For the case of speaker impedance equal to 8 Ω , try to provide a separate, short and thick power line to the PA, the copper width is recommended to be larger than 0.75mm.
4. The beads and capacitor should be placed close to the VON and VOP pin. The output line from PA to speaker should be as short and thick as possible. The width is recommended to be larger than 0.5mm.
5. The via numbers determine the current capability. Typically, the boost converter trace need four via to handle the current requirement around 2A.
6. The capacitance on the output lines or on the long speaker tracks should be less than 1nF.

PACKAGE DESCRIPTION

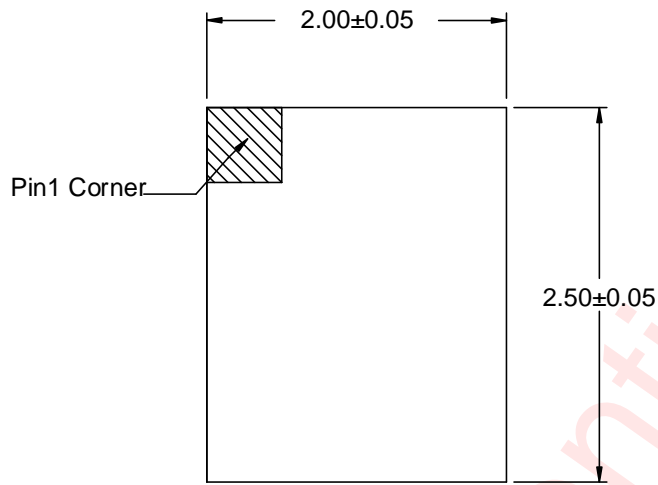

Top View



Side View

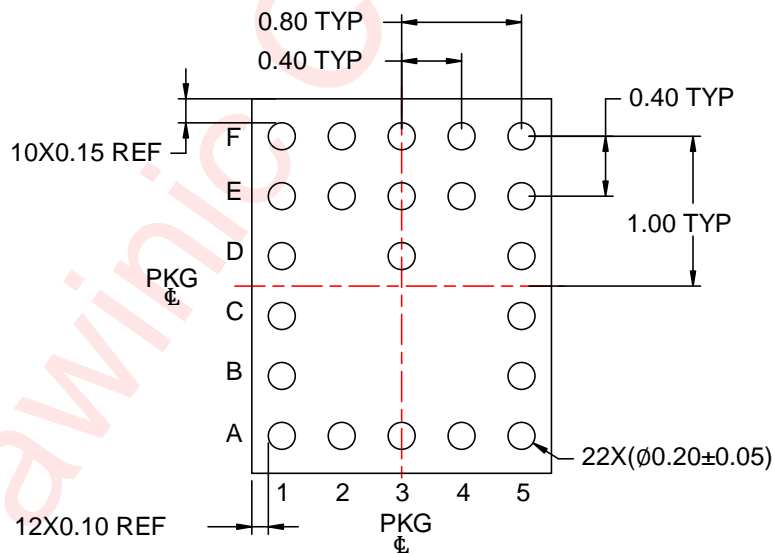

Bottom View

Unit:mm

LAND PATTERN DATA

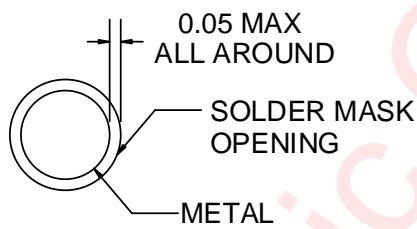
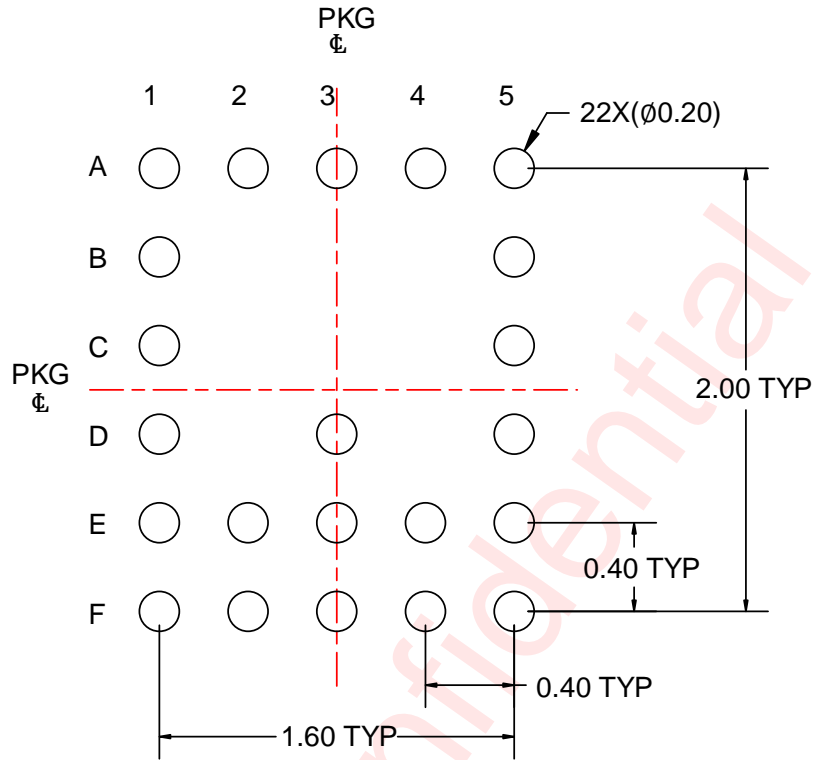

NON SOLDER MASK DEFINED

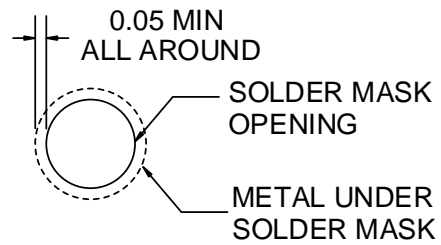

SOLDER MASK DEFINED

Unit: mm

TAPE AND REEL INFORMATION

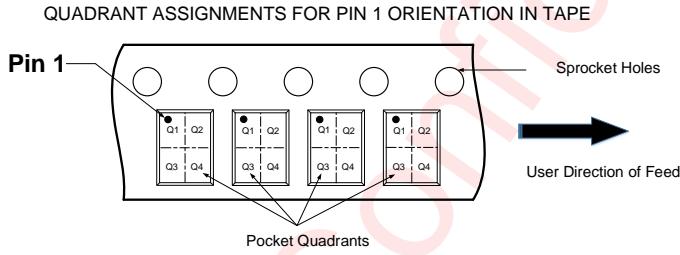
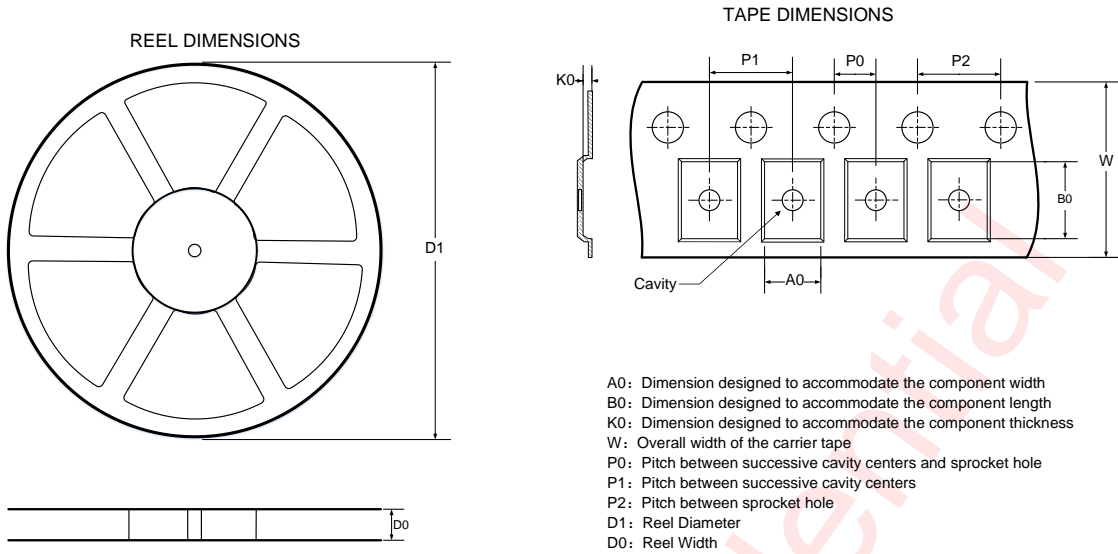

DIMENSIONS AND PIN1 ORIENTATION

D1 (mm)	D0 (mm)	A0 (mm)	B0 (mm)	K0 (mm)	P0 (mm)	P1 (mm)	P2 (mm)	W (mm)	Pin1 Quadrant
330	12.40	2.20	2.67	0.83	2	8	4	12	Q1

All dimensions are nominal

REVISION HISTORY

Version	Date	Change Record
V1.0	Oct. 2020	Officially Released
V1.1	Apr. 2021	Update Tape and Reel Information
V1.2	Jul. 2021	Update characteristics table of VDDIO Update for 4Ω application
V1.3	May. 2023	Add 4Ω application description

awinic Confidential

DISCLAIMER

Information in this document is believed to be accurate and reliable. However, Shanghai AWINIC Technology Co., Ltd (AWINIC Technology) does not give any representations or warranties, expressed or implied, as to the accuracy or completeness of such information and shall have no liability for the consequences of use of such information.

AWINIC Technology reserves the right to make changes to information published in this document, including without limitation specifications and product descriptions, at any time and without notice. Customers shall obtain the latest relevant information before placing orders and shall verify that such information is current and complete. This document supersedes and replaces all information supplied prior to the publication hereof.

AWINIC Technology products are not designed, authorized or warranted to be suitable for use in medical, military, aircraft, space or life support equipment, nor in applications where failure or malfunction of an AWINIC Technology product can reasonably be expected to result in personal injury, death or severe property or environmental damage. AWINIC Technology accepts no liability for inclusion and/or use of AWINIC Technology products in such equipment or applications and therefore such inclusion and/or use is at the customer's own risk.

Applications that are described herein for any of these products are for illustrative purposes only. AWINIC Technology makes no representation or warranty that such applications will be suitable for the specified use without further testing or modification.

All products are sold subject to the general terms and conditions of commercial sale supplied at the time of order acknowledgement.

Nothing in this document may be interpreted or construed as an offer to sell products that is open for acceptance or the grant, conveyance or implication of any license under any copyrights, patents or other industrial or intellectual property rights.

Reproduction of AWINIC information in AWINIC data books or data sheets is permissible only if reproduction is without alteration and is accompanied by all associated warranties, conditions, limitations, and notices. AWINIC is not responsible or liable for such altered documentation. Information of third parties may be subject to additional restrictions.

Resale of AWINIC components or services with statements different from or beyond the parameters stated by AWINIC for that component or service voids all express and any implied warranties for the associated AWINIC component or service and is an unfair and deceptive business practice. AWINIC is not responsible or liable for any such statements.