

Slotted Switch OPB885Z

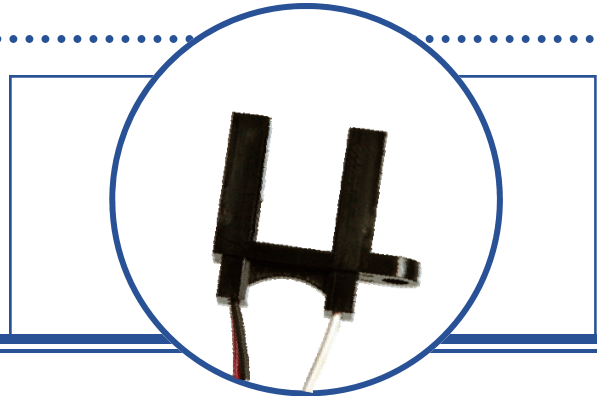

Features:

- 24" (610 mm) long 26 gauge wired assembly
- Non-contact infrared switch
- Opaque plastic housing
- 0.375" (9.5 mm) slot width
- 0.595" (15.1 mm) slot depth



Description:

OPB885 uses an Infrared LED and a phototransistor in a slotted switch configuration. The assembly has 24" (610mm) 26 AWG wires on each terminal and uses an opaque housing to reduce the sensor's ambient light sensitivity. Each discrete has an 0.050" (1.27 mm) aperture that focuses the switching sensitivity and limits ambient light absorption by the phototransistor. The housing is made from an opaque plastic with IR transmissive plastic in the front of each aperture to provide dust protection.

In the normal unobstructed slot, infrared light from the LED, radiates the phototransistor and becomes forward biased and is considered to be in the "on" state, providing an $I_{C(ON)}$ current that is proportional to the light striking the phototransistor. As the light is blocked by using an opaque object that blocks the infrared light from the LED to the phototransistor, the phototransistor turns "off," minimizing the $I_{C(ON)}$ current and thus allowing the electrical state to be considered switched.

Custom electrical, wire and cabling and connectors are available. Contact your local representative or OPTEK for more information.

Applications:

- Non-contact interruptive object sensor
- Assembly line automation
- Machine automation
- Equipment security
- Machine safety
- End of travel sensor
- Door sensor

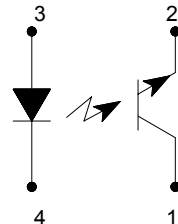

Ordering Information	
Part Number	Description
OPB885	Non-contact infrared switch

Pin #	Description
White-1	Collector
Green-2	Emitter
Red-3	Anode
Black-4	Cathode



RoHS

OPTEK reserves the right to make changes at any time in order to improve design and to supply the best product possible.

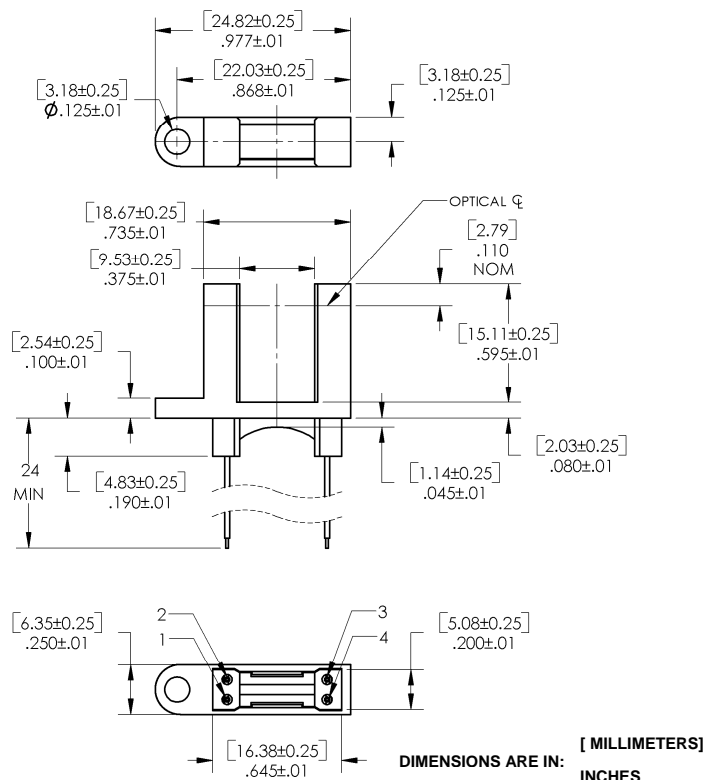

Absolute Maximum Ratings ($T_A=25^{\circ}\text{C}$ unless otherwise noted)

Storage Temperature	-40° C to +100° C
Operating Temperature	-40° C to +85° C
Lead Soldering Temperature (1/16 inch (1.6mm) from the case for 5 sec. with soldering iron) ⁽²⁾	260° C

LED

Forward Current	50 mA
Peak Forward Current (2 μs pulse width, 0.1% duty cycle)	1 A
Reverse DC Voltage	3 V
Power Dissipation	100 mW

Output Phototransistor

Collector-Emitter Voltage	30 V
Collector DC Current	50 mA
Power Dissipation	100 mW

Electrical Characteristics ($T_A = 25^{\circ}\text{C}$ unless otherwise noted)

SYMBOL	PARAMETER	MIN	TYP	MAX	UNITS	TEST CONDITIONS
--------	-----------	-----	-----	-----	-------	-----------------

Input Diode (see OP345 for additional information)

V_F	Forward Voltage	-	-	1.7	V	$I_F = 20 \text{ mA}$
I_R	Reverse Current	-	-	100	μA	$V_R = 3 \text{ V}$

Output Phototransistor (see OP555 for additional information)

BV_{CEO}	Collector-Emitter Breakdown Voltage	30	-	-	V	$I_C = 1 \text{ mA}$
I_{CEO}	Collector-Emitter Dark Current	-	-	100	nA	$V_{CE} = 10 \text{ V}$

Combined

$V_{CE(SAT)}$	Collector-Emitter Saturation Voltage	-	-	0.6	V	$I_C = 1 \text{ mA}, I_F = 20 \text{ mA}$
$I_{C(ON)}$	On-State Collector Current	1.3	-	8	mA	$V_{CE} = 5 \text{ V}, I_F = 20 \text{ mA}$

Notes:

- (1) All parameters tested using pulse technique.
- (2) RMA flux is recommended. Duration can be extended to 10 seconds maximum when flow soldering.
- (3) Methanol or isopropanol are recommended as cleaning agents. The plastic housing is soluble in chlorinated hydrocarbons and keytones.

OPTEK reserves the right to make changes at any time in order to improve design and to supply the best product possible.

OPB885 - Flag Next to Emitter

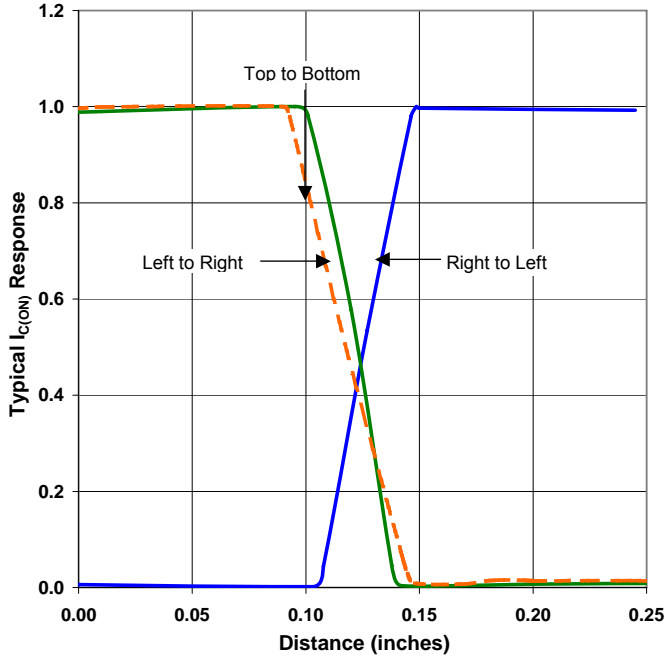

OPB885 - Flag Next to Sensor

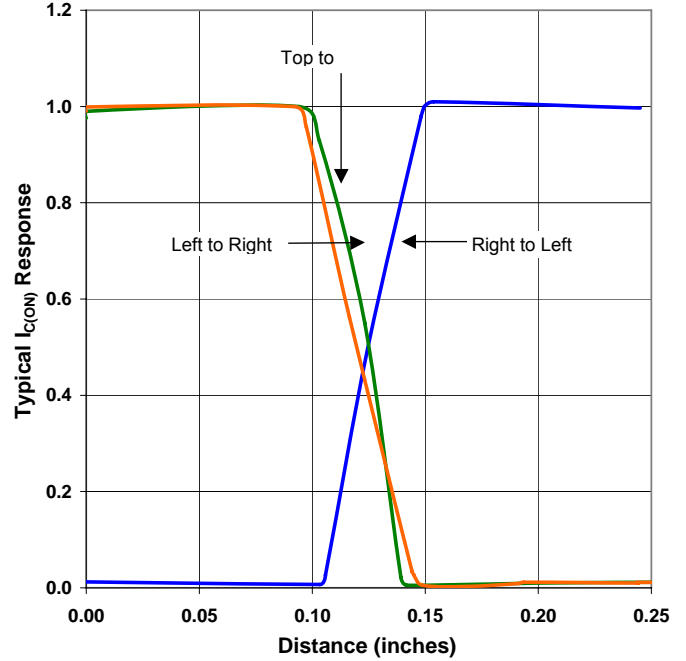

OPB885 - Flag in Middle of Slot

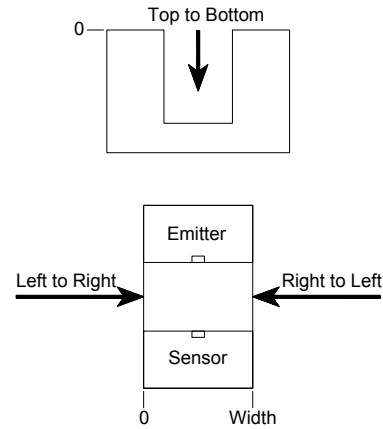
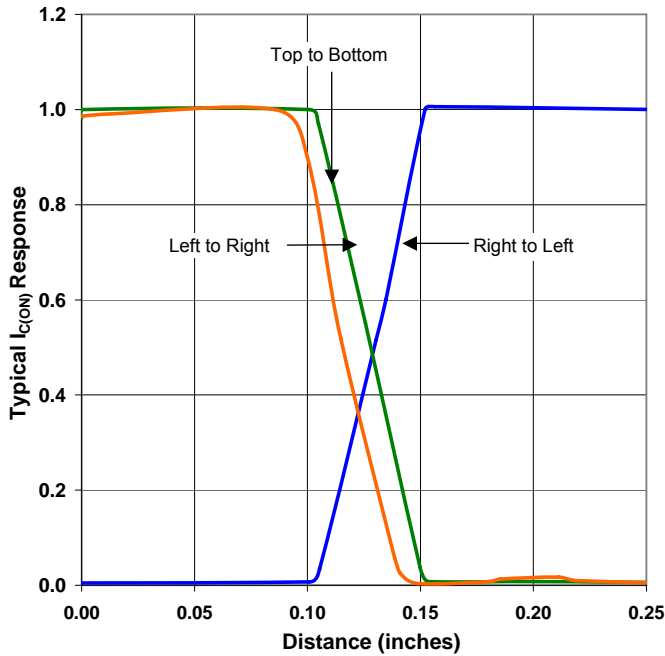

OPTEK reserves the right to make changes at any time in order to improve design and to supply the best product possible.