

# USB 2.0 TYPE A IP67 PANEL MOUNTED RECEPTACLE

Inline coupling – Bayonet locking – Square flange – Zinc die-cast

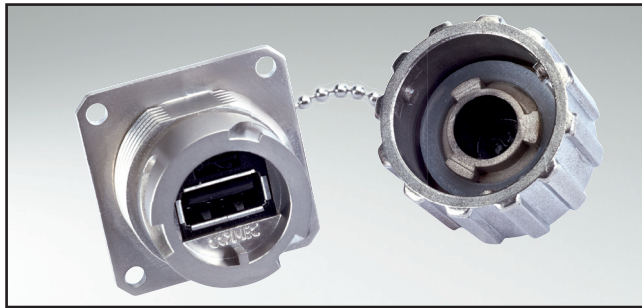

UL listed, File No.: E202784

### DESCRIPTION

- For front- and rear panel mounting up to wall thickness of 3.2 mm
- Design: Zinc die-cast nickel plated
- Termination inside USB 2.0 Type A
- Bayonet locking per IEC 61076-3-106
- IP67-Protection in mated condition
- Available as set with protection cap
- Accessories:  
Gasket and mounting hardware can be ordered separately
- Mounting hardware includes  
4x (screw M3 + nut + flat washer + spring washer)

### PRODUCT DRAWING

Recommended Panel Cutout

Double-D Panel Cut-out

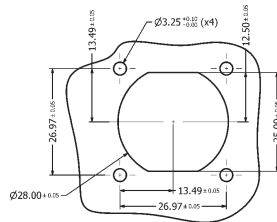

Round Panel Cut-out

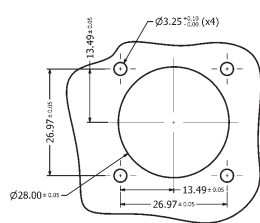

without assembly

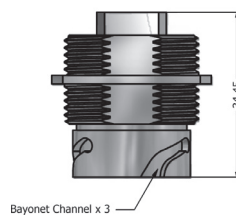

with assembly

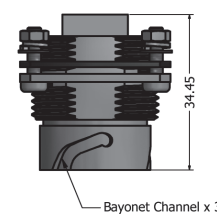

Protection cap metal

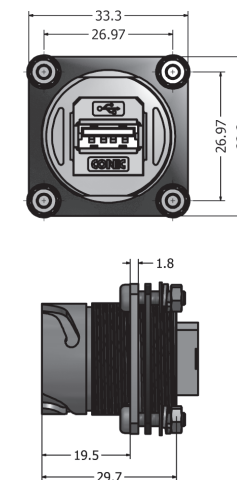
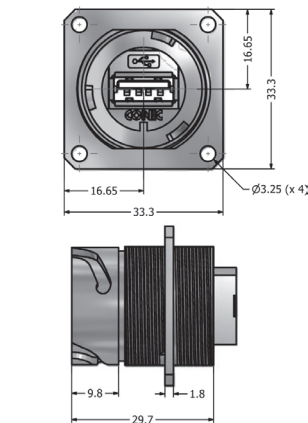
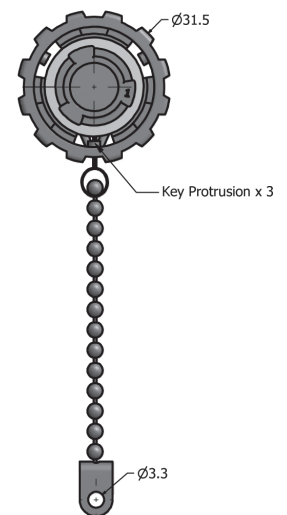

### ORDER DATA

Type	Material	Surface	Protection cap	Part Number
Receptacle without assembly	Zinc die-cast	nickel plated	without Protection cap	17-200781
Panel gasket	Silicone			17-103540
Mounting hardware	Stainless steel			17-103530
Receptacle with assembly	Zinc die-cast	nickel plated	without Protection cap	17-210111
Receptacle with assembly	Zinc die-cast	nickel plated	with Protection cap	17-210121