

IMB12-08NDSVU2K

IMB

INDUCTIVE PROXIMITY SENSORS

SICK
Sensor Intelligence.



Illustration may differ

Ordering information

Type	Part no.
IMB12-08NDSVU2K	1076281

Included in delivery: BEF-MU-M12N (2)

Other models and accessories → www.sick.com/IMB



Detailed technical data

Features

Housing	Cylindrical thread design
Housing	Short-body
Thread size	M12 x 1
Diameter	Ø 12 mm
Sensing range S_n	8 mm
Safe sensing range S_a	6.48 mm
Installation type	Non-flush
Switching frequency	2,000 Hz
Connection type	Cable, 2-wire, 2 m
Output function	NO
Electrical wiring	DC 2-wire
Enclosure rating	IP68 ¹⁾ IP69K ²⁾
Special features	Resistant against coolant lubricants, Visual adjustment indicator

¹⁾ According to EN 60529.

²⁾ According to ISO 20653:2013-03.

Mechanics/electronics

Supply voltage	10 V DC ... 30 V DC
Ripple	≤ 10 %
Voltage drop	≤ 4 V ¹⁾ ≤ 4.5 V ²⁾
Time delay before availability	≤ 100 ms
Hysteresis	3 % ... 20 %
Reproducibility	≤ 2 % ³⁾ ⁴⁾

¹⁾ At I_a = 30 mA.

²⁾ At I_a max.

³⁾ U_b and T_a constant.

⁴⁾ Of S_r.

⁵⁾ Valid if toothed side of nut is used.

⁶⁾ Reference voltage DC 50 V.

Temperature drift (of S_r)	± 10 %
EMC	According to EN 60947-5-2
Continuous current I_a	≤ 100 mA
Off-state current	Typ. 0.8 mA (≤ 1.2 mA at U _b max and 100 ° C)
Minimum load current	≥ 3 mA
Cable material	PUR
Short-circuit protection	✓
Reverse polarity protection	✓
Power-up pulse	≤ 5 ms
Shock and vibration resistance	100 g / 2 ms / 500 cycles; 150 g / 1 Mio cycles; 10 Hz ... 55 Hz / 1 mm; 55 Hz ... 500 Hz / 60 g
Ambient operating temperature	-40 °C ... +100 °C
Housing material	Stainless steel, V2A (1.4305)
Sensing face material	Plastic, LCP
Housing length	34 mm
Thread length	25 mm
Tightening torque, max.	Typ. 32 Nm ⁵⁾
Items supplied	Mounting nut, V2A stainless steel, with locking teeth (2x)
Protection class	II ⁶⁾
UL File No.	E181493

1) At I_a = 30 mA.

2) At I_a max.

3) U_b and T_a constant.

4) Of S_r.

5) Valid if toothed side of nut is used.

6) Reference voltage DC 50 V.

Safety-related parameters

MTTF_D	1,287 years
DC_{avg}	0%

Reduction factors

Note	The values are reference values which may vary
Stainless steel (V2A, 304)	Approx. 0.67
Aluminum (Al)	Approx. 0.42
Copper (Cu)	Approx. 0.35
Brass (Br)	Approx. 0.42

Installation note

Remark	Associated graphic see "Installation"
A	12 mm
B	24 mm
C	12 mm
D	24 mm
E	16 mm

F	64 mm
----------	-------

Classifications

ECl@ss 5.0	27270101
ECl@ss 5.1.4	27270101
ECl@ss 6.0	27270101
ECl@ss 6.2	27270101
ECl@ss 7.0	27270101
ECl@ss 8.0	27270101
ECl@ss 8.1	27270101
ECl@ss 9.0	27270101
ETIM 5.0	EC002714
ETIM 6.0	EC002714
UNSPSC 16.0901	39122230

Installation note

Non-flush installation

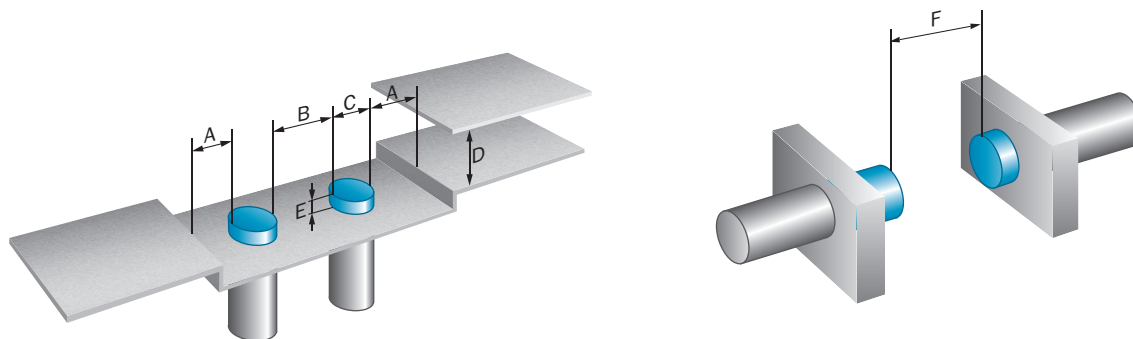

Connection diagram

Cd-012

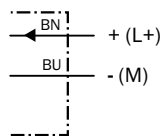

Characteristic curve

Response diagram

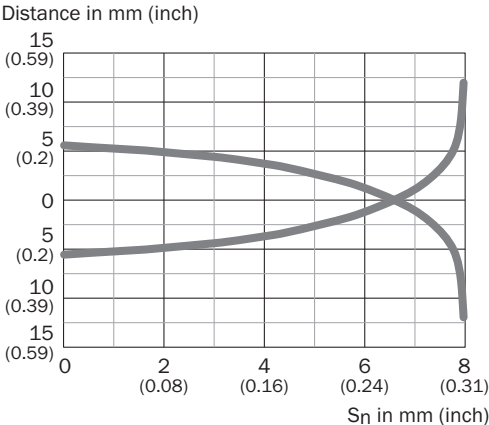

Adjustments possible

Installation aid

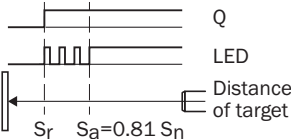





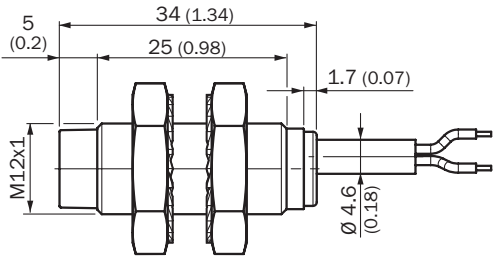

Dimensional drawing (Dimensions in mm (inch))

IMB12 Short-body housing, cable, non-flush



Recommended accessories

Other models and accessories → www.sick.com/IMB

	Brief description	Type	Part no.
Universal bar clamp systems			
	Plate N05N for universal clamp bracket, M12, Stainless steel 1.4571 (sheet), Stainless steel 1.4408 (clamp), Universal clamp (5322626), mounting hardware	BEF-KHS-N05N	2051621
Mounting brackets and plates			
	Mounting plate for M12 sensors, stainless steel, without mounting hardware	BEF-WG-M12N	5320950
	Mounting bracket for M12 housing, stainless steel, without mounting hardware	BEF-WN-M12N	5320949
Plug connectors and cables			
	Head A: female connector, M12, 4-pin, straight Head B: - Cable: unshielded	DOS-1204-GN	6028357
	Head A: female connector, M12, 4-pin, angled Head B: - Cable: unshielded	DOS-1204-WN	6028358
	Head A: male connector, M12, 4-pin, straight Head B: - Cable: unshielded	STE-1204-GN	6028359
	Head A: male connector, M12, 4-pin, straight Head B: - Cable: unshielded For 2 cable connections	STE-1204-TN	6028360

SICK AT A GLANCE

SICK is one of the leading manufacturers of intelligent sensors and sensor solutions for industrial applications. A unique range of products and services creates the perfect basis for controlling processes securely and efficiently, protecting individuals from accidents and preventing damage to the environment.

We have extensive experience in a wide range of industries and understand their processes and requirements. With intelligent sensors, we can deliver exactly what our customers need. In application centers in Europe, Asia and North America, system solutions are tested and optimized in accordance with customer specifications. All this makes us a reliable supplier and development partner.

Comprehensive services complete our offering: SICK LifeTime Services provide support throughout the machine life cycle and ensure safety and productivity.

For us, that is “Sensor Intelligence.”

WORLDWIDE PRESENCE:

Contacts and other locations –www.sick.com