

POWER MANAGEMENT

Features

- Input Voltage Range – 1.1V to 3.6V
- 2A Continuous Output Current
- Ultra-Low Ron – 36mΩ
- Automatic Output Discharge Circuit
 - Fast Turn-on Option With No Output Discharge Circuit – SC724
 - Extended Soft Start Option With Automatic Output Discharge Circuit – SC725
- Low Quiescent Current – 0.81μA(Typ.)
- Low Shutdown Current < 1μA – SC724
- 1.1V Logic Level Enable Compatible With CMOS/GPIO Control
- Hardened ESD Protection 3kV
- Package: CSP – 0.76mm × 0.76mm, 0.4mm Pitch

Applications

- Smart Phones
- Tablet PCs
- GPS Devices
- Battery Powered Equipment
- Other Portable Device

Description

The SC724/SC725 is a low input voltage, very low Ron load switch designed for use in battery powered applications. Very low quiescent current of less than 2μA, and a low shutdown current of less than 1μA (SC724) reduces power loss during Standby and Off states. A logic level Enable allows low voltage on/off control down to 1.1V.

The SC724 provides a quick turn on time, while the SC725 provides a longer soft start to limit inrush current. The SC725 also features an automatic discharge circuit which discharges the output when the part is disabled.

The SC724/SC725 is offered in an ultra-small 4-bump 0.76mm × 0.76mm Chip Scale Package (CSP) which enables very small board area implementations. The SC724/SC725 has an operating ambient temperature range of -40°C to +85°C.

SC724/SC725 offers an alternative bump connection pattern to SC724/SC725. Please go to Semtech.com website for details.

Device	Package	Automatic Discharge	Rising Time
SC724	CSP	No	3μs(Typ.)
SC725	CSP	Yes	140μs(Typ.)

Typical Application Circuit

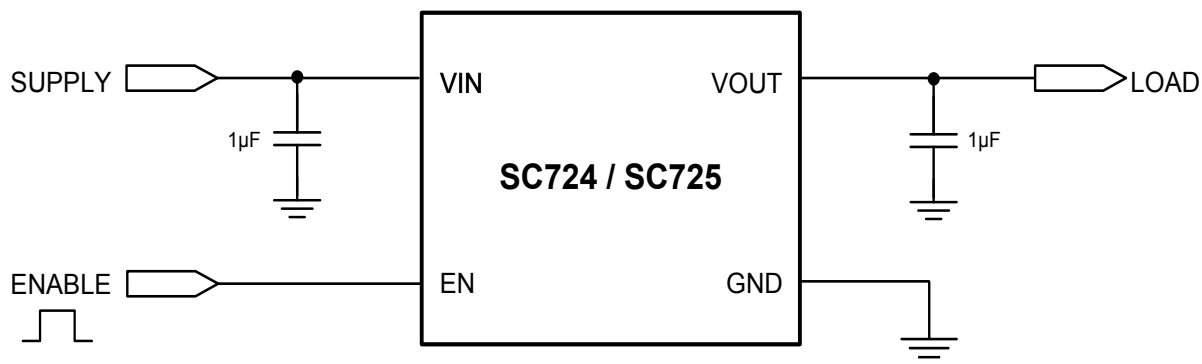

Pin Configuration

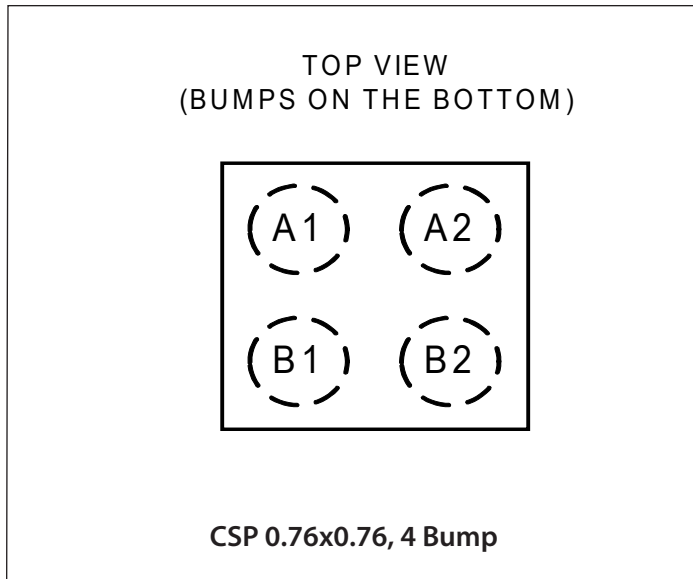

Ordering Information

Device	Package
SC724CSTRT	CSP 0.76mm×0.76mm 4-bump
SC725CSTRT	CSP 0.76mm×0.76mm 4-bump
SC724EVB	Evaluation Board
SC725EVB	Evaluation Board

Notes:

- (1) Available in tape and reel only. A reel contains 5,000 devices.
- (2) Lead-free packaging only. Device is WEEE and RoHS compliant, and halogen free.

Pin Descriptions

Pin #	Pin Name	Pin Function
A1	VIN	Input Voltage.
B1	EN	Enable input. A 5.0MΩ internal resistor is connected from this pin to GND. Drive HIGH to turn on the switch; drive LOW to turn off the switch. When the EN pin is floated, the switch is OFF.
A2	VOUT	Output Voltage.
B2	GND	Ground.

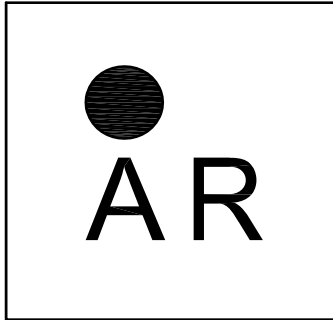
Marking Information(SC724)

Marking for the 0.76 x 0.76 mm CSP 4 Lead Package :

O = Pin 1 ID

nn = Part No. Code (Example: AR) - Reference Part No.

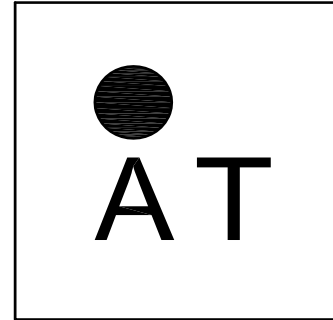
Marking Information(SC725)

Marking for the 0.76 x 0.76 mm CSP 4 Lead Package :

O = Pin 1 ID

nn = Part No. Code (Example: AT) - Reference Part No.

Absolute Maximum Ratings

V _{IN} to GND (V)	-0.3 to +4.3
EN to GND (V).....	-0.3 to +4.3
OUT to GND (V)	-0.3 to +V _{VIN}
ESD Protection Level ⁽¹⁾ (kV)	3

Recommended Operating Conditions

Ambient Temperature Range (°C)	-40 ≤ T _A ≤ +85
V _{VIN} (V).....	1.1 to 3.6
Maximum Output Current (A)	2

Thermal Information

Thermal Resistance, Junction to Ambient ⁽²⁾ (°C/W) ...	160
Maximum Junction Temperature (°C)	+125
Storage Temperature Range (°C).....	-65 to +150
Peak IR Reflow Temperature (10s to 30s) (°C)	+260

Exceeding the above specifications may result in permanent damage to the device or device malfunction. Operation outside of the parameters specified in the Electrical Characteristics section is not recommended.

NOTES:

- (1) Tested according to JEDEC standard JS-001-2012.
- (2) Calculated from package in still air, mounted to 3 x 4.5 (in), 4 layer FR4 PCB with thermal vias under the exposed pad per JESD51 standards.

Electrical Characteristics

Unless noted otherwise, T_A = 25°C for typical, -40°C < T_A = T_J < 85°C for min and max. V_{VIN} = 1.8V, C_{IN} = 1μF, C_{OUT} = 1μF, V_{EN} = V_{VIN}.

Parameter	Symbol	Conditions	Min	Typ	Max	Units
On Resistance (R _{ON})	R _{ON}	V _{VIN} = 3.6V, I _{OUT} = 200mA, V _{EN} = 1.5V		24		mΩ
		V _{VIN} = 2.5V, I _{OUT} = 200mA, V _{EN} = 1.5V		29		mΩ
		V _{VIN} = 1.8V, I _{OUT} = 200mA, V _{EN} = 1.5V		36	47	mΩ
		V _{VIN} = 1.5V, I _{OUT} = 200mA, V _{EN} = 1.5V		43		mΩ
		V _{VIN} = 1.2V, I _{OUT} = 200mA, V _{EN} = 1.0V		57		mΩ
Quiescent Current ⁽¹⁾	I _Q	V _{VIN} = V _{EN} = 3.6V, V _{OUT} = open		0.81	2	μA
Enable						
EN Input High Threshold	V _{EN-H}		1.1			V
EN Input Low Threshold	V _{EN-L}				0.3	V
EN Input Pull-Down Resistance	R _{EN}			5.0		MΩ
SC724						
Shutdown Current	I _{SD}	V _{EN} = 0V, V _{OUT} = open			1	μA
		V _{EN} = 0V, V _{OUT} = open, T _A = 25°C			0.2	μA

Electrical Characteristics (continued)

Parameter	Symbol	Conditions	Min	Typ	Max	Units
Turn-on Delay Time	T_{DT}	$V_{VIN}=1.8V, I_{OUT}=200mA, V_{EN}=1.5V, C_{OUT}=1\mu F$		11		μs
		$V_{VIN}=3.6V, I_{OUT}=200mA, V_{EN}=1.5V, C_{OUT}=1\mu F$		2.8		μs
Rising Time	T_{RT}	$V_{VIN}=1.8V, I_{OUT}=200mA, V_{EN}=1.5V, C_{OUT}=1\mu F$		8.5		μs
		$V_{VIN}=3.6V, I_{OUT}=200mA, V_{EN}=1.5V, C_{OUT}=1\mu F$		3		μs

SC725

Shutdown Current	I_{SD}	$V_{EN}=0V, V_{OUT} = \text{open}$			8	μA
		$V_{EN}=0V, V_{OUT} = \text{open}, T_A = 25^\circ C$			0.6	μA
Turn-on Delay Time	T_{DT}	$V_{VIN}=1.8V, I_{OUT}=200mA, V_{EN}=1.5V, C_{OUT}=1\mu F$		240		μs
		$V_{VIN}=3.6V, I_{OUT}=200mA, V_{EN}=1.5V, C_{OUT}=1\mu F$		110		μs
Rising Time	T_{RT}	$V_{VIN}=1.8V, I_{OUT}=200mA, V_{EN}=1.5V, C_{OUT}=1\mu F$		250		μs
		$V_{VIN}=3.6V, I_{OUT}=200mA, V_{EN}=1.5V, C_{OUT}=1\mu F$		140		μs
Output Pull-Down Resistance	R_{PD}	$V_{VIN}=1.8V$		220		Ω

Notes:

 (1) I_Q current includes EN pull-down current.

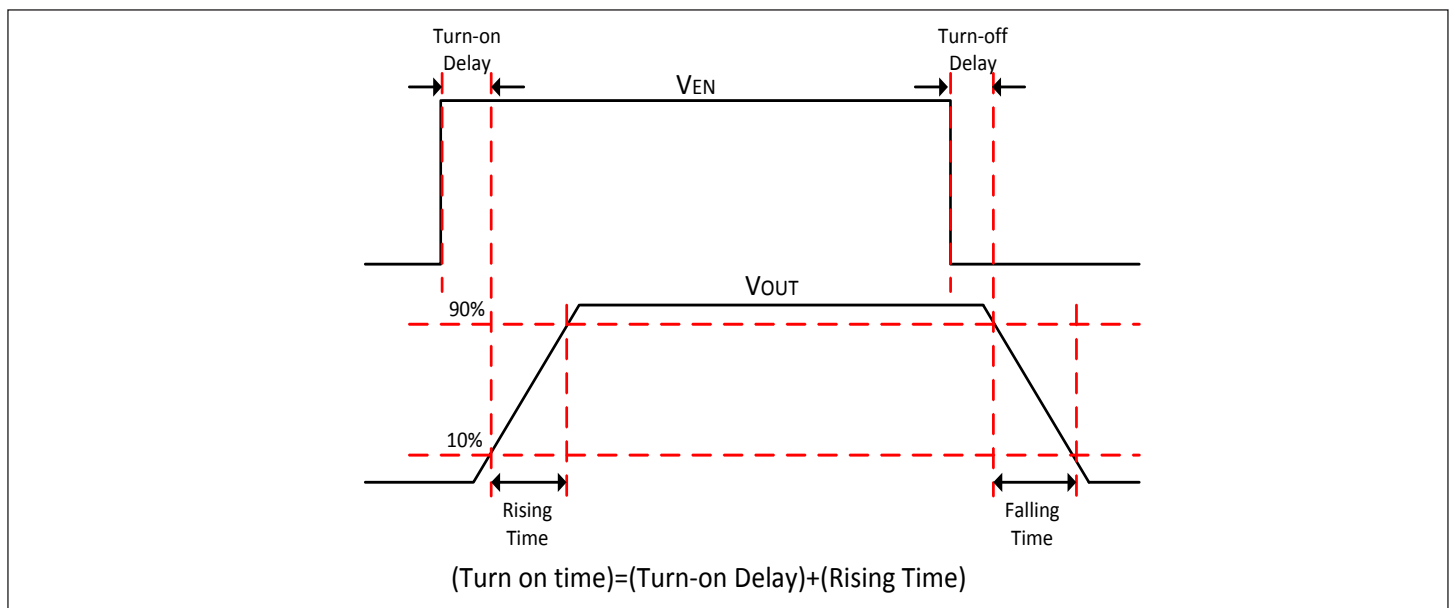
Timing Diagram

Typical Characteristics (SC724)

Start Up by VIN

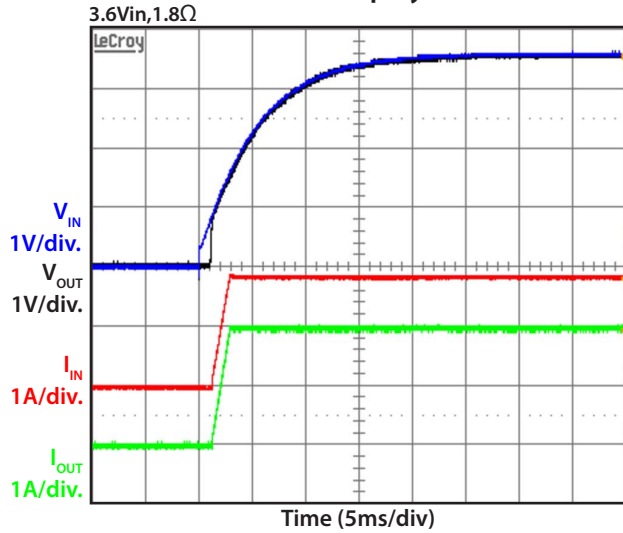

Shut Down by VIN

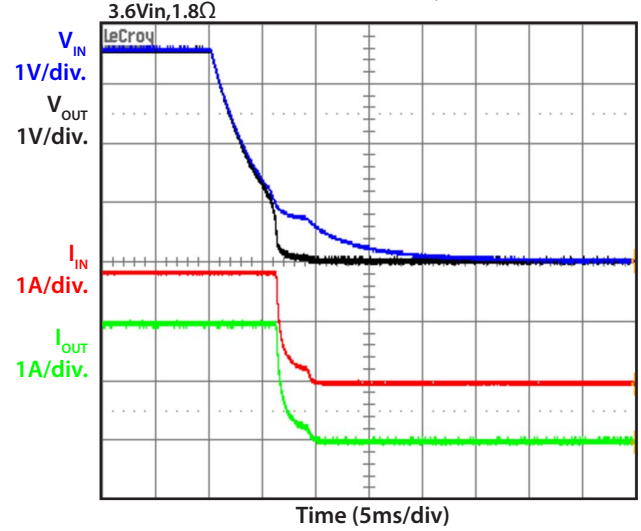

Start Up by EN

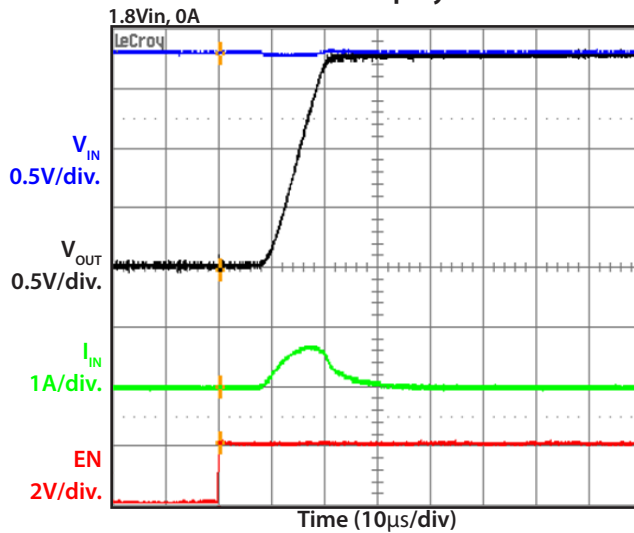

Start Up by EN

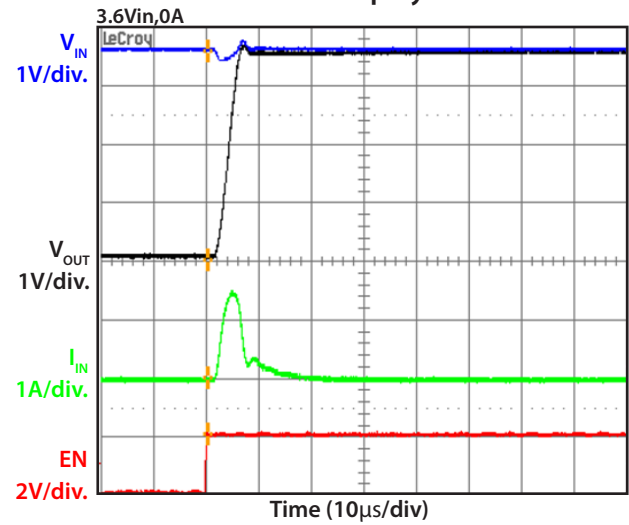

Shut Down by EN

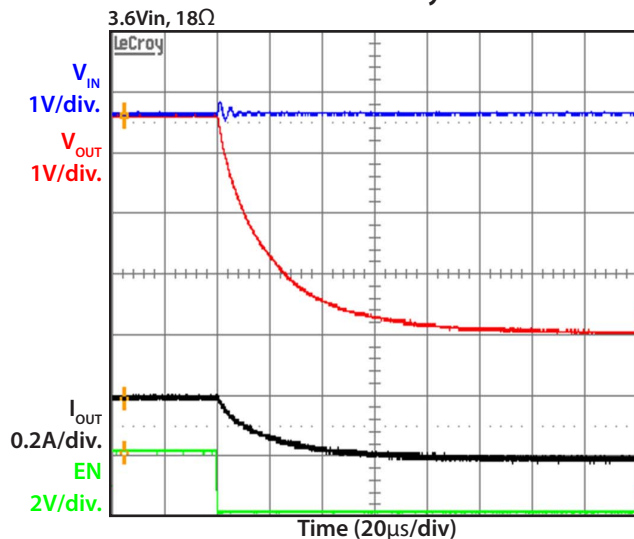

Typical Characteristics (SC724), Cont.

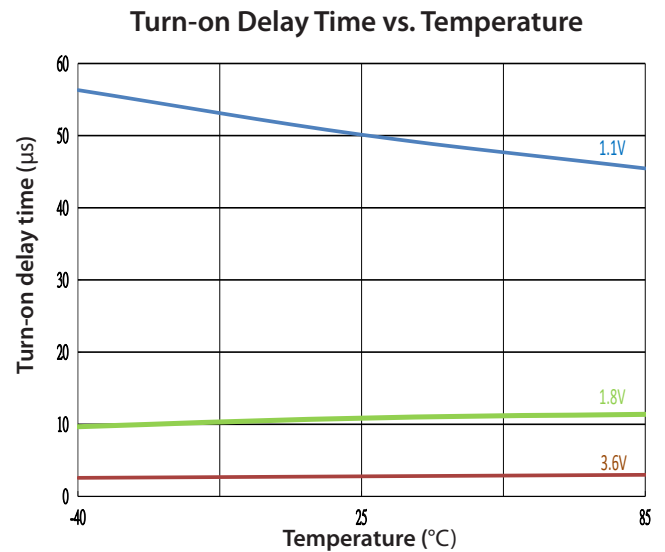
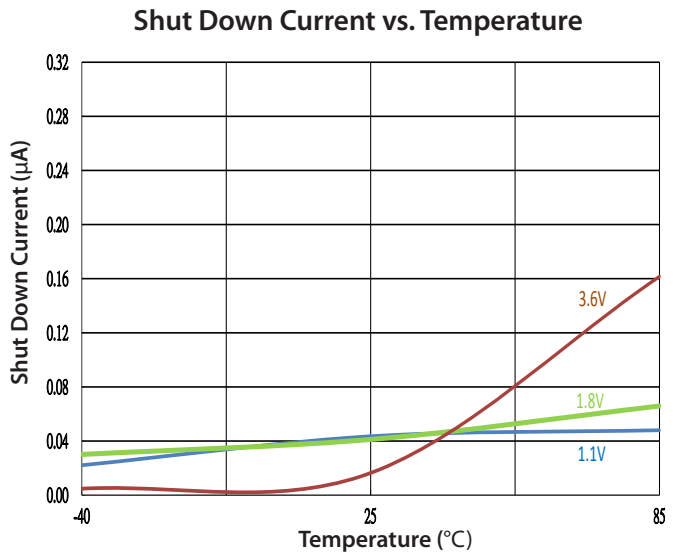
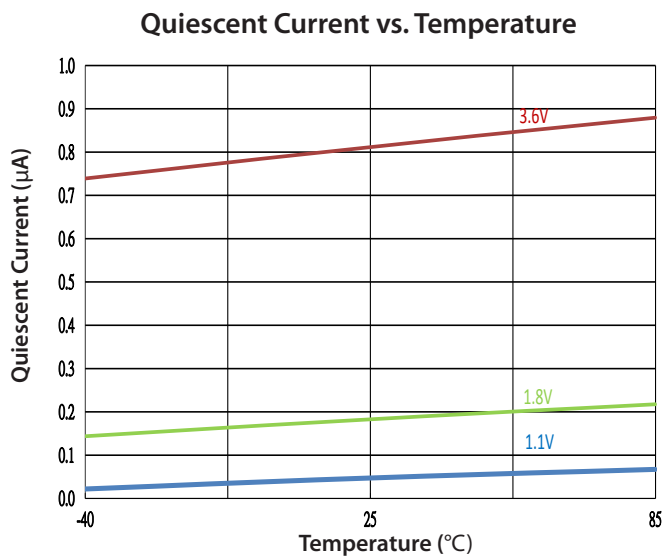
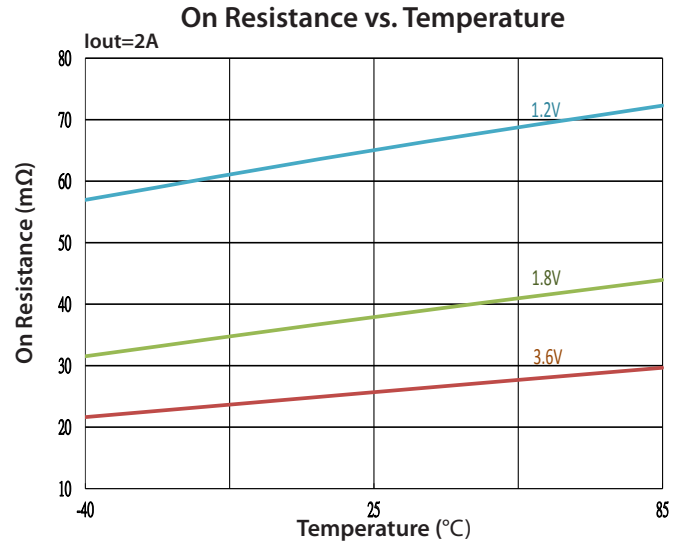
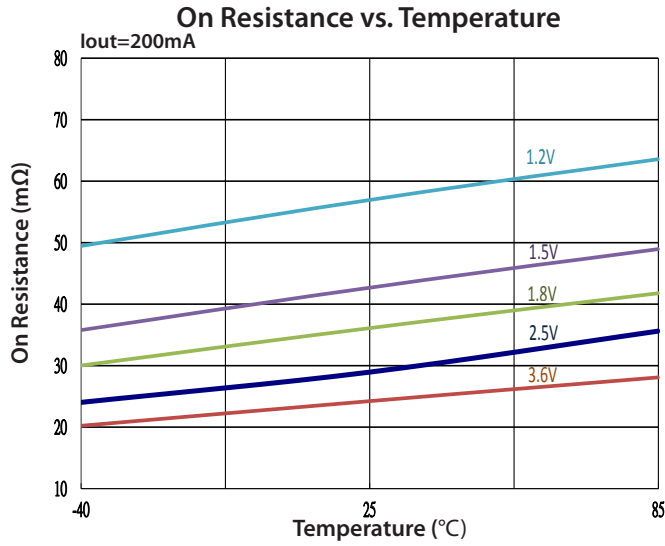

Typical Characteristics (SC725)

Start Up by VIN

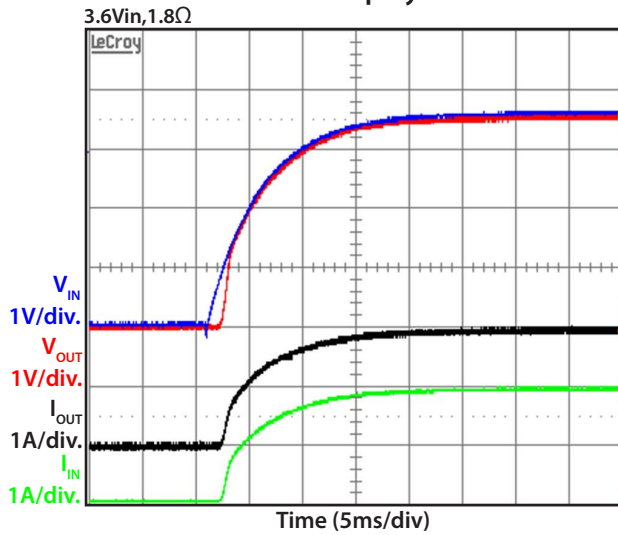

Shut Down by VIN

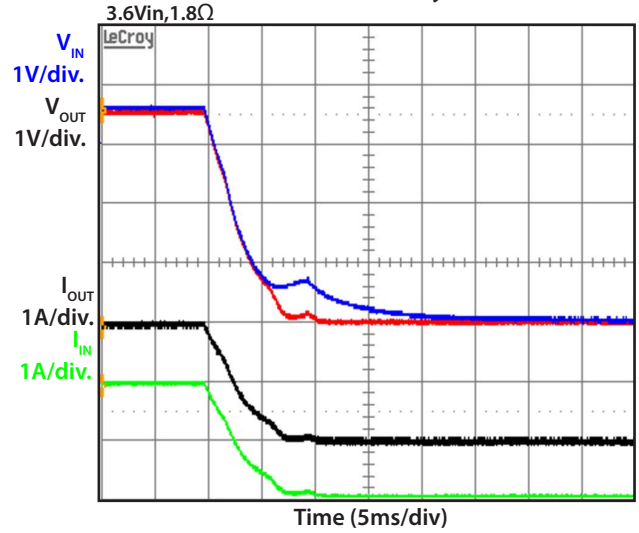

Start Up by EN

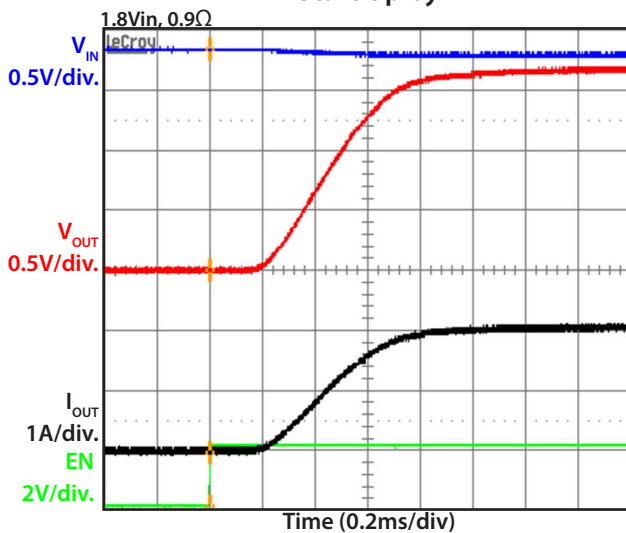

Start Up by EN

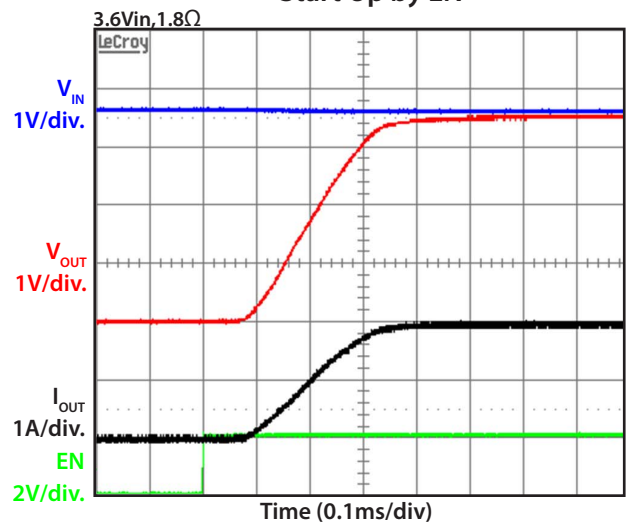

Shut Down by EN

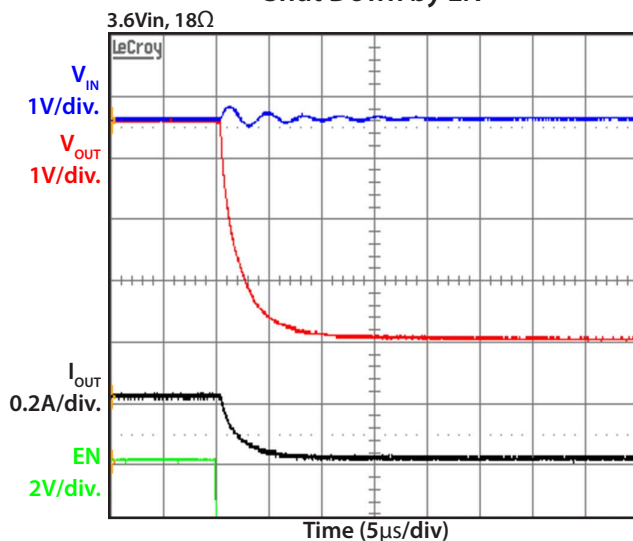

EN High Threshold vs. Temperature

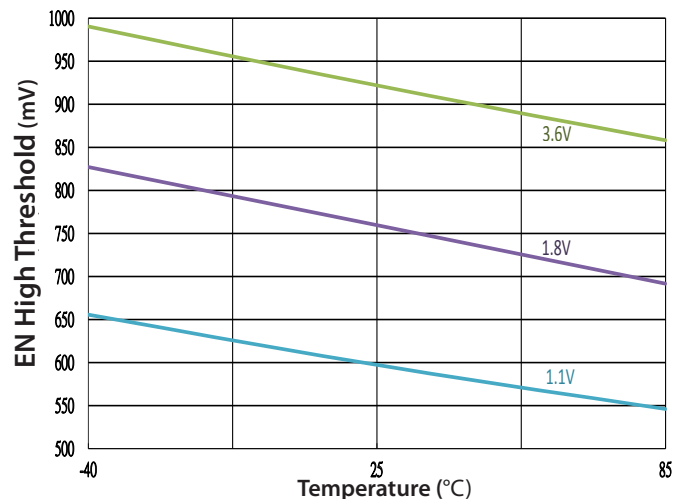

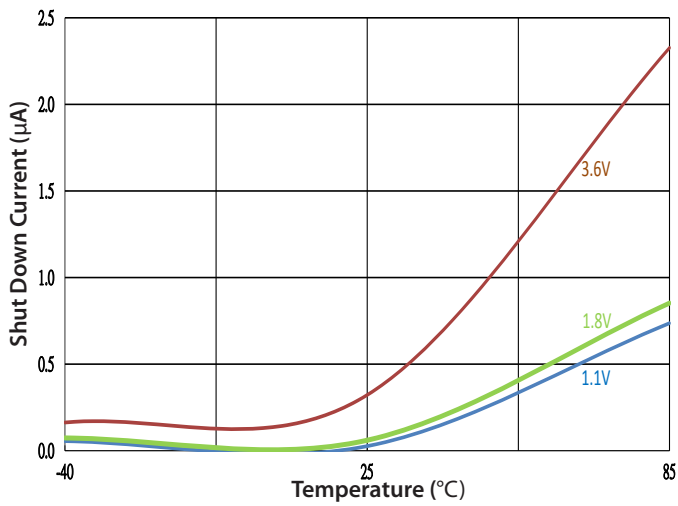
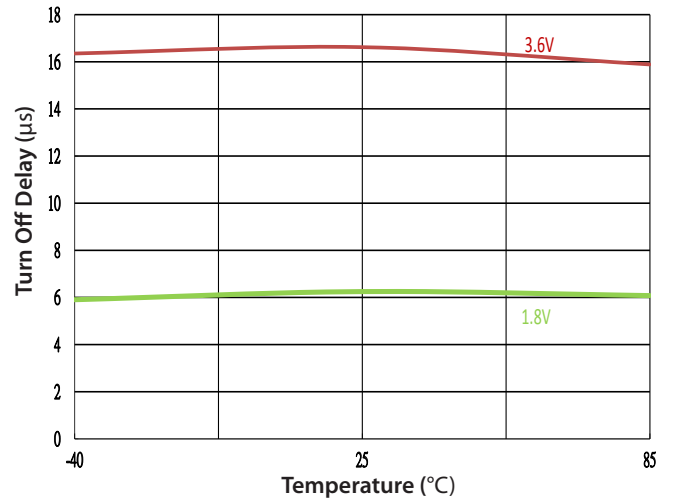
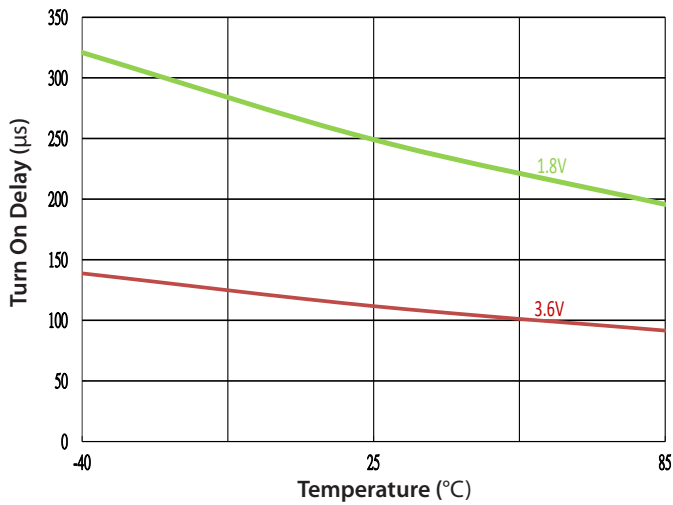
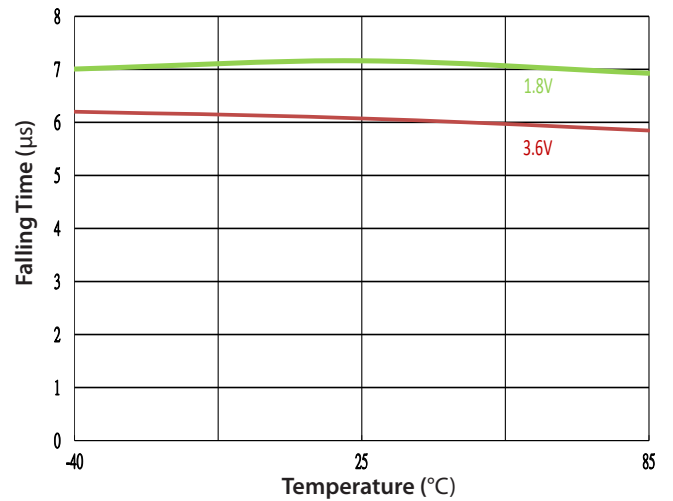
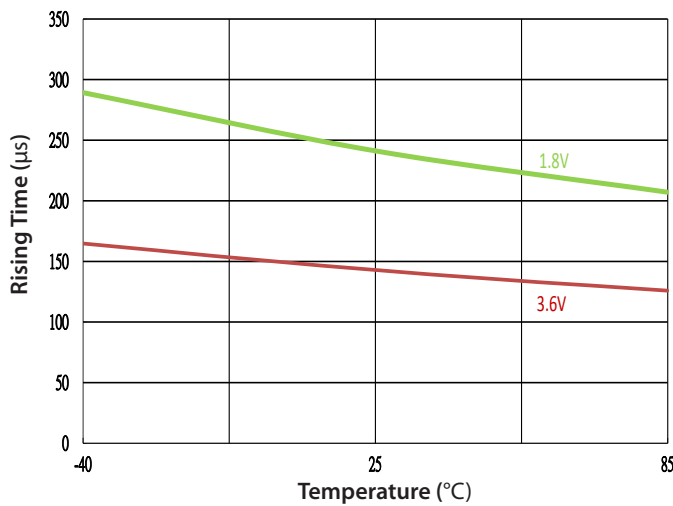
Typical Characteristics (SC725), Cont.
Shut Down Current vs. Temperature

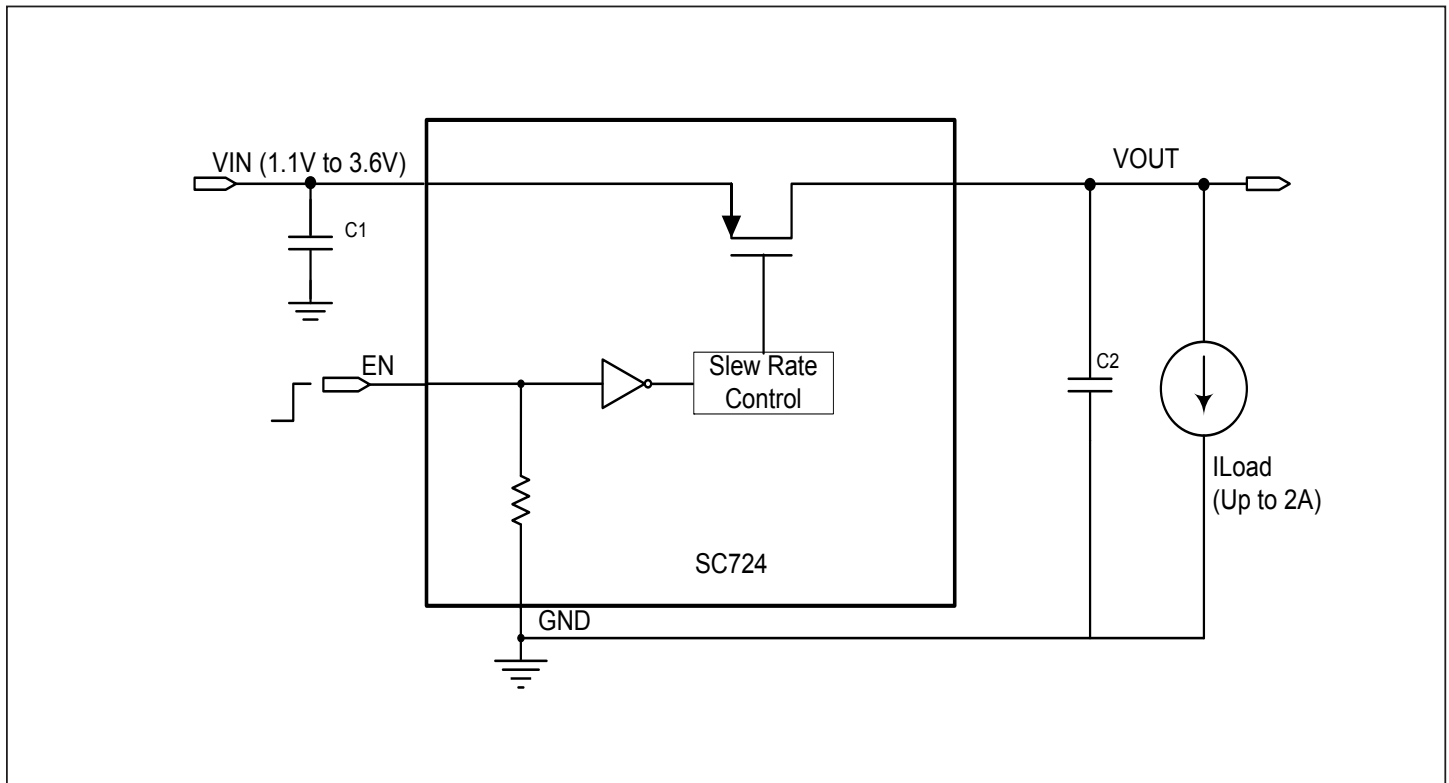
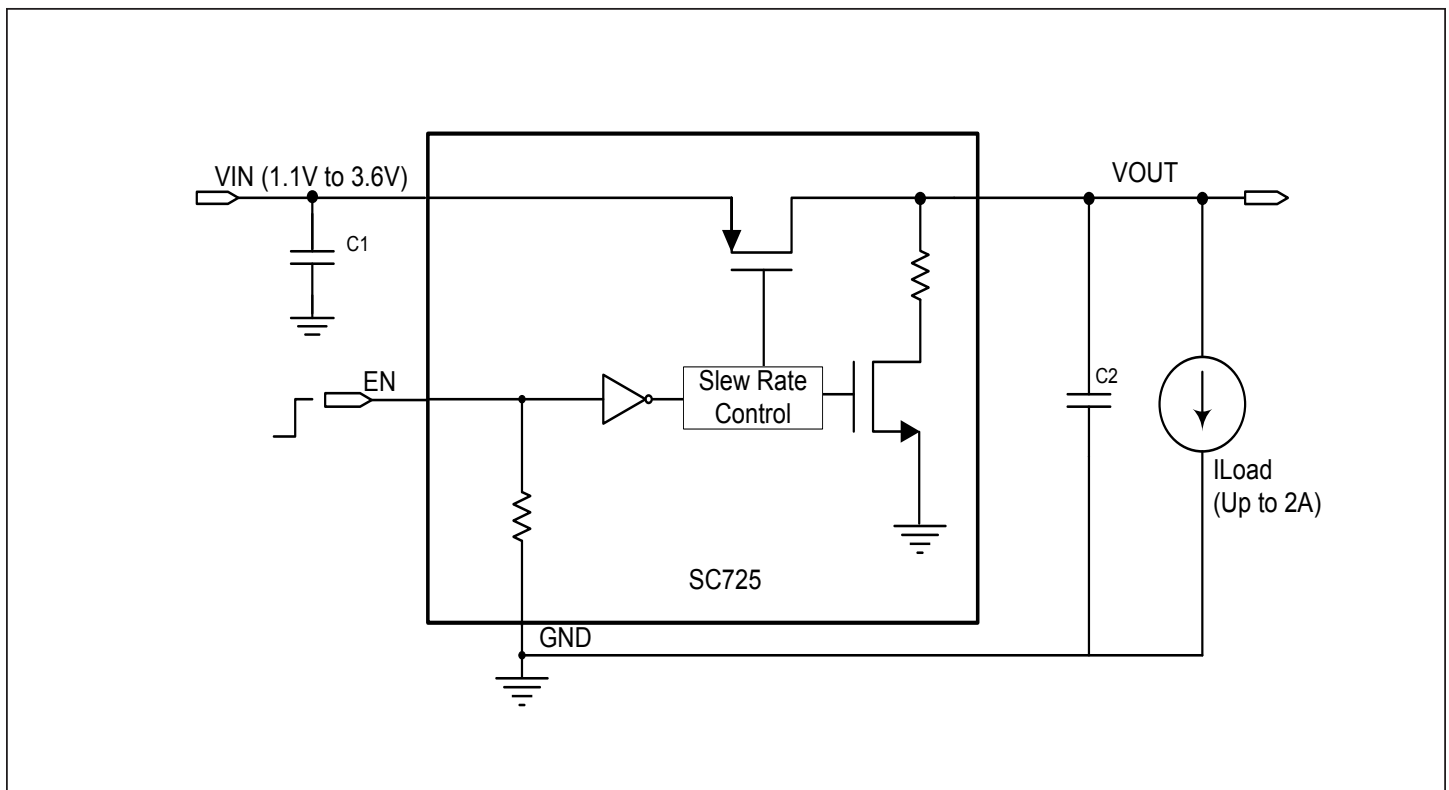
Turn-off Delay vs. Temperature

Turn-on Delay vs. Temperature

Falling Time vs. Temperature

Rising Time vs. Temperature

Block Diagram
SC724

SC725

Application Information

Operation

The SC724/SC725 is an integrated high-side PMOS load switch that is designed to support up to 2A continuous output current and operate from an input voltage from 1.1V to 3.6V. The internal PMOS pass element has a very low ON resistance of 36mΩ (typical) at $V_{IN} = 1.8V$. The SC724/SC725 also provides ultra-low shutdown and quiescent current for extended battery life during application off and standby states.

SC725 provides longer Turn-on Delay Time and Rising Time, which can help reduce inrush current and voltage drop on the input supply rail during power on.

SC724 provides shorter Turn-on Delay and Rising Time for applications where immediate response is required.

Output Voltage Pull-down

The SC725 also includes an automatic output discharge function. It employs a 220Ω (typical) discharge path to ground when the EN pin is disabled.

Enable

The EN pin controls the ON/OFF states of the load switch. Pulling the EN pin HIGH turns on the load switch. Pulling the EN pin LOW turns off the load switch. The EN pin incorporates a 5.0MΩ (typical) pull-down resistor, so that when the EN pin is floating the SC724/SC725 is disabled.

Input Capacitor

In order to reduce the effects of voltage drop, noise, and bounce at the VIN pin, a filter/decoupling capacitor between VIN to GND is recommended. A 1μF ceramic capacitor is sufficient for most application conditions. However, it should be noted that suppressing bounce at input loop after EN is changed from HIGH to LOW can require greater capacitor values depending on particular designs. During certain shutdown conditions, as in the case when input power supply is abruptly removed, the input voltage may tend to drop faster than the output voltage. In this event a reverse current, through the body diode of internal PMOS FET, from VOUT to VIN can occur. To limit this reverse current, the Cin value should be selected greater than the Cout value.

Output Capacitor

A 1μF ceramic capacitor is normally used at the VOUT pin to suppress output noise and provide smooth voltage to the load. If a larger output capacitance value is used, the input inrush current should be considered because the power-on transient is also dependent on the output capacitor value. Note that SC725 has longer Turn-on Delay Time and Rising Time than SC724. If a larger output capacitor is used, SC725 could significantly improve input inrush current during power-on process.

Board Layout Considerations

Fig. 1 shows a typical application circuit with PCB inductance on the circuit board. An important objective of the layout is to minimize the PCB inductance by reducing the length and increasing the width of the traces. The input capacitor C1 and output capacitor C2 need to be placed close to the SC724/SC725. To analyze the stray inductance, Fig. 1 shows three current loops during the opening or closing of the load switch. The magnitude of the voltage ringing at VIN or VOUT pin is related to the PCB stray inductance and the placement of the capacitors. It is important to keep the voltage ringing below the maximum voltage rating of the SC724/SC725.

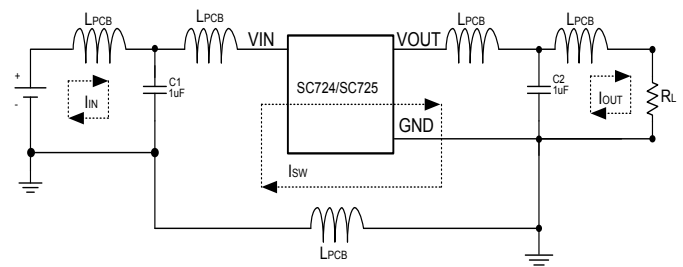

Figure 1 - PCB Circuit with Equivalent Parasitic Inductance

Evaluation Board Information

The Top Layer and Bottom Layer of a standard evaluation board are shown in Fig. 2 and Fig. 3, respectively.

Both T1 and T2 test points are Kelvin connections which can be used to minimize the measurement error of R_{ON} . To enable the part, a jumper can be used between VIN and EN on J1. To disable the part, a jumper can be connected between EN and GND on J1.

Top Layer

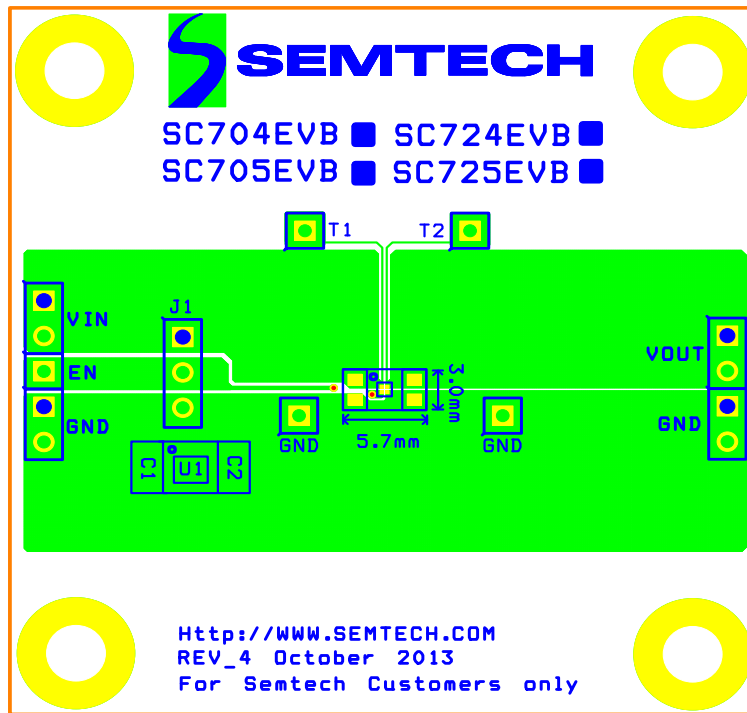

Figure 2

Bottom Layer

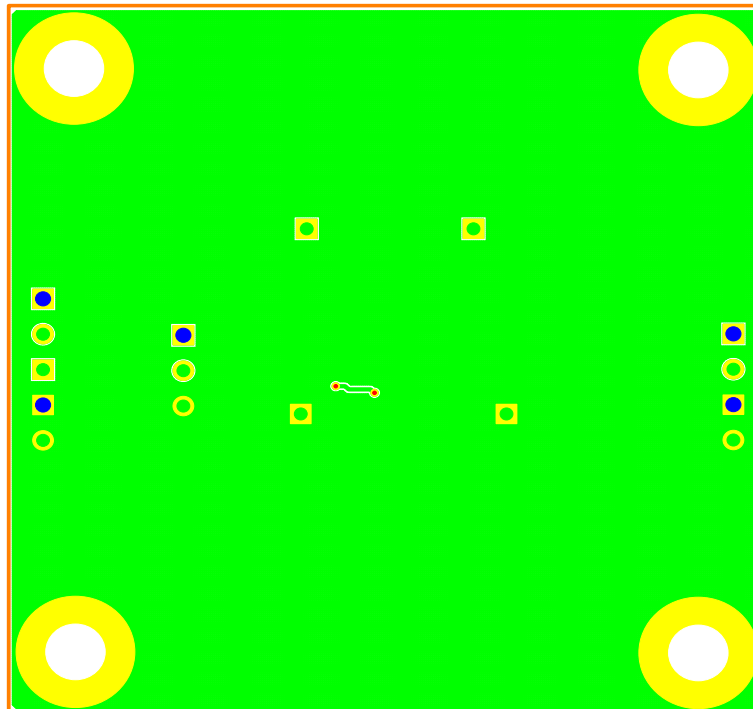
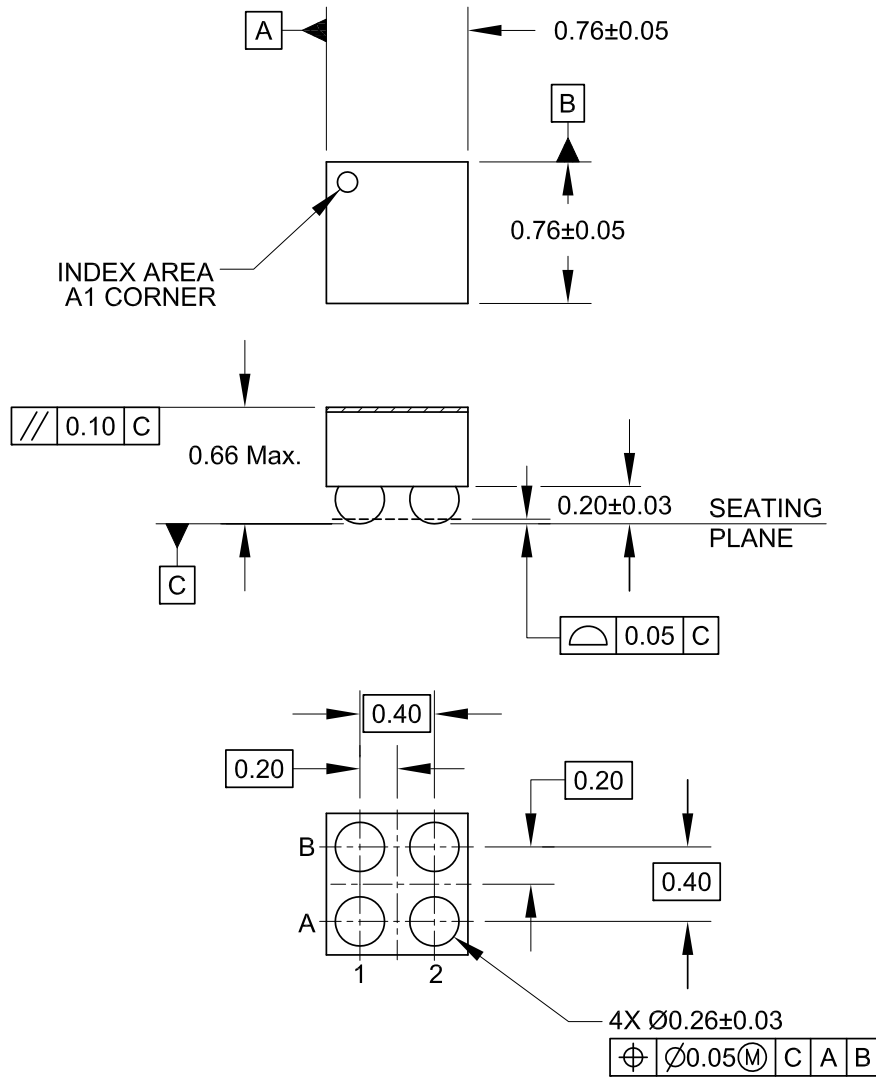
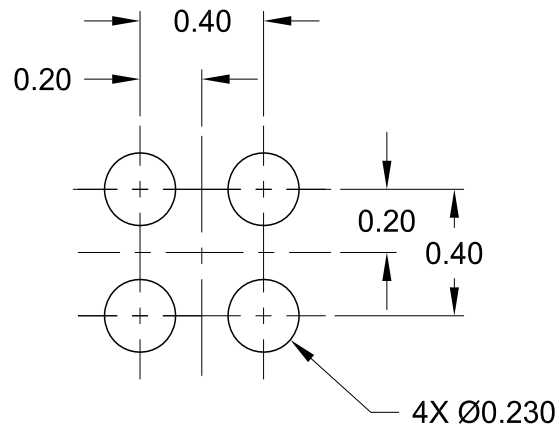

Figure 3

Outline Drawing — CSP 0.76mm X 0.76mm, 4 Lead

NOTES:

1. CONTROLLING DIMENSIONS ARE IN MILLIMETERS

Land Pattern — CSP 0.76mm X 0.76mm, 4 Lead**NOTES:**

1. CONTROLLING DIMENSIONS ARE IN MILLIMETERS
2. THIS LAND PATTERN IS FOR REFERENCE PURPOSES ONLY.
CONSULT YOUR MANUFACTURING GROUP TO ENSURE YOUR
COMPANY'S MANUFACTURING GUIDELINES ARE MET.

© Semtech 2014

All rights reserved. Reproduction in whole or in part is prohibited without the prior written consent of the copyright owner. The information presented in this document does not form part of any quotation or contract, is believed to be accurate and reliable and may be changed without notice. No liability will be accepted by the publisher for any consequence of its use. Publication thereof does not convey nor imply any license under patent or other industrial or intellectual property rights. Semtech assumes no responsibility or liability whatsoever for any failure or unexpected operation resulting from misuse, neglect improper installation, repair or improper handling or unusual physical or electrical stress including, but not limited to, exposure to parameters beyond the specified maximum ratings or operation outside the specified range.

SEMTECH PRODUCTS ARE NOT DESIGNED, INTENDED, AUTHORIZED OR WARRANTED TO BE SUITABLE FOR USE IN LIFE-SUPPORT APPLICATIONS, DEVICES OR SYSTEMS OR OTHER CRITICAL APPLICATIONS. INCLUSION OF SEMTECH PRODUCTS IN SUCH APPLICATIONS IS UNDERSTOOD TO BE UNDERTAKEN SOLELY AT THE CUSTOMER'S OWN RISK. Should a customer purchase or use Semtech products for any such unauthorized application, the customer shall indemnify and hold Semtech and its officers, employees, subsidiaries, affiliates, and distributors harmless against all claims, costs damages and attorney fees which could arise.

Notice: All referenced brands, product names, service names and trademarks are the property of their respective owners.

Contact Information

Semtech Corporation
Power Management Products Division
200 Flynn Road, Camarillo, CA 93012
Phone: (805) 498-2111 Fax: (805) 498-3804

www.semtech.com