

REV.	EC#	DESCRIPTION	DATE	DRAWN	CHECK	APPROVED
1.00		行发版初	2018-04-22			

16	37.50	40.80
15	35.00	38.30
14	32.50	35.80
13	30.00	33.30
12	27.50	30.80
11	25.00	28.80
10	22.50	25.80
9	20.00	23.30
8	17.50	20.80
7	15.00	18.30
6	12.50	15.80
5	10.00	13.30
4	7.50	10.80
3	5.00	8.30
2	2.50	5.80
Pin	DIM.A	DIM.B

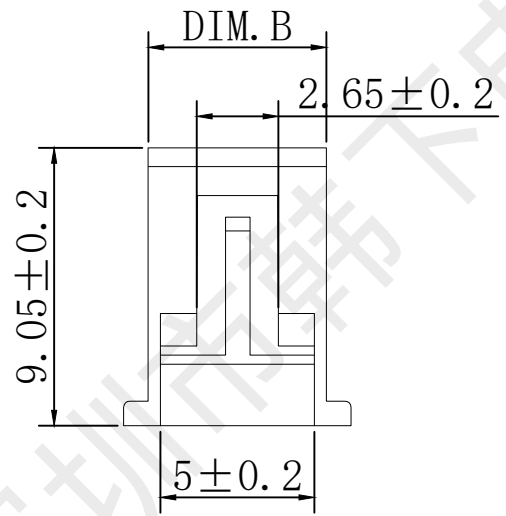
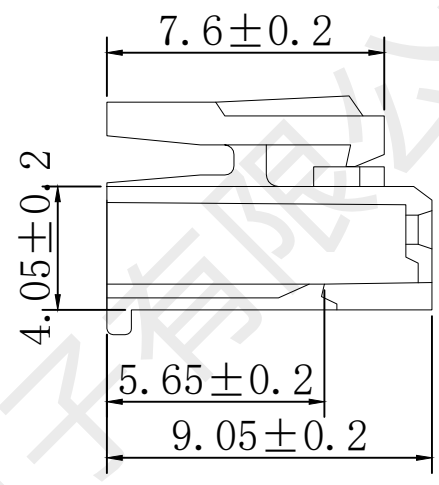
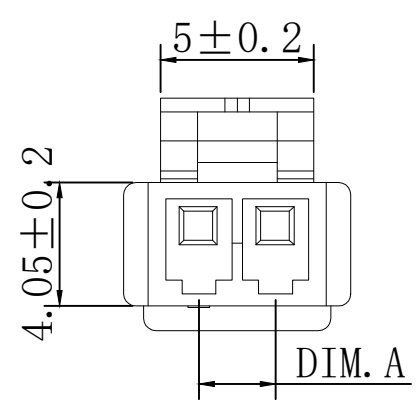

- 1.工作温度: -25°C~85°C.
- 2.适用线规: AWG#28~#22.
- 3.额定电压: 250V DC/AC(rms).
- 4.额定电流: 3.0A.
- 5.接触电阻: ≤20mΩ.
- 6.耐压值: 1000V AC/minute.
- 7.绝缘电阻: ≥1000MΩ.
- 8.适用基板厚度: 1.6MM

技术要求:

- 1) 材质: 见附表;
- 2) 电镀: 见附表;
- 3) 塑件表面平整、光洁、无毛刺、气泡、烧焦、变形、浇口无拉伤、多料或缺料等不良现象;
- 4) 端子表面无氧化、电镀不良等现象。

GENERAL TOLERANCES		
DIM TOL	DIM	DEG
X.	X°	±3.00°
X.X	X.X°	±2.00°
X.XX	X.XX°	±1.00°
X.XXX	X.XXX°	

1	Housing	1 PCS	材质:PA66 (UL94V-0),颜色:本色		
NO.	NAME	Q'TY	DESCRIPTION		
 深圳市首韩科技有限公司					
DRAW :	黄彬	2018-04-22	TITLE:	压线端子胶壳	
DESIGN:			DRAWNAME:	HX XHB2.54-4Y	
CHECK:	张伟	2018-04-22	SERIES:	2.5XHB SERIES	
APPROVED	罗小春	2018-04-22	P/N:		
CUSTOMER DRAWING			REV. 1.00	SCALE N/A	UNIT: mm
			SHEET:	1/1	+