

BCZ65N45M1

N-Channel Silicon Carbide Power MOSFET

650 V, 42 A, 45 mΩ



bestirpower

Features

- High switching speed with a low gate charge
- Fast intrinsic diode with low reverse recovery
- Robust Avalanche Capability
- 100% Avalanche Tested
- Halogen Free, and RoHS Compliant

$BV_{DSS, T_C=25^\circ C}$	$I_D, T_C=25^\circ C$	$R_{DS(on), typ}$	$Q_{g, typ}$
650 V	44 A	45 mΩ	55 nC

Benefits

- System efficiency improvement
- Higher frequency applicability
- Increased power density
- Reduced cooling effort

Applications

- Solar inverter / ESS / UPS
- EV charging station
- Server & Telecom power
- Industrial power supply

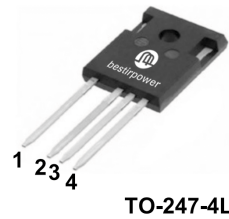

TO-247-4L

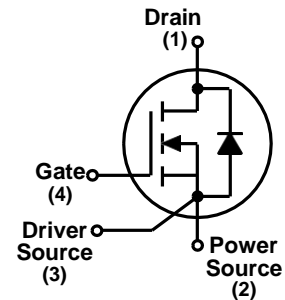

Absolute Maximum Ratings ($T_J = 25^\circ C$ unless otherwise noted)

Symbol	Parameter	Value	Unit	
V_{DSS}	Drain to Source Voltage	650	V	
V_{GS}	Gate to Source Voltage (DC)	-10 / +22	V	
V_{GSop}	Recommended Operation Value	-5 / +18	V	
I_D	Drain Current	$V_{GS} = 18 V, (T_C = 25^\circ C)$	44	A
		$V_{GS} = 18 V, (T_C = 100^\circ C)$	31	
I_{DM}	Drain Current	Pulsed (Note1)	117	A
P_D	Power Dissipation	$(T_C = 25^\circ C)$	150	W
		Derate Above 25°C	1.0	W/°C
T_J, T_{STG}	Operating and Storage Temperature Range	-55 to 175	°C	

※Note 1 : Limited by maximum junction temperature.

Thermal Characteristics

Symbol	Parameter	Value	Unit
$R_{\theta JC}$	Thermal Resistance, Junction to Case, Max.	1.0	°C/W
$R_{\theta JA}$	Thermal Resistance, Junction to Ambient, Max.	40	
T_{sold}	Soldering temperature, wave soldering only allowed at leads	260	°C

Electrical Characteristics ($T_J = 25^\circ\text{C}$ unless otherwise noted)

Symbol	Parameter	Test Conditions	Min	Typ	Max	Unit
Off Characteristics						
BV_{DSS}	Drain to Source Breakdown Voltage	$V_{GS} = 0\text{ V}, I_D = 1\text{ mA}$	650	-	-	V
I_{DSS}	Zero Gate Voltage Drain Current	$V_{DS} = 650\text{ V}, V_{GS} = 0\text{ V}$	-	1	100	μA
		$V_{DS} = 650\text{ V}, V_{GS} = 0\text{ V}, T_J = 175^\circ\text{C}$	-	10	-	
I_{GSS}	Gate-Source Leakage Current	$V_{GS} = +22\text{ V}, V_{DS} = 0\text{ V}$	-	-	+100	nA
		$V_{GS} = -10\text{ V}, V_{DS} = 0\text{ V}$	-	-	-100	

On Characteristics

$V_{GS(th)}$	Gate Threshold Voltage	$V_{GS} = V_{DS}, I_D = 7\text{ mA}$	1.8	2.8	4.5	V
$R_{DS(on)}$	Static Drain to Source On Resistance	$V_{GS} = 18\text{ V}, I_D = 20\text{ A}$	-	45	63	$\text{m}\Omega$
		$V_{GS} = 18\text{ V}, I_D = 20\text{ A}, T_J = 175^\circ\text{C}$	-	59	-	
g_{fs}	Transconductance	$V_{DS} = 20\text{ V}, I_D = 20\text{ A}$	-	13.4	-	S

Dynamic Characteristics

C_{iss}	Input Capacitance	$V_{DS} = 400\text{ V}, V_{GS} = 0\text{ V}, f = 1\text{ MHz}$	-	1048	-	pF
C_{oss}	Output Capacitance		-	131	-	
C_{rss}	Reverse Capacitance		-	9.1	-	
E_{oss}	Stored Energy in Output Capacitance	$V_{DS} = 0\text{ V to } 400\text{ V}, V_{GS} = 0\text{ V}$	-	13.0	-	μJ
$C_{o(er)}$	Energy Related Output Capacitance		-	162.0	-	pF
$C_{o(tr)}$	Time Related Output Capacitance		-	236	-	
$Q_{g(tot)}$	Total Gate Charge	$V_{DS} = 400\text{ V}, I_D = 20\text{ A},$ $V_{GS} = -5\text{ V} / 18\text{ V},$ Inductive load	-	56	-	nC
Q_{gs}	Gate to Source Charge		-	14	-	
Q_{gd}	Gate to Drain "Miller" Charge		-	15	-	
R_G	Internal Gate Resistance	$f = 1\text{ MHz}, V_{AC} = 30\text{ mV}$ open drain	-	4.0	-	Ω

Switching Characteristics

$t_{d(on)}$	Turn-On Delay Time	$V_{DS} = 400\text{ V}, I_D = 20\text{ A},$ $V_{GS} = -5\text{ V} / 18\text{ V}, R_G = 2\ \Omega,$ FWD : BCH65S012D1, Inductive load	-	13	-	ns
t_r	Turn-On Rise Time		-	10	-	
$t_{d(off)}$	Turn-Off Delay Time		-	26	-	
t_f	Turn-Off Fall Time		-	5	-	
E_{on}	Turn-on Switching Energy		-	27	-	μJ
E_{off}	Turn-off Switching Energy		-	18	-	
E_{tot}	Total Switching Energy		-	45	-	

Source-Drain Diode Characteristics

I_S	Maximum Continuous Diode Forward Current	-	-	42	A	
I_{SM}	Maximum Pulsed Diode Forward Current	-	-	117		
V_{SD}	Diode Forward Voltage	$V_{GS} = -5\text{ V}, I_{SD} = 20\text{ A}$	-	4.2	-	V
t_{rr}	Reverse Recovery Time	$V_{DD} = 400\text{ V}, I_{SD} = 20\text{ A},$ $di_f/dt = 1000\text{ A}/\mu\text{s}$, Includes Q_{OSS}	-	17	-	ns
Q_{rr}	Reverse Recovery Charge		-	104	-	nC
I_{rrm}	Peak Reverse Recovery Current		-	10	-	A

Typical Performance Characteristics

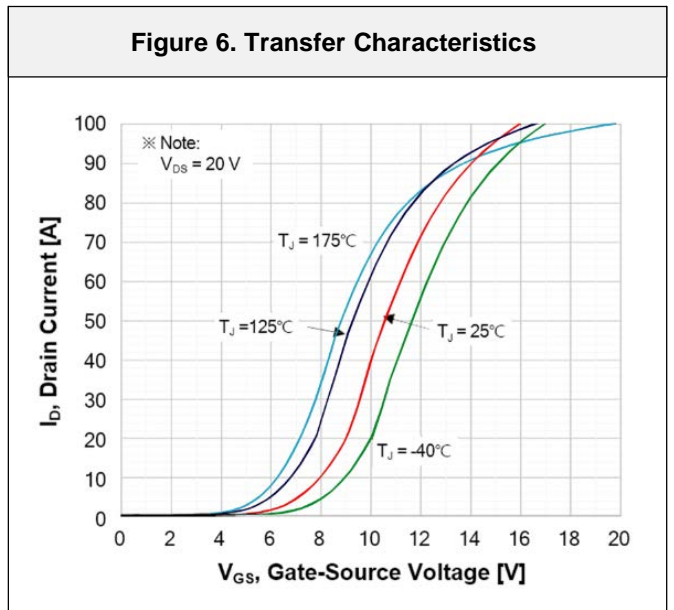
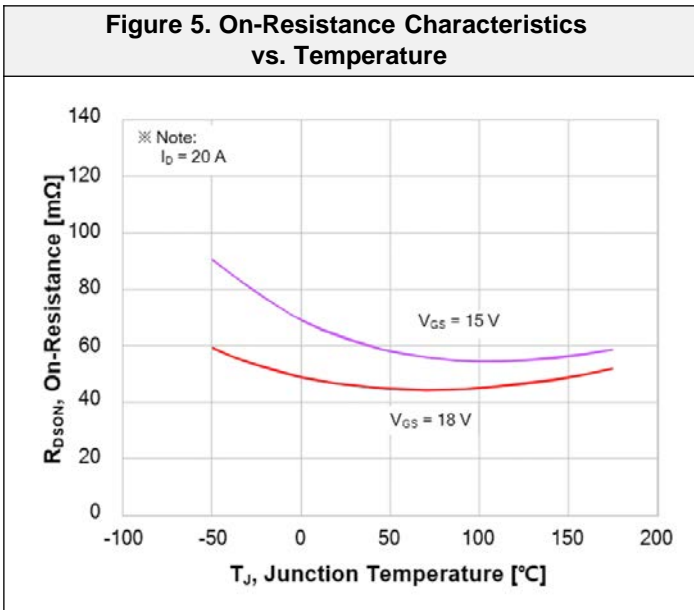
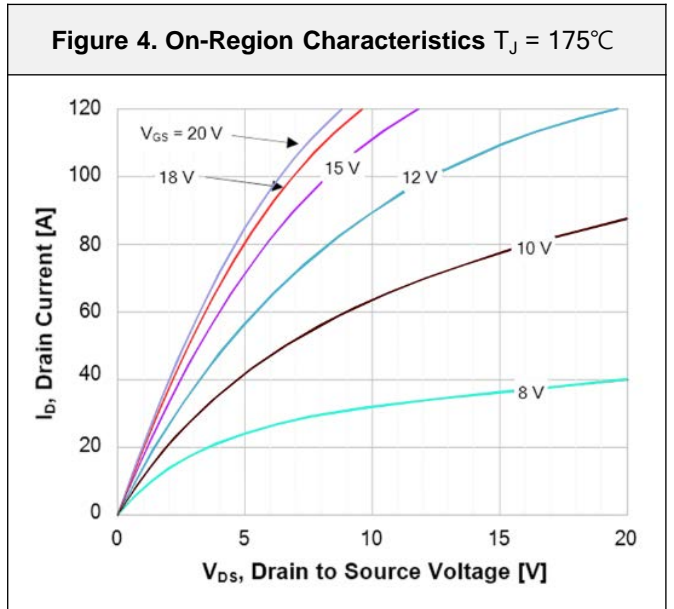
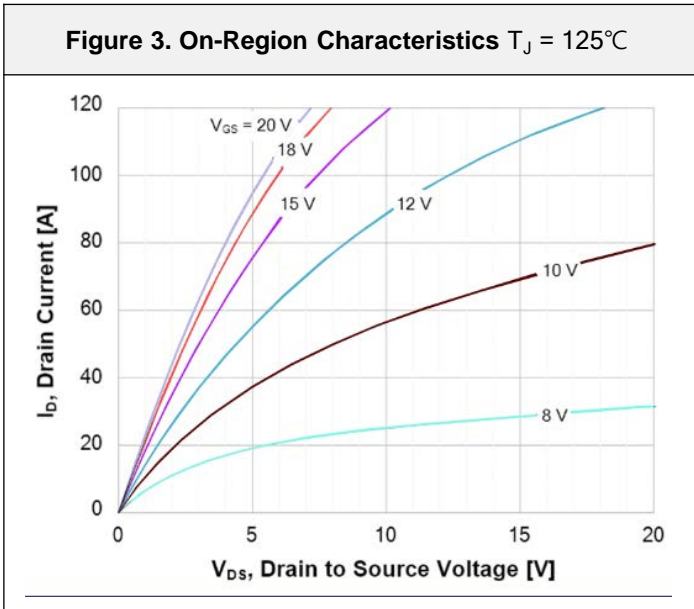
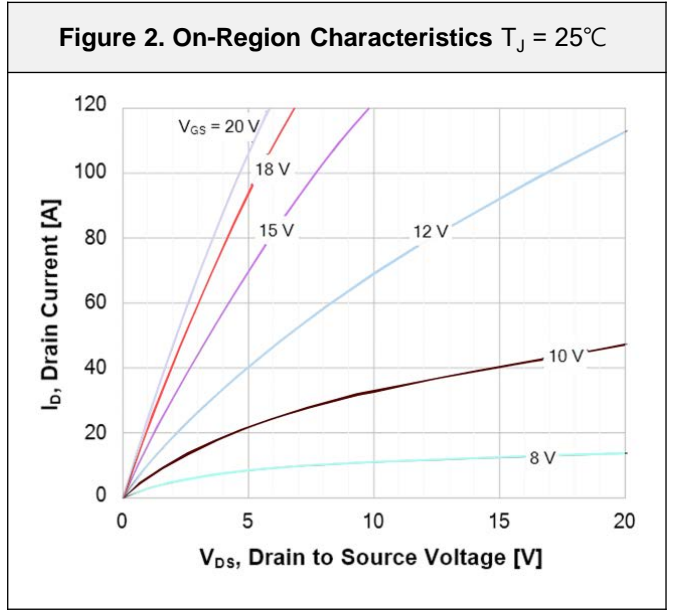
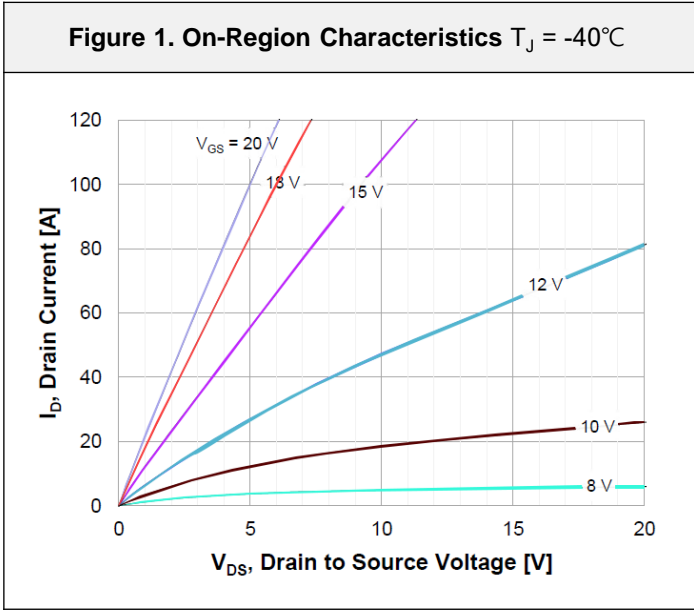

Typical Performance Characteristics

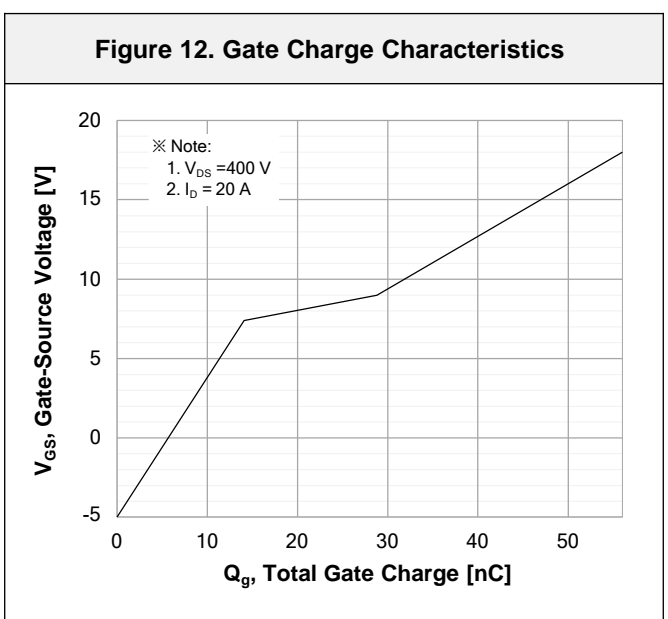
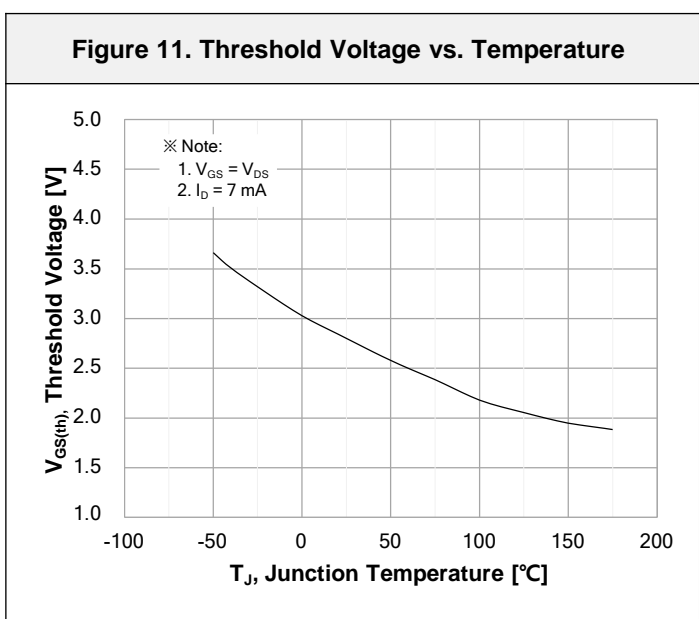
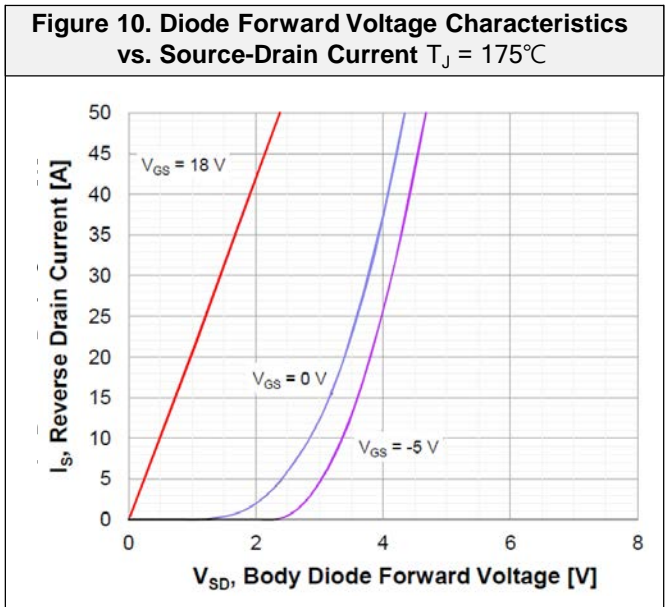
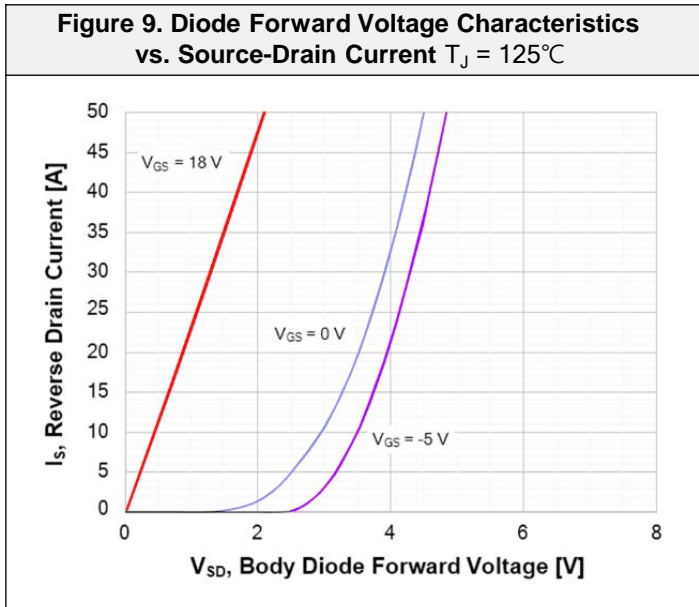
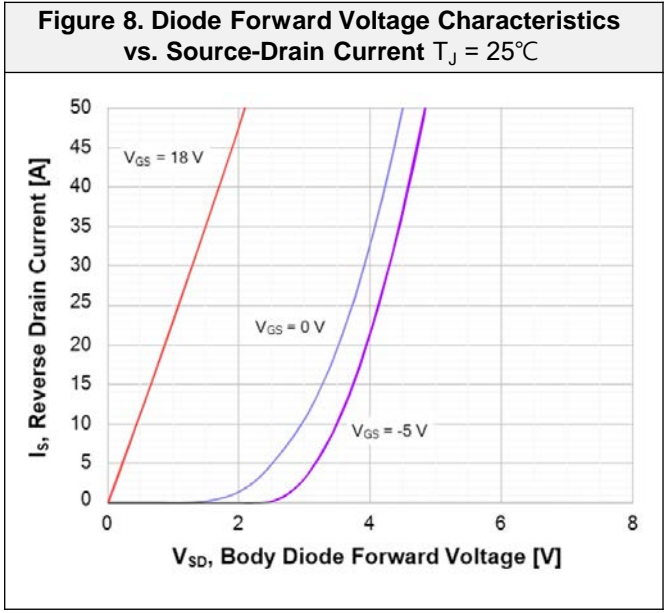
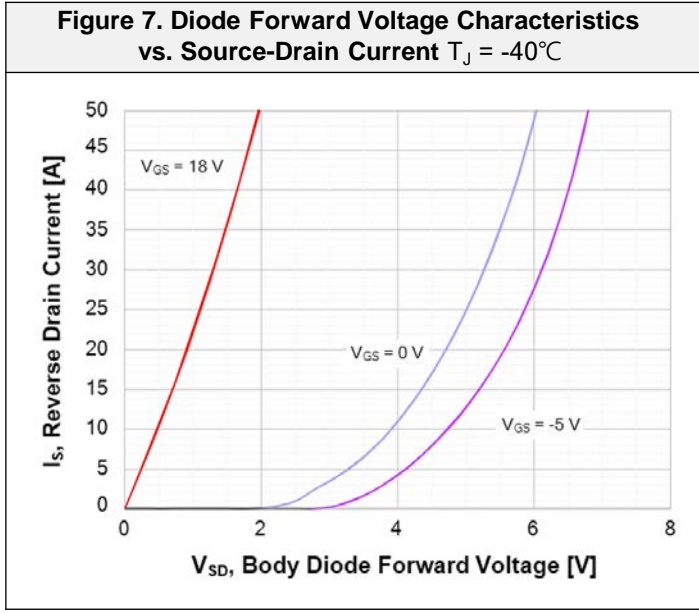

Typical Performance Characteristics

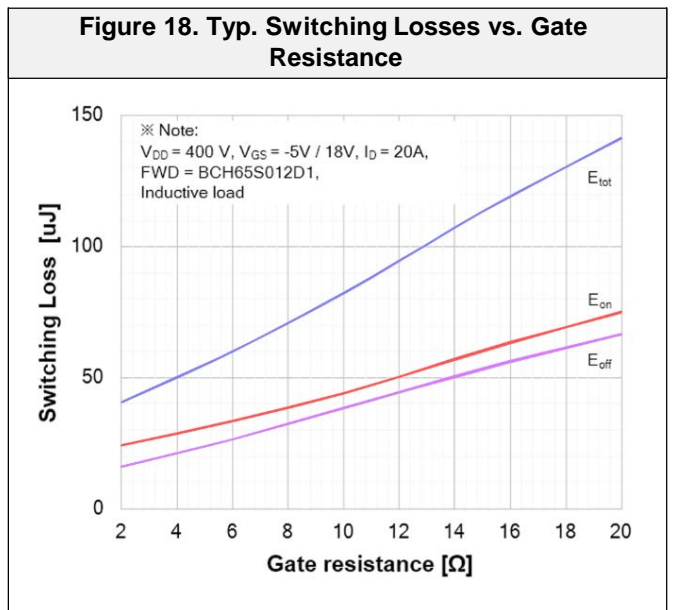
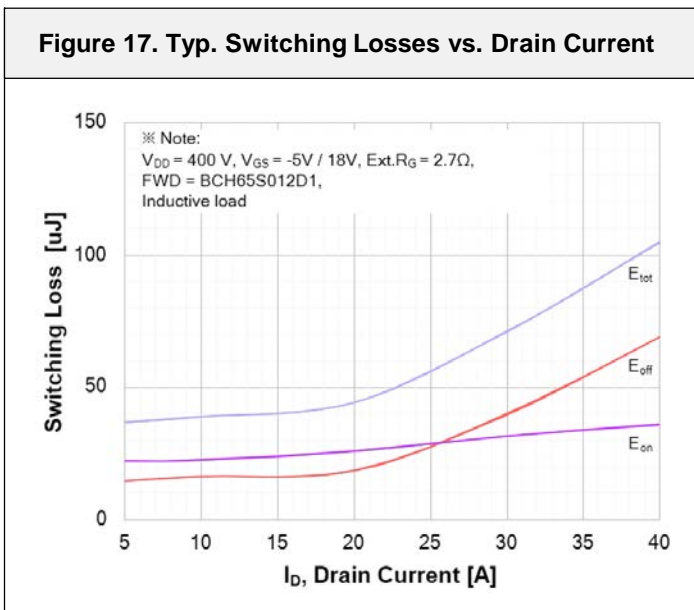
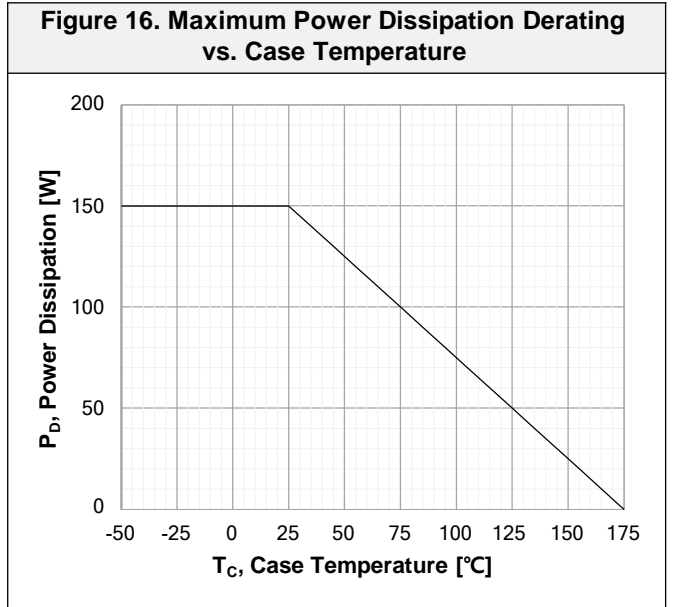
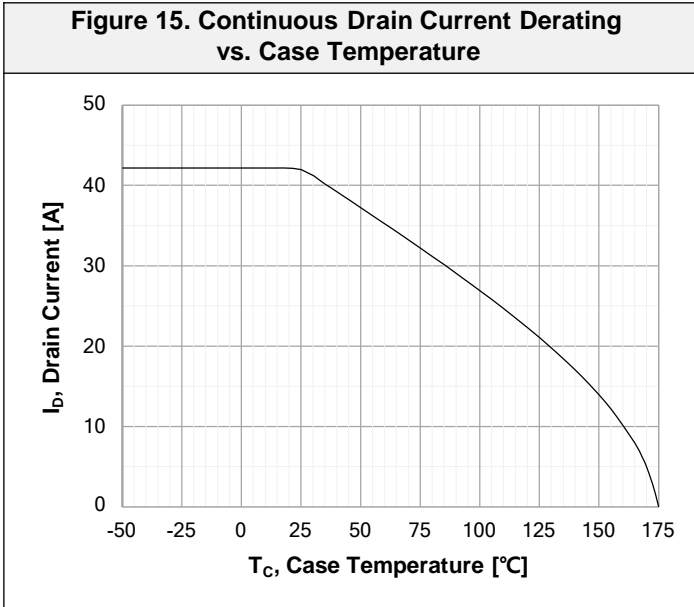
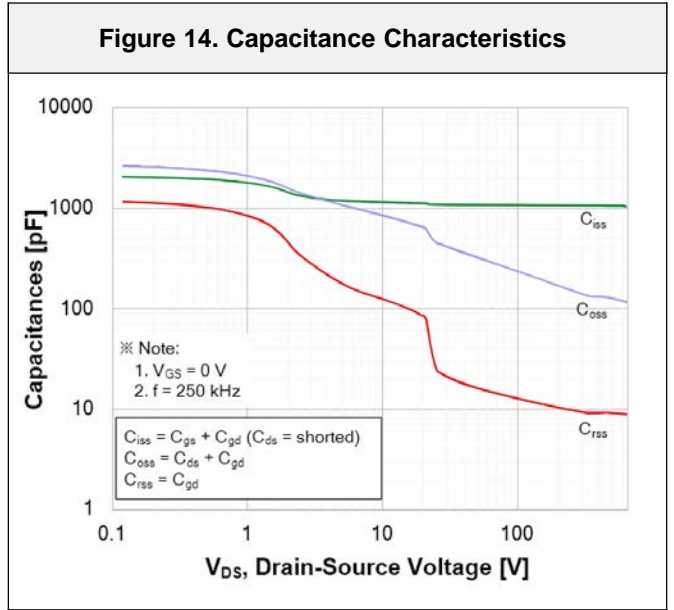
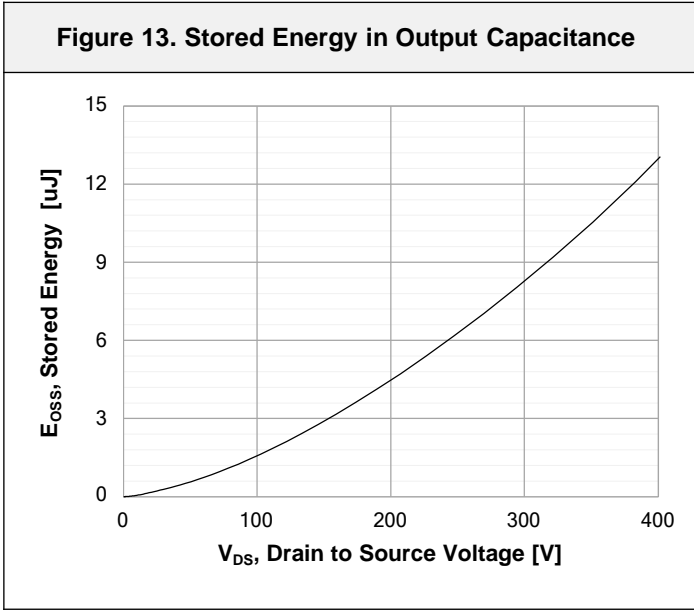

Typical Performance Characteristics

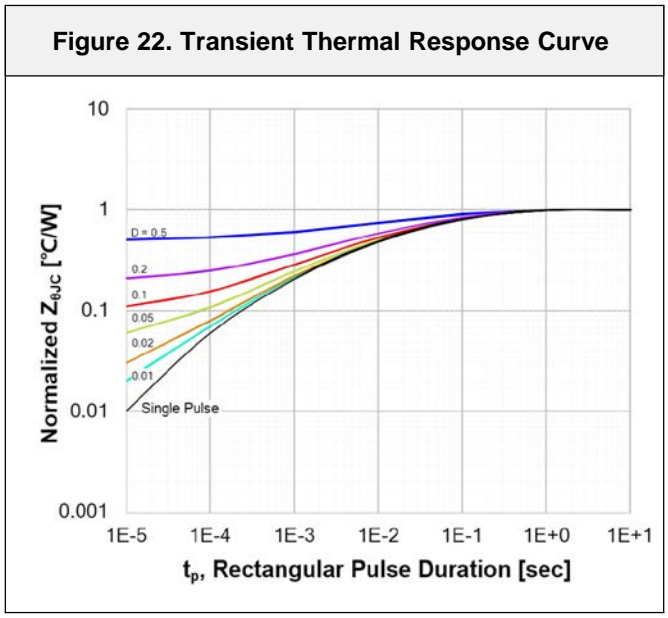
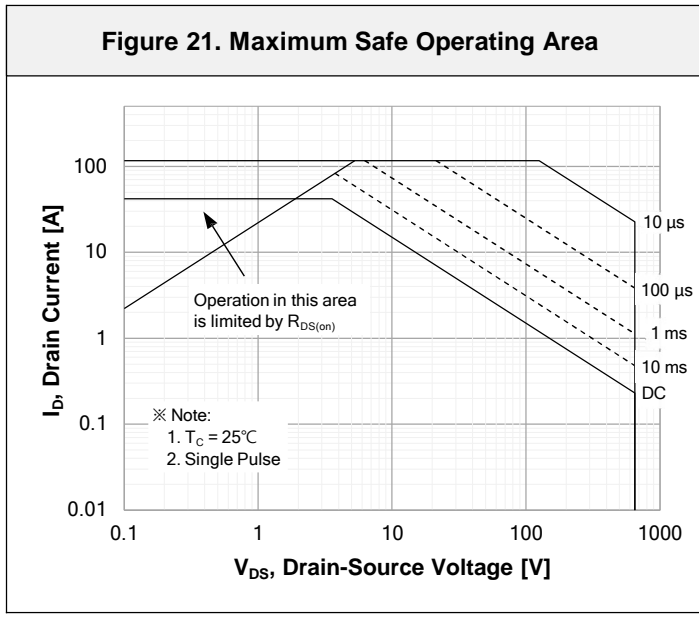
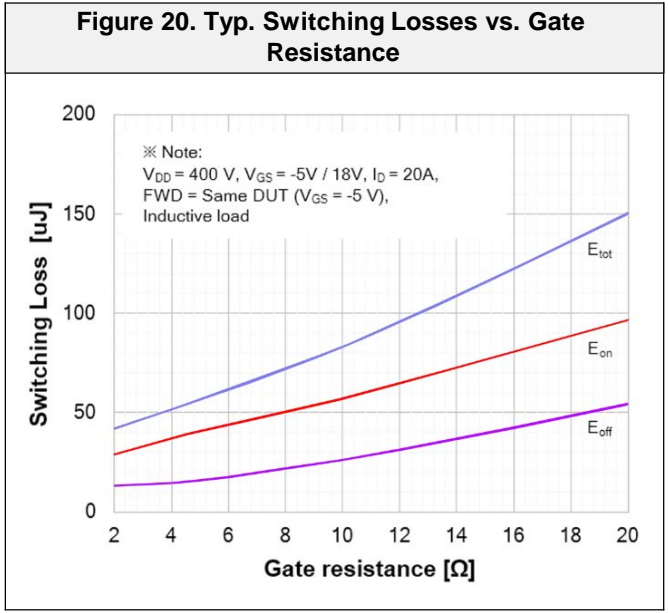
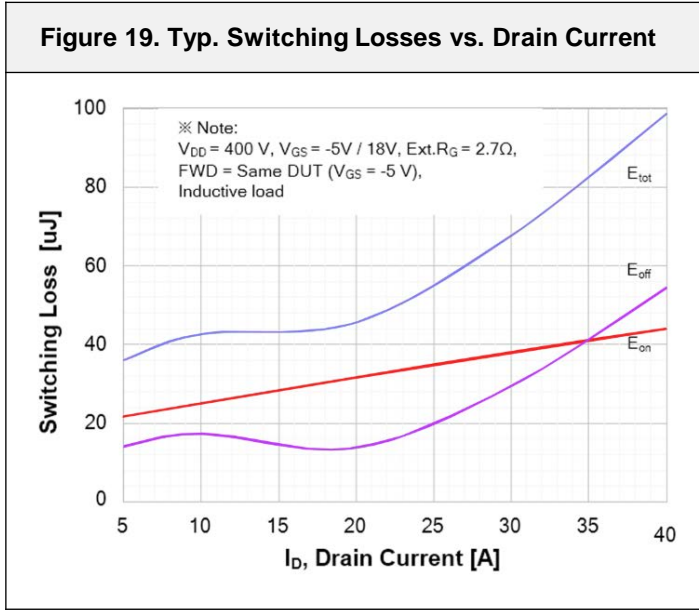

Typical Performance Characteristics

Figure 21. Inductive Load Switching Test Circuit and Waveforms

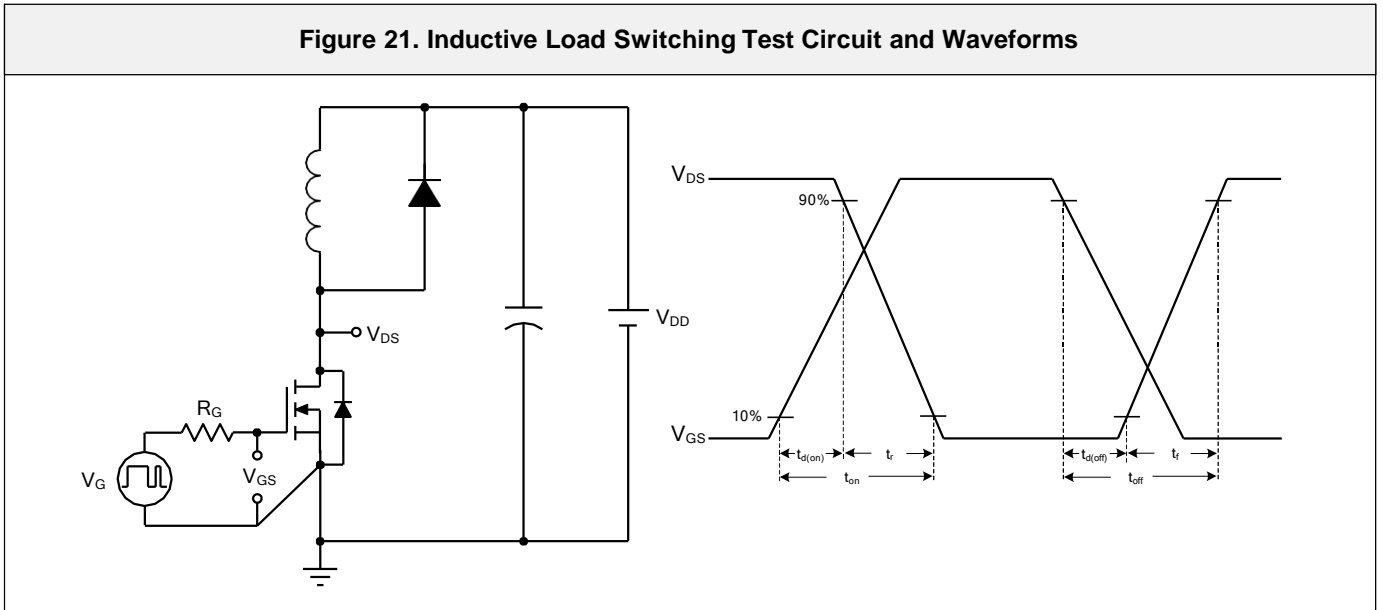
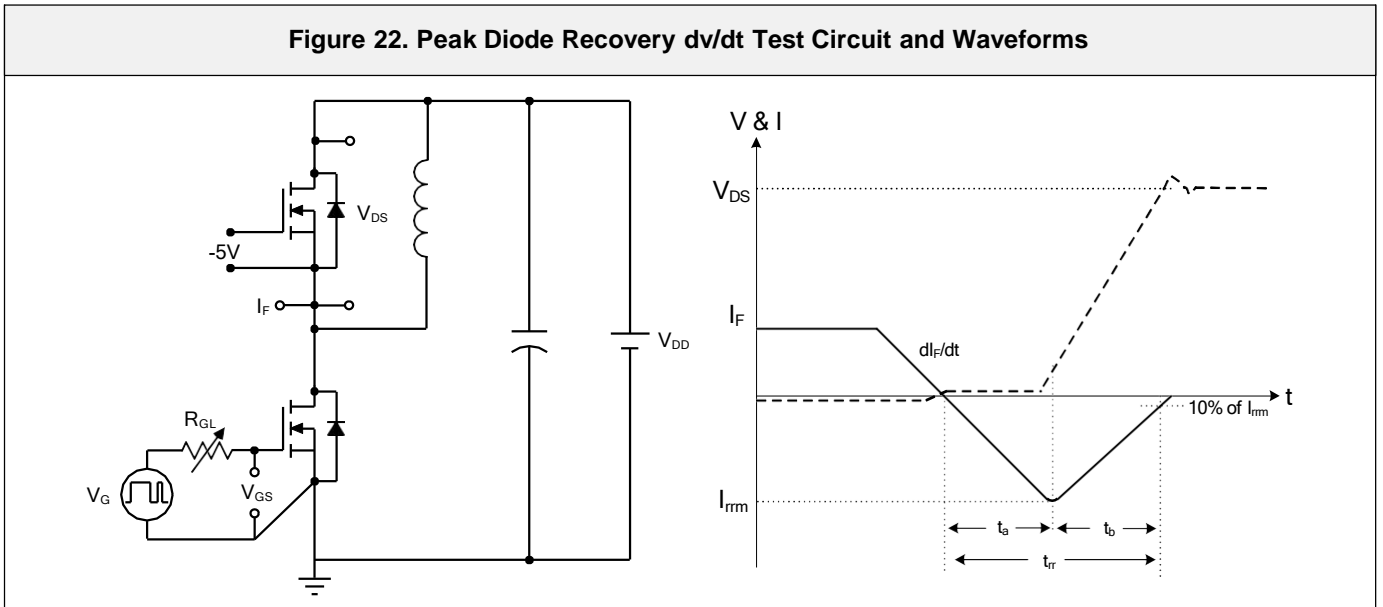
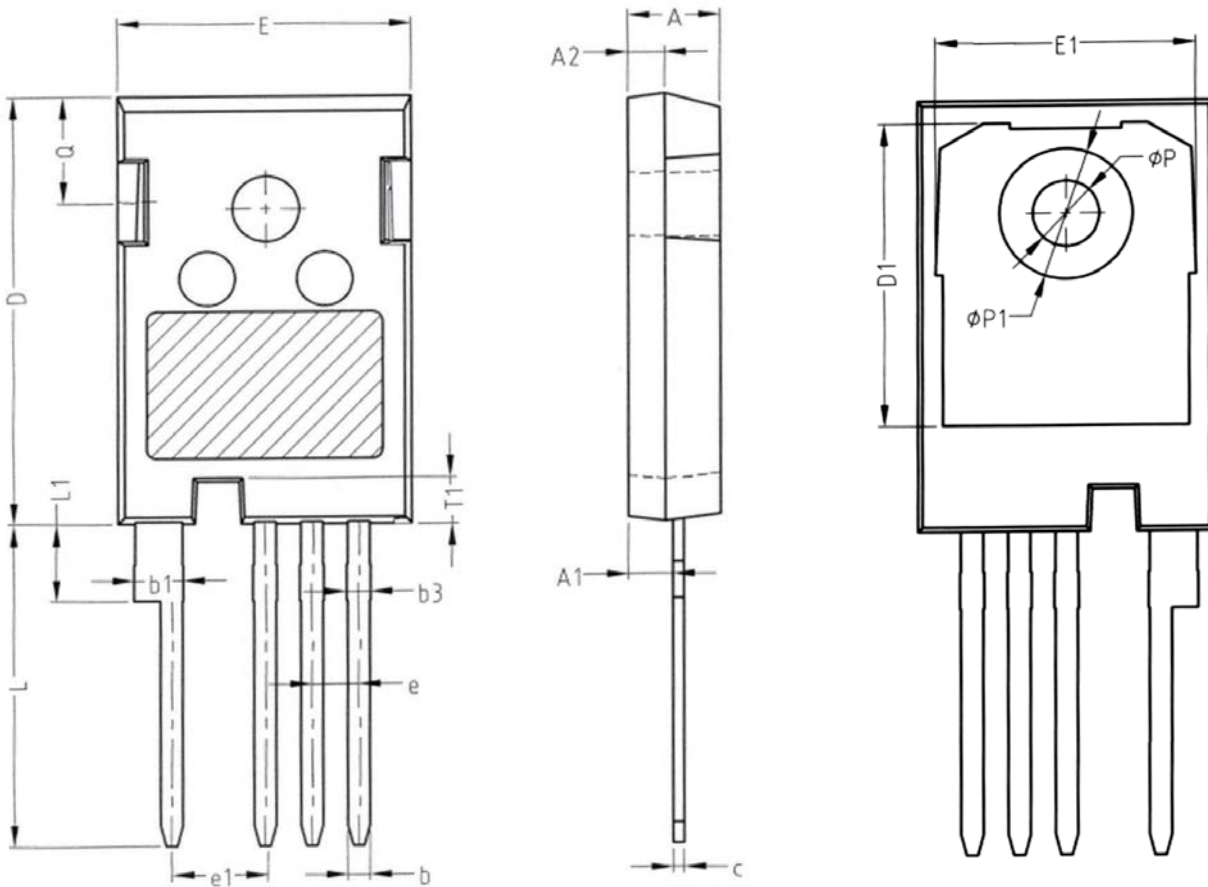

Figure 22. Peak Diode Recovery dv/dt Test Circuit and Waveforms



Package Outlines

TO247-4



SYMBOL	NM		
	MIN	NOM	MAX
A	4.80	5.00	5.20
A1	2.21	2.41	2.61
A2	1.80	2.00	2.20
b	1.06	1.21	1.36
b1	2.33	2.63	2.93
b3	1.07	1.30	1.60
c	0.51	0.61	0.75
D	23.30	23.45	23.60
D1	16.25	16.55	16.85
E	15.74	15.94	16.14
E1	13.72	14.02	14.32
T1	2.35	2.50	2.65
e	2.54 BSC		
e1	5.08 BSC		
Q	5.49	5.79	6.09
L	17.27	17.57	17.87
L1	3.99	4.19	4.39
Φp	3.40	3.60	3.80
$\Phi p1$	7.19 REF		

* Dimensions in millimeters

Package Marking and Ordering Information

Part Number	Top Marking	Package	Packing Method	Quantity
BCZ65N45M1	BCZ65N45M1	TO-247-4L	Tube	30 units

Disclaimer

Bestirpower reserve the right to make changes, corrections, enhancements, modifications, and improvements to Bestirpower products and/or to this document at any time without notice.

The information given in this document shall in no event be regarded as a guarantee of conditions or characteristics. Bestirpower does not assume any liability for infringement of patents, copyrights, or other intellectual property rights of third parties by or arising from the use of Products or technical information described in this document.

This document is the property of Bestirpower Co., LTD., and not allowed to copy or transformed to other format if not under the authority approval.

© 2023 Bestirpower – All rights reserved