

Infrared Assemblies

Dual Channel Transmissive Sensor

HOA1889 Series

FEATURES

- Choice of phototransistor or photodarlington output
- PCB mount package
- Polarized locator pins
- Accurate position sensing
- 0,5 mm (0.020 in.) aperture windows
- 1,78 mm (0.070 in.) slot width
- Available in shipping tubes



The HOA1889 Series consists of two infrared emitting diodes facing two NPN silicon phototransistors (HOA1889-011) or two photodarlington transistors (HOA1889-013) encased in a black thermoplastic housing. Detector switching takes place whenever an opaque object passes through the slot between the the emitter and the detector. The dual channels allow both the speed and the direction of the interrupter to be sensed. Emitters and detectors have a 0,5 mm (0.020 in.) vertical aperture. This feature is ideal for use in applications in which high position resolution is desired.

The sensor housing is an opaque thermoplastic with aperture openings for use in applications in which maximum rejection of ambient light is important and maximum position resolution is desired. The HOA1889 Series contains plastic molded components. For additional component information see SEP8506, SDP8406, and SDP8106.

Housing material is Valox®. Housings are soluble in chlorinated hydrocarbons and ketones. Recommended cleaning agents are methanol and isopropanol.

Valox is a registered trademark of General Electric Company.

Infrared Assemblies

Dual Channel Transmissive Sensor

HOA1889 Series

ABSOLUTE MAXIMUM RATINGS (25°C free-air temperature unless otherwise noted)

Operating Temperature Range	-40°C to 85°C
Storage Temperature Range	-40°C to 85°C
Soldering Temperature (5 sec)	240°C

IR EMITTER

Power Dissipation	100 mW ⁽¹⁾
Reverse Voltage	3 V
Continuous Forward Current	50 mA

DETECTOR	TRANSISTOR	DARLINGTON
Collector-Emitter Voltage	30 V	15 V
Emitter Collector Voltage	5 V	5 V
Power Dissipation	100 mW ⁽¹⁾	100 mW ⁽¹⁾
Collector DC Current	30 mA	30 mA

Note:

- Derate linearly at 0.78 mW/°C above 25°C.

CAUTION

STRESS DAMAGE

Functional operation of the device at or above "Absolute Maximum Ratings" for extended periods of time may affect reliability.

Failure to comply with these instructions may result in product damage.

ELECTRICAL CHARACTERISTICS (25°C unless otherwise noted)

Parameter	Symbol	Min	Typ	Max	Unit	Test Condition
IR EMITTER (each)						
Forward Voltage	V_F			1.6	V	$I_F=20$ mA
Reverse Leakage Current	I_R			10	μA	$V_R=3$ V
DETECTOR (each)						
Collector-Emitter Breakdown Voltage	$V_{(BR)CEO}$				V	$I_C=100$ μA
HOA1889-011		30				
HOA1889-013		15				
Emitter-Collector Breakdown Voltage	$V_{(BR)ECO}$	5.0			V	$I_E=100$ μA
Collector Dark Current	I_{CEO}				nA	$V_{CE}=10$ V $I_F=0$
HOA1889-011				100		
HOA1889-013				250		
COUPLED CHARACTERISTICS						
On-State Collector Current	$I_{C(ON)}$				mA	$V_{CE}=5$ V $I_F=20$ mA
HOA1889-011		0.5				
HOA1889-013		2.0				
Collector-Emitter Saturation Voltage	$V_{CE(SAT)}$				V	$I_F=20$ mA $I_C=40$ μA $I_C=250$ μA
HOA1889-011				0.4		
HOA1889-013				1.1		
Rise And Fall Time	t_r, t_f				μs	$V_{CC}=5$ V, $I_C=1$ mA $R_L=1000$ Ω $R_L=100$ Ω
HOA1889-011,			15			
HOA1889-013			75			

Infrared Assemblies

Dual Channel Transmissive Sensor

HOA1889 Series

SCHEMATIC

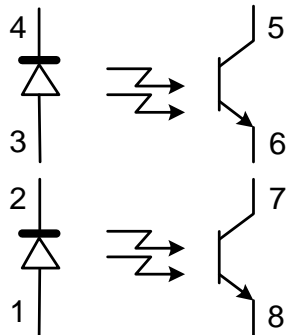

Figure 1: IRED Forward Bias Characteristics

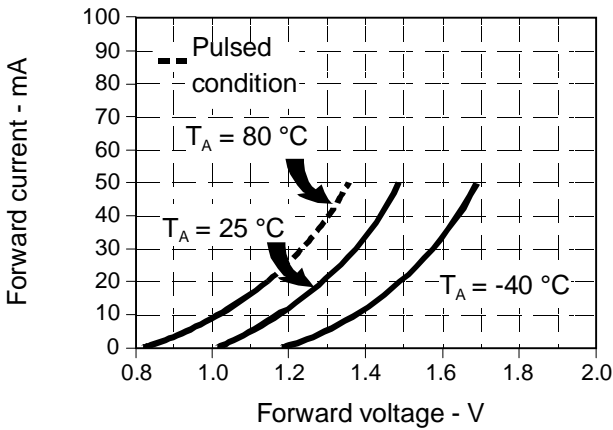

Figure 3: Detector Dark Current vs Temperature

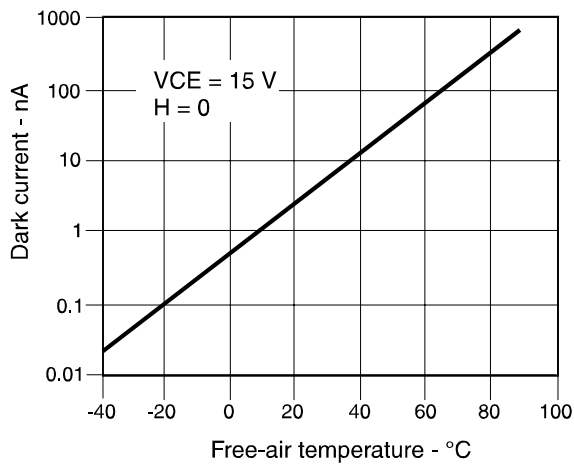

Figure 2: Non-saturated Switching Time vs Load Resistance

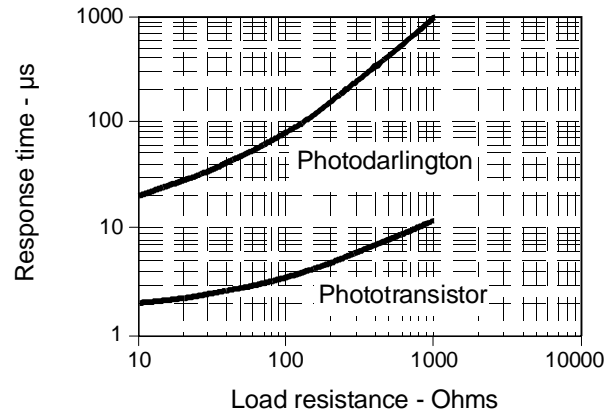
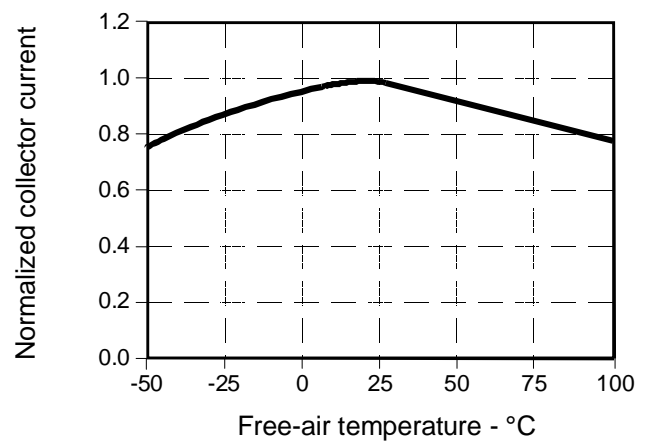

Figure 4: Collector Current vs Ambient Temperature



Infrared Assemblies

Dual Channel Transmissive Sensor

HOA1889 Series

ORDER GUIDE

Catalog Listing	Description
HOA1889-011	Dual Channel Transmissive Sensor, Phototransistor
HOA1889-013	Dual Channel Transmissive Sensor, Photodarlington

OUTLINE DIMENSIONS mm/(in.) (for reference only)

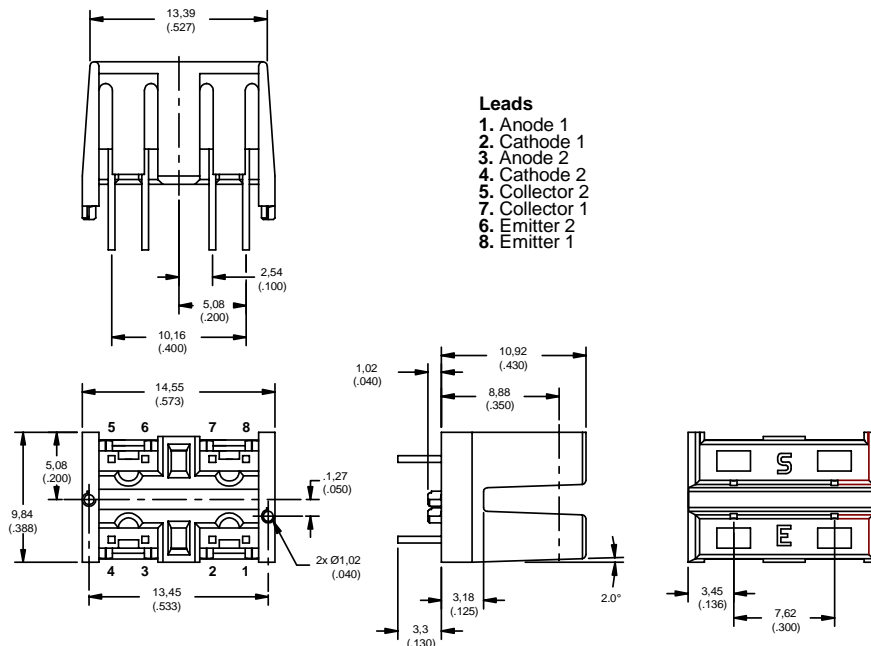

WARRANTY/REMEDY

Honeywell warrants goods of its manufacture as being free of defective material and faulty workmanship. Contact your local sales office for warranty information. If warranted goods are returned to Honeywell during that period of coverage, Honeywell will repair or replace without charge those items it finds defective. The foregoing is Buyer's sole remedy and is **in lieu of all other warranties, expressed or implied, including those of merchantability and fitness for a particular purpose.**

While we provide application assistance, personally, through our literature, and through the Honeywell website, it is up to the customer to determine the suitability of the product in the application.

Specifications may change at any time without notice. The information we supply is believed to be accurate and reliable as of this printing. However, we assume no responsibility for its use.

SALES AND SERVICE

MICRO SWITCH Sensing and Control serves its customers through a worldwide network of sales offices and distributors. For application assistance, current specifications, pricing or name of the nearest Authorized Distributor, contact a nearby sales office or call:

TELEPHONE

1-800-537-6945 (USA)
1-800-737-3360 (Canada)
1-815-235-6847 (International)

FAX

1-815-235-6545 (USA)

INTERNET

www.honeywell.com/sensing
info@micro.honeywell.com

Honeywell

Sensing and Control
Honeywell Inc.
11 West Spring Street
Freeport, Illinois 61032

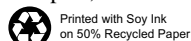

006457-1-EN IL50 GLO 1298 Printed in USA

www.honeywell.com/sensing