

Thyristor \ Diode Module

$$V_{RRM} = 2 \times 1800 \text{ V}$$

$$I_{TAV} = 320 \text{ A}$$

$$V_T = 1.06 \text{ V}$$

Phase leg

Part number

MCD312-18io1

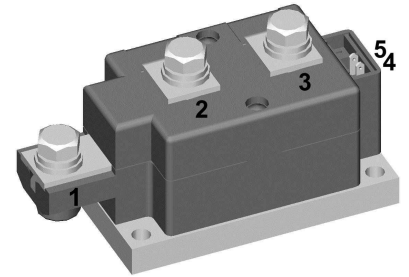

Backside: isolated

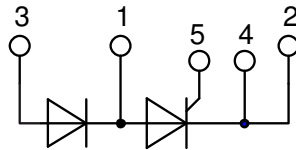
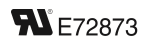

Features / Advantages:

- International standard package
- Direct copper bonded Al₂O₃-ceramic with copper base plate
- Planar passivated chip
- Isolation voltage 3600 V~
- Keyed gate/cathode twin pins

Applications:

- Motor control, softstarter
- Power converter
- Heat and temperature control for industrial furnaces and chemical processes
- Lighting control
- Solid state switches

Package: Y1

- Isolation Voltage: 3600 V~
- Industry standard outline
- RoHS compliant
- Base plate: Copper internally DCB isolated
- Advanced power cycling

Terms .Conditions of usage:

The data contained in this product data sheet is exclusively intended for technically trained staff. The user will have to evaluate the suitability of the product for the intended application and the completeness of the product data with respect to his application. The specifications of our components may not be considered as an assurance of component characteristics. The information in the valid application- and assembly notes must be considered. Should you require product information in excess of the data given in this product data sheet or which concerns the specific application of your product, please contact the sales office, which is responsible for you.

Due to technical requirements our product may contain dangerous substances. For information on the types in question please contact the sales office, which is responsible for you.

Should you intend to use the product in aviation, in health or live endangering or life support applications, please notify. For any such application we urgently recommend

- to perform joint risk and quality assessments;

- the conclusion of quality agreements;

- to establish joint measures of an ongoing product survey, and that we may make delivery dependent on the realization of any such measures.

Rectifier			Ratings			
Symbol	Definition	Conditions	min.	typ.	max.	Unit
$V_{RSM/DSM}$	max. non-repetitive reverse/forward blocking voltage	$T_{VJ} = 25^{\circ}C$			1900	V
$V_{RRM/DRM}$	max. repetitive reverse/forward blocking voltage	$T_{VJ} = 25^{\circ}C$			1800	V
I_{RD}	reverse current, drain current	$V_{R/D} = 1800 V$	$T_{VJ} = 25^{\circ}C$		1	mA
		$V_{R/D} = 1800 V$	$T_{VJ} = 140^{\circ}C$		40	mA
V_T	forward voltage drop	$I_T = 300 A$	$T_{VJ} = 25^{\circ}C$		1.12	V
		$I_T = 600 A$			1.32	V
		$I_T = 300 A$	$T_{VJ} = 125^{\circ}C$		1.06	V
		$I_T = 600 A$			1.29	V
I_{TAV}	average forward current	$T_C = 85^{\circ}C$	$T_{VJ} = 140^{\circ}C$		320	A
$I_{T(RMS)}$	RMS forward current	180° sine			520	A
V_{T0}	threshold voltage	} for power loss calculation only	$T_{VJ} = 140^{\circ}C$		0.80	V
r_T	slope resistance				0.68	mΩ
R_{thJC}	thermal resistance junction to case				0.12	K/W
R_{thCH}	thermal resistance case to heatsink			0.04		K/W
P_{tot}	total power dissipation		$T_C = 25^{\circ}C$		960	W
I_{TSM}	max. forward surge current	$t = 10 \text{ ms}; (50 \text{ Hz}), \text{ sine}$	$T_{VJ} = 45^{\circ}C$		9.60	kA
		$t = 8,3 \text{ ms}; (60 \text{ Hz}), \text{ sine}$	$V_R = 0 V$		10.4	kA
		$t = 10 \text{ ms}; (50 \text{ Hz}), \text{ sine}$	$T_{VJ} = 140^{\circ}C$		8.16	kA
		$t = 8,3 \text{ ms}; (60 \text{ Hz}), \text{ sine}$	$V_R = 0 V$		8.82	kA
I^2t	value for fusing	$t = 10 \text{ ms}; (50 \text{ Hz}), \text{ sine}$	$T_{VJ} = 45^{\circ}C$		460.8	kA ² s
		$t = 8,3 \text{ ms}; (60 \text{ Hz}), \text{ sine}$	$V_R = 0 V$		447.4	kA ² s
		$t = 10 \text{ ms}; (50 \text{ Hz}), \text{ sine}$	$T_{VJ} = 140^{\circ}C$		332.9	kA ² s
		$t = 8,3 \text{ ms}; (60 \text{ Hz}), \text{ sine}$	$V_R = 0 V$		323.3	kA ² s
C_J	junction capacitance	$V_R = 400 V \quad f = 1 \text{ MHz}$	$T_{VJ} = 25^{\circ}C$		438	pF
P_{GM}	max. gate power dissipation	$t_p = 30 \mu s$	$T_C = 140^{\circ}C$		120	W
		$t_p = 500 \mu s$			60	W
P_{GAV}	average gate power dissipation				20	W
$(di/dt)_{cr}$	critical rate of rise of current	$T_{VJ} = 140^{\circ}C; f = 50 \text{ Hz}$	repetitive, $I_T = 960 A$		100	A/μs
		$t_p = 200 \mu s; di_G/dt = 1 A/\mu s;$	non-repet., $I_T = 320 A$		500	A/μs
$(dv/dt)_{cr}$	critical rate of rise of voltage	$V = \frac{2}{3} V_{DRM}$	$T_{VJ} = 140^{\circ}C$		1000	V/μs
		$R_{GK} = \infty; \text{method 1 (linear voltage rise)}$				
V_{GT}	gate trigger voltage	$V_D = 6 V$	$T_{VJ} = 25^{\circ}C$		2	V
			$T_{VJ} = -40^{\circ}C$		3	V
I_{GT}	gate trigger current	$V_D = 6 V$	$T_{VJ} = 25^{\circ}C$		150	mA
			$T_{VJ} = -40^{\circ}C$		220	mA
V_{GD}	gate non-trigger voltage	$V_D = \frac{2}{3} V_{DRM}$	$T_{VJ} = 140^{\circ}C$		0.25	V
I_{GD}	gate non-trigger current				10	mA
I_L	latching current	$t_p = 30 \mu s$	$T_{VJ} = 25^{\circ}C$		200	mA
		$I_G = 0.45 A; di_G/dt = 0.45 A/\mu s$				
I_H	holding current	$V_D = 6 V \quad R_{GK} = \infty$	$T_{VJ} = 25^{\circ}C$		150	mA
t_{gd}	gate controlled delay time	$V_D = \frac{1}{2} V_{DRM}$	$T_{VJ} = 25^{\circ}C$		2	μs
		$I_G = 1 A; di_G/dt = 1 A/\mu s$				
t_q	turn-off time	$V_R = 100 V; I_T = 300 A; V = \frac{2}{3} V_{DRM}$	$T_{VJ} = 125^{\circ}C$		200	μs
		$di/dt = 10 A/\mu s \quad dv/dt = 50 V/\mu s \quad t_p = 200 \mu s$				

Package Y1				Ratings		
Symbol	Definition	Conditions	min.	typ.	max.	Unit
I_{RMS}	RMS current	per terminal			600	A
T_{VJ}	virtual junction temperature		-40		140	°C
T_{op}	operation temperature		-40		125	°C
T_{stg}	storage temperature		-40		125	°C
Weight				680		g
M_D	mounting torque		4.5		7	Nm
M_T	terminal torque		11		13	Nm
$d_{Spp/App}$	creepage distance on surface striking distance through air	terminal to terminal	16.0			mm
$d_{Spb/Apb}$		terminal to backside	16.0			mm
V_{ISOL}	isolation voltage	t = 1 second	3600			V
		t = 1 minute	3000			V

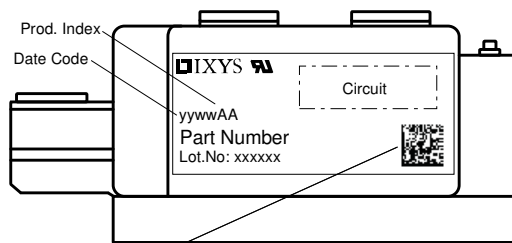

Data Matrix: Typ (1-19), DC+Prod.Index (20-25), FKT# (26-31)
leer (33), lfd.# (33-36)

Ordering	Ordering Number	Marking on Product	Delivery Mode	Quantity	Code No.
Standard	MCD312-18io1	MCD312-18io1	Box	3	461865

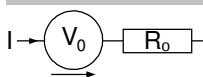
Equivalent Circuits for Simulation
** on die level*
 $T_{VJ} = 140\text{ °C}$

Thyristor

$V_{0\ max}$	threshold voltage	0.8	V
$R_{0\ max}$	slope resistance *	0.5	mΩ

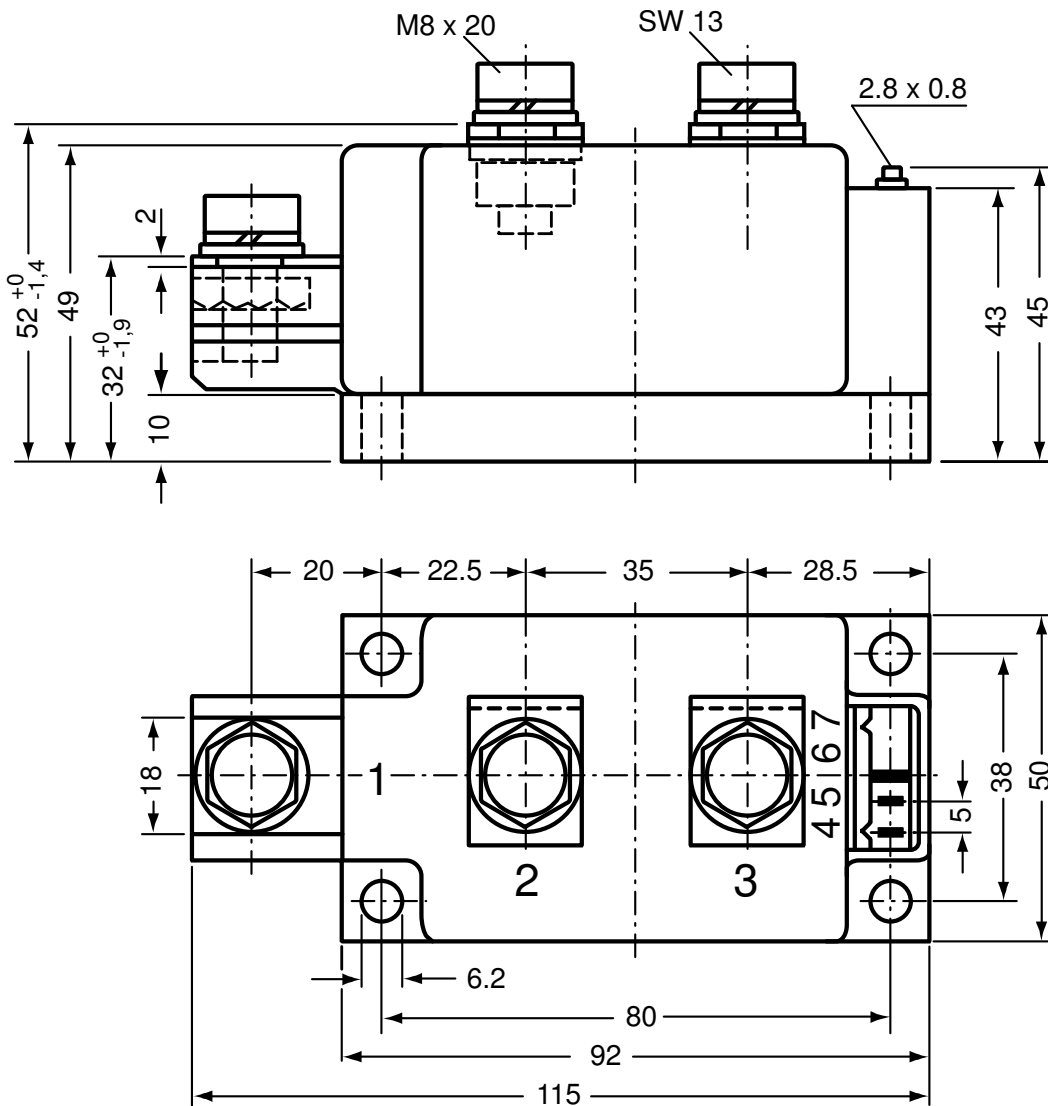
Outlines Y1



Optional accessories for modules

Keyed gate/cathode twin plugs with wire length = 350 mm, gate = white, cathode = red

Type ZY 180L (L = Left for pin pair 4/5) } UL 758, style 3751
 Type ZY 180R (R = Right for pin pair 6/7)

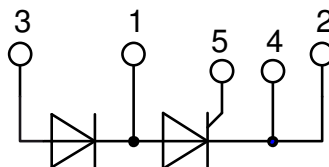

Thyristor

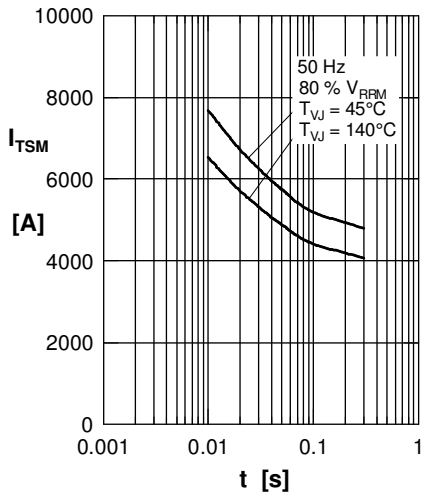

Fig. 1 Surge overload current
 I_{TSM} : Crest value, t : duration

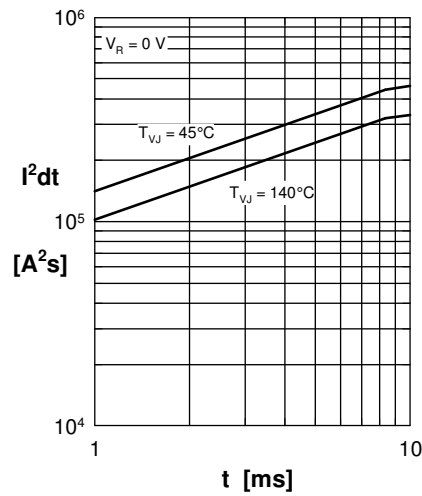

Fig. 2 I^2dt versus time

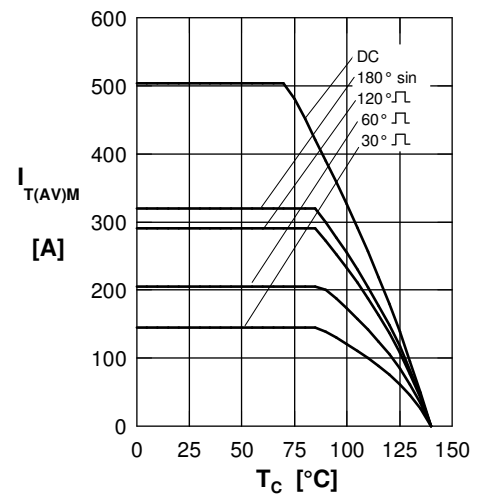

Fig. 3 Max. forward current at case temperature

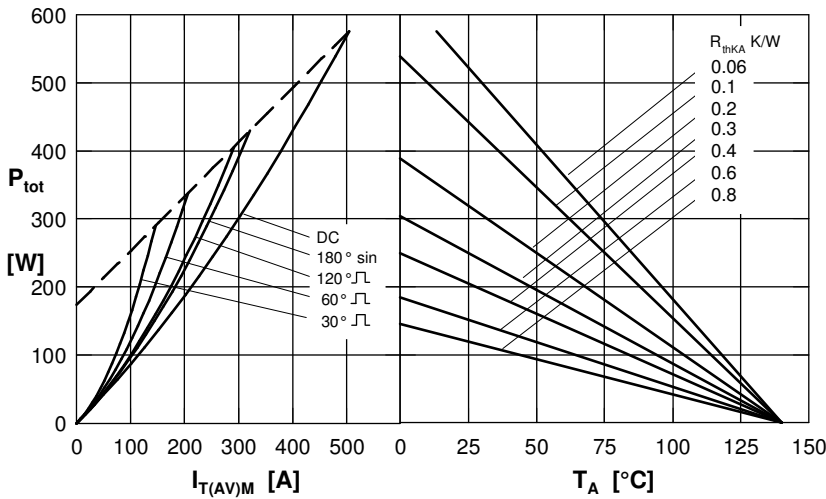

Fig. 4 Power dissipation versus on-state current and ambient temperature (per thyristor)

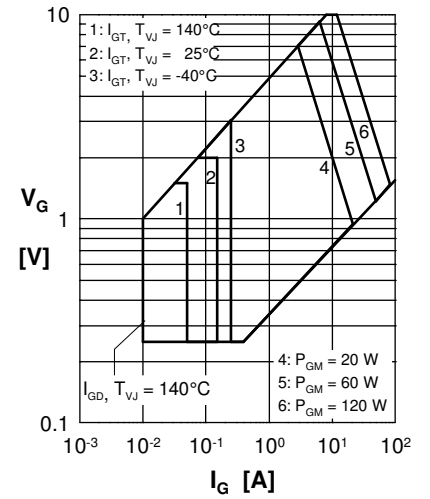

Fig. 5 Gate voltage & gate current

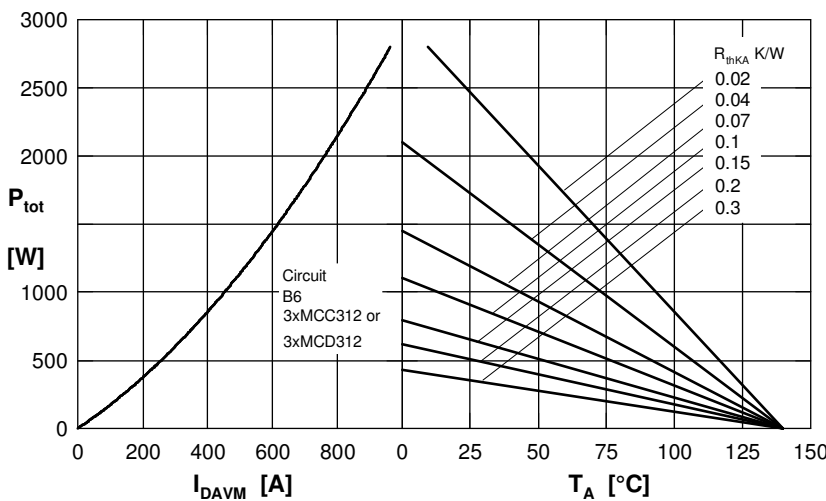

Fig. 6 Three phase rectifier bridge: Power dissipation versus direct output current and ambient temperature

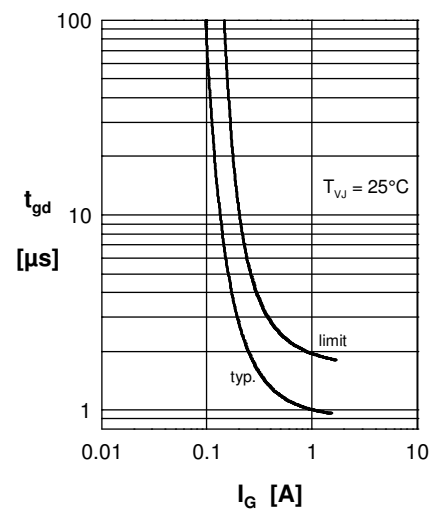

Fig. 7 Gate controlled delay time t_{gd}

Rectifier

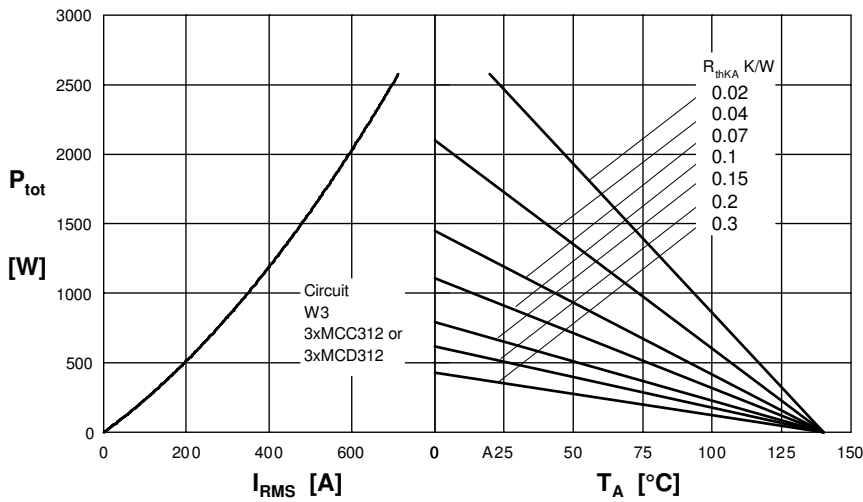

Fig. 8 Three phase AC-controller: Power dissipation versus R_{MS} output current and ambient temperature

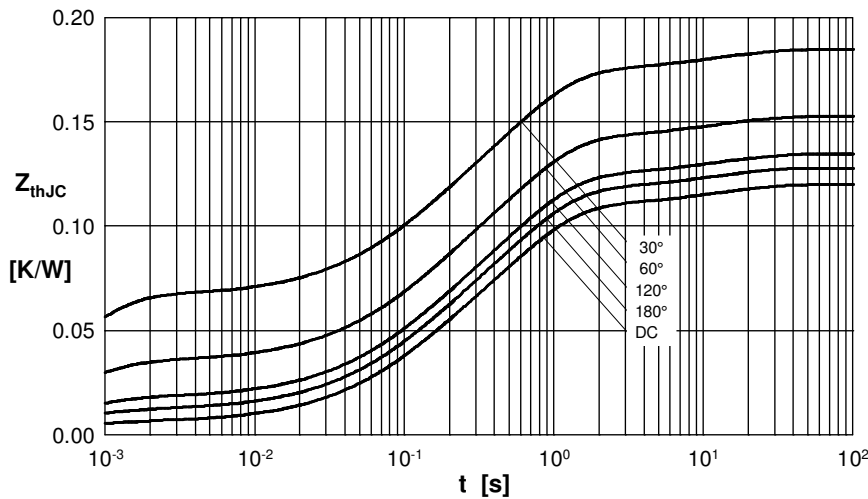

Fig. 9 Transient thermal impedance junction to case (per thyristor)

R_{thJC} for various conduct. angles d:

d	R_{thJC} [K/W]
DC	0.120
180°	0.128
120°	0.135
60°	0.153
30°	0.185

Constants for Z_{thJC} calculation:

i	R_{thi} [K/W]	t_i [s]
1	0.0058	0.00054
2	0.0310	0.098
3	0.0720	0.54
4	0.0112	12

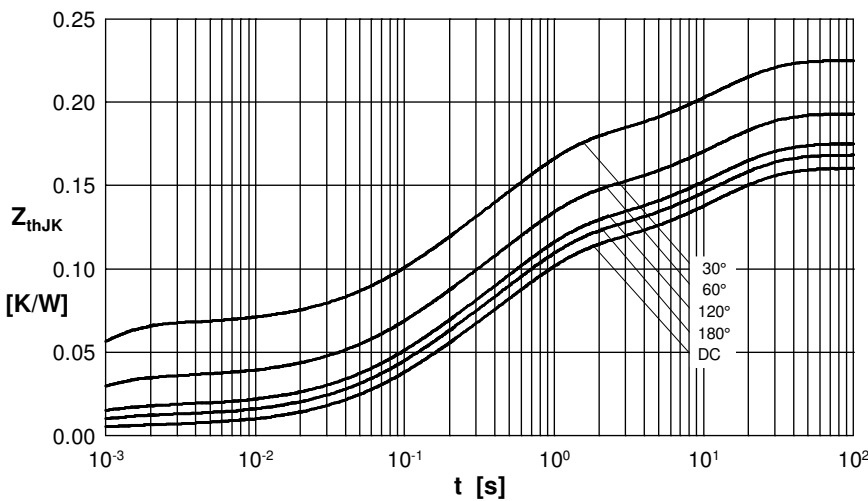

Fig. 10 Transient thermal impedance junction to heatsink (per thyristor)

R_{thJK} for various conduct. angles d:

d	R_{thJK} [K/W]
DC	0.160
180°	0.168
120°	0.175
60°	0.193
30°	0.225

Constants for Z_{thJK} calculation:

i	R_{thi} [K/W]	t_i [s]
1	0.0058	0.00054
2	0.0310	0.098
3	0.0720	0.54
4	0.0114	12
5	0.0400	12