

Printed-circuit board connector - MCV 1,5/ 3-GF-3,81 - 1830606

Please be informed that the data shown in this PDF Document is generated from our Online Catalog. Please find the complete data in the user's documentation. Our General Terms of Use for Downloads are valid (<http://phoenixcontact.com/download>)

PCB headers, nominal current: 8 A, rated voltage (III/2): 160 V, number of positions: 3, pitch: 3.81 mm, color: green, contact surface: Tin, mounting: Wave soldering



The figure shows a 10-position version of the product

Your advantages

- ✓ Well-known mounting principle allows worldwide use
- ✓ Screwable flange for superior mechanical stability
- ✓ Vertical connection enables multi-row arrangement on the PCB
- ✓ Maximum flexibility when it comes to device design – one header for connectors with different connection technologies

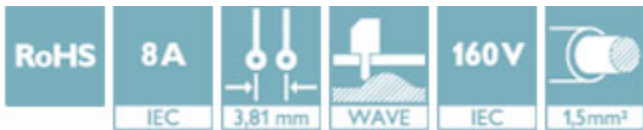

Key Commercial Data

Packing unit	1 pc
GTIN	
GTIN	4017918051259
Weight per Piece (excluding packing)	2.100 g
Custom tariff number	85366930
Country of origin	Germany

Technical data

Dimensions

Length [l]	7.25 mm
Width	21.82 mm
Pitch	3.81 mm
Dimension a	7.62 mm
Width [w]	21.82 mm

Printed-circuit board connector - MCV 1,5/ 3-GF-3,81 - 1830606

Technical data

Dimensions

Height [h]	12.6 mm
Height	9.2 mm
Length of the solder pin	3.4 mm
Pin dimensions	0.8 x 0.8 mm
Length	7.25 mm

General

Range of articles	MCV 1,5/...-GF
Insulating material group	IIIa
Rated surge voltage (III/3)	2.5 kV
Rated surge voltage (III/2)	2.5 kV
Rated surge voltage (II/2)	2.5 kV
Rated voltage (III/3)	160 V
Rated voltage (III/2)	160 V
Rated voltage (II/2)	250 V
Connection in acc. with standard	EN-VDE
Nominal current I _N	8 A
Maximum load current	8 A
Insulating material	PBT
Flammability rating according to UL 94	V0
Color	green
Number of positions	3

Standards and Regulations

Connection in acc. with standard	EN-VDE
	CSA
Flammability rating according to UL 94	V0

Environmental Product Compliance

REACH SVHC	Lead 7439-92-1
China RoHS	Environmentally Friendly Use Period = 50
	For details about hazardous substances go to tab "Downloads", Category "Manufacturer's declaration"

Drawings

Printed-circuit board connector - MCV 1,5/ 3-GF-3,81 - 1830606

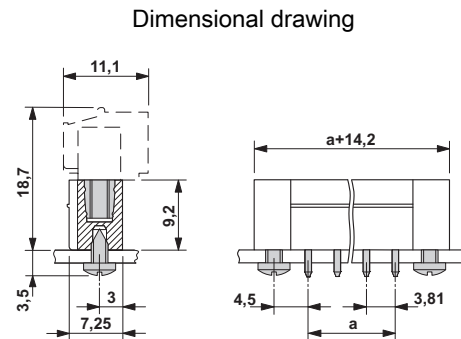
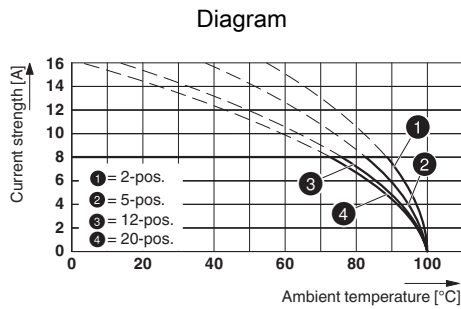

Type: MC 1,5/...-STF-3,81 with MCV 1,5/...-GF-3,81

Classifications

eCl@ss

eCl@ss 4.0	272607xx
eCl@ss 4.1	27260701
eCl@ss 5.0	27260701
eCl@ss 5.1	27260700
eCl@ss 6.0	27260700
eCl@ss 7.0	27440402
eCl@ss 8.0	27440402
eCl@ss 9.0	27440402

ETIM

ETIM 3.0	EC001121
ETIM 4.0	EC002637
ETIM 5.0	EC002637
ETIM 6.0	EC002637

UNSPSC

UNSPSC 6.01	30211810
UNSPSC 7.0901	39121409
UNSPSC 11	39121409
UNSPSC 12.01	39121409
UNSPSC 13.2	39121409

Approvals

Approvals

Printed-circuit board connector - MCV 1,5/ 3-GF-3,81 - 1830606

Approvals

Approvals

CSA / VDE Gutachten mit Fertigungsüberwachung / IECEE CB Scheme / cULus Recognized / EAC

Ex Approvals

Approval details

CSA		http://www.csagroup.org/services-industries/product-listing/	13631
	D	B	
Nominal voltage UN	300 V	300 V	
Nominal current IN	8 A	8 A	

VDE Gutachten mit Fertigungsüberwachung		http://www2.vde.com/de/Institut/Online-Service/VDE-gepruefteProdukte/Seiten/Online-Suche.aspx	40011723
Nominal voltage UN	160 V		
Nominal current IN	8 A		

IECEE CB Scheme		http://www.iecee.org/	DE1-60987-B1B2
Nominal voltage UN	160 V		
Nominal current IN	8 A		

cULus Recognized		http://database.ul.com/cgi-bin/XYV/template/LISEXT/1FRAME/index.htm	E60425-20110128
	D	B	
Nominal voltage UN	300 V	300 V	
Nominal current IN	8 A	8 A	

Printed-circuit board connector - MCV 1,5/ 3-GF-3,81 - 1830606

Approvals

EAC		B.01742
-----	---	---------

Accessories

Accessories

Coding element

Coding profile - CP-MSTB - 1734634

Coding profile, is inserted into the slot on the plug or inverted header, red insulating material



Labeled terminal marker

Marker card - SK 3,81/2,8:FORTL.ZAHLEN - 0804109



Marker card, Card, white, labeled, Horizontal: consecutive numbers 1 - 10, 11 - 20, etc. up to 91 - (99)100, mounting type: adhesive, for terminal block width: 3.81 mm, lettering field size: 3.81 x 2.8 mm

Additional products

Printed-circuit board connector - FMC 1,5/ 3-STF-3,81 - 1748367

PCB connector, nominal current: 8 A, rated voltage (III/2): 160 V, number of positions: 3, pitch: 3.81 mm, connection method: Push-in spring connection, color: green, contact surface: Tin



Printed-circuit board connector - MCV 1,5/ 3-GF-3,81 - 1830606

Accessories

Printed-circuit board connector - MC 1,5/ 3-STF-3,81 - 1827716

PCB connector, nominal current: 8 A, rated voltage (III/2): 160 V, number of positions: 3, pitch: 3.81 mm, connection method: Screw connection with tension sleeve, color: green, contact surface: Tin



Printed-circuit board connector - MCVR 1,5/ 3-STF-3,81 - 1828359

PCB connector, nominal current: 8 A, rated voltage (III/2): 160 V, number of positions: 3, pitch: 3.81 mm, connection method: Screw connection with tension sleeve, color: green, contact surface: Tin



Printed-circuit board connector - MCVW 1,5/ 3-STF-3,81 - 1828508

PCB connector, nominal current: 8 A, rated voltage (III/2): 160 V, number of positions: 3, pitch: 3.81 mm, connection method: Screw connection with tension sleeve, color: green, contact surface: Tin



Printed-circuit board connector - FRONT-MC 1,5/ 3-STF-3,81 - 1850864

PCB connector, nominal current: 8 A, rated voltage (III/2): 160 V, number of positions: 3, pitch: 3.81 mm, connection method: Front screw connection, color: green, contact surface: Tin



Printed-circuit board connector - FK-MCP 1,5/ 3-STF-3,81 - 1851245

PCB connector, nominal current: 8 A, rated voltage (III/2): 160 V, number of positions: 3, pitch: 3.81 mm, connection method: Push-in spring connection, color: green, contact surface: Tin

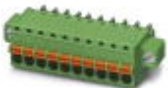

Printed-circuit board connector - MCV 1,5/ 3-GF-3,81 - 1830606

Accessories

Printed-circuit board connector - MCC 1/ 3-STZF-3,81 - 1852370

PCB connector, nominal current: 8 A, rated voltage (III/2): 160 V, number of positions: 3, pitch: 3.81 mm, connection method: Crimp connection, color: green, Corresponding female crimp contacts with current [A] and conductor cross section range [mm²] data: 5A/MCC-MT 0,2-0,35 (1859988); 8A/MCC-MT 0,5-1,0 (1859991)



Printed-circuit board connector - QC 0,5/ 3-STF-3,81 - 1897555

PCB connector, nominal current: 6 A, rated voltage (III/2): 200 V, number of positions: 3, pitch: 3.81 mm, connection method: Displacement connection, color: green, contact surface: Tin

