



THIS SPEC IS OBSOLETE

Spec No: 38-05339

Spec Title: CY62146DV30 MoBL(R) 4-Mbit (256K x 16) Static RAM

Sunset Owner: Anuj Chakrapani (AJU)

Replaced by: None

4-Mbit (256K x 16) Static RAM

Features

- **Very high speed: 45 ns**
- **Wide voltage range: 2.20V–3.60V**
- **Pin-compatible with CY62146CV30**
- **Ultra-low active power**
 - Typical active current: 1.5 mA @ f = 1 MHz
 - Typical active current: 8 mA @ f = f_{max}
- **Ultra low standby power**
- **Easy memory expansion with \overline{CE} , and \overline{OE} features**
- **Automatic power-down when deselected**
- **CMOS for optimum speed/power**
- **Packages offered 48-ball BGA and 44-pin TSOPII**
- **Also available in Lead-free packages**

Functional Description^[1]

The CY62146DV30 is a high-performance CMOS static RAM organized as 256K words by 16 bits. This device features advanced circuit design to provide ultra-low active current. This is ideal for providing More Battery Life™ (MoBL[®]) in portable applications such as cellular telephones. The device also has

an automatic power-down feature that significantly reduces power consumption. The device can also be put into standby mode reducing power consumption by more than 99% when deselected (CE HIGH). The input/output pins (I/O₀ through I/O₁₅) are placed in a high-impedance state when: deselected (CE HIGH), outputs are disabled (\overline{OE} HIGH), both Byte High Enable and Byte Low Enable are disabled (\overline{BHE} , BLE HIGH), or during a write operation (CE LOW and WE LOW).

Writing to the device is accomplished by taking Chip Enable (\overline{CE}) and Write Enable (WE) inputs LOW. If Byte Low Enable (BLE) is LOW, then data from I/O pins (I/O₀ through I/O₇), is written into the location specified on the address pins (A₀ through A₁₇). If Byte High Enable (BHE) is LOW, then data from I/O pins (I/O₈ through I/O₁₅) is written into the location specified on the address pins (A₀ through A₁₇).

Reading from the device is accomplished by taking Chip Enable (CE) and Output Enable (\overline{OE}) LOW while forcing the Write Enable (WE) HIGH. If Byte Low Enable (BLE) is LOW, then data from the memory location specified by the address pins will appear on I/O₀ to I/O₇. If Byte High Enable (BHE) is LOW, then data from memory will appear on I/O₈ to I/O₁₅. See the truth table at the back of this data sheet for a complete description of read and write modes.

The CY62146DV30 is available in a 48-ball VFBGA, 44-pin TSOPII packages.

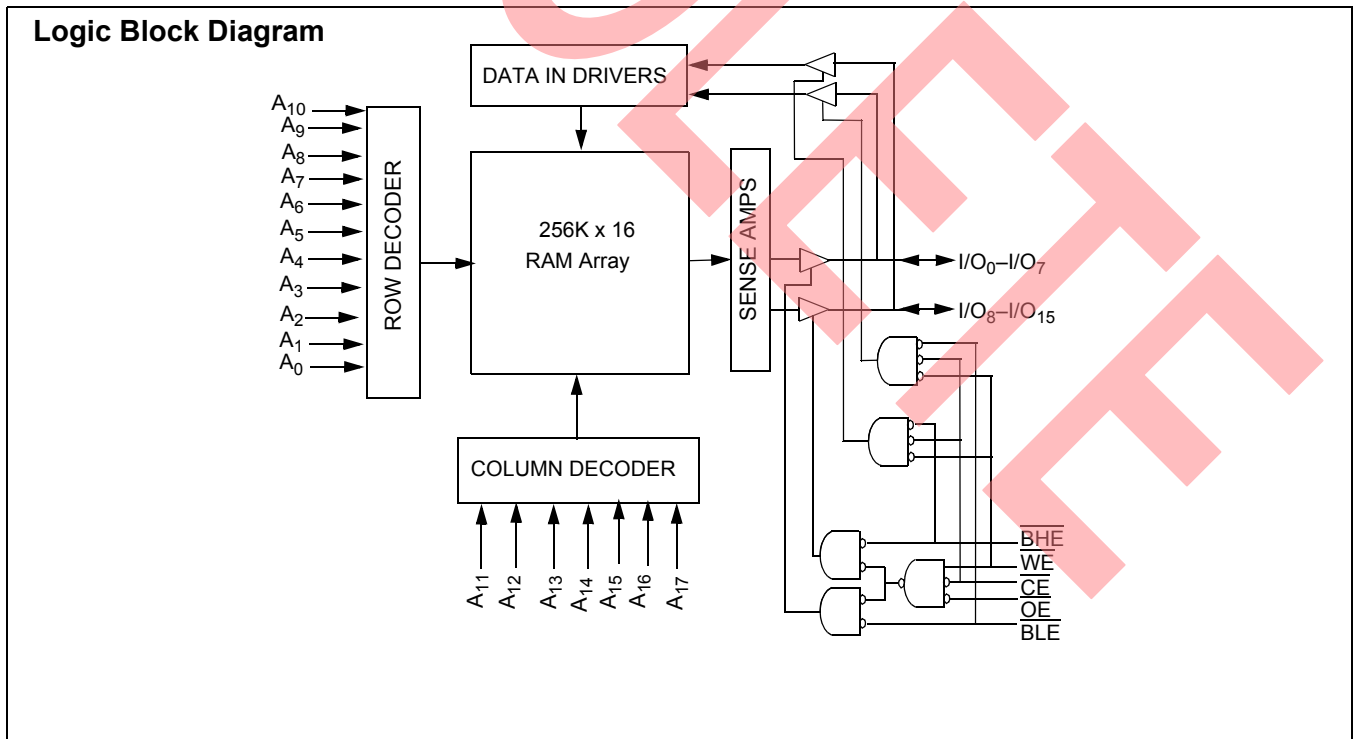

Note:

1. For best practice recommendations, please refer to the Cypress application note "System Design Guidelines" on <http://www.cypress.com>.

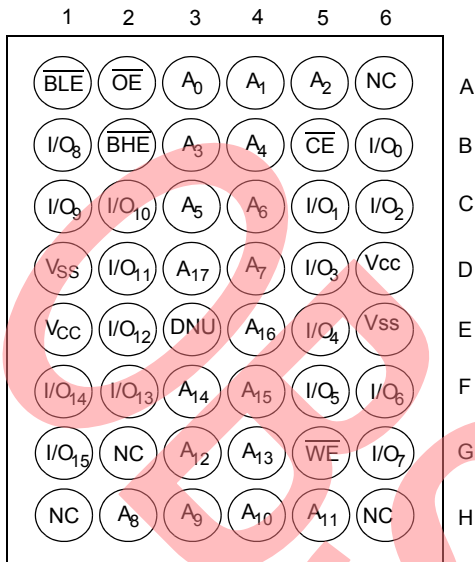
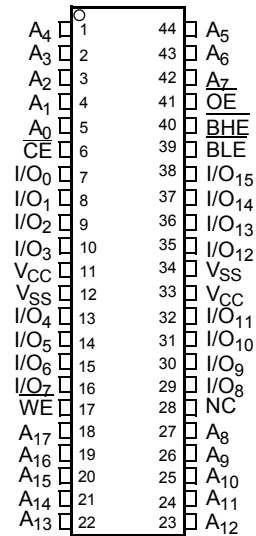
Pin Configuration^[2, 3, 4]
VFBGA (Top View)

44 TSOP II (Top View)

Product Portfolio

Product	V _{CC} Range (V)			Speed (ns)	Power Dissipation					
					Operating I _{CC} (mA)				Standby I _{SB2} (μA)	
	Min.	Typ. ^[5]	Max.		f = 1MHz		f = f _{max}			
Typ. ^[5]	Typ. ^[5]	Max.	Typ. ^[5]	Max.	Typ. ^[5]	Max.	Typ. ^[5]	Max.		
CY62146DV30L	2.20V	3.0	3.60	45	1.5	3	10	20	2	12
CY62146DV30LL										8
CY62146DV30L	2.20V	3.0	3.60	55	1.5	3	8	15	2	12
CY62146DV30LL										8
CY62146DV30L	2.20V	3.0	3.60	70	1.5	3	8	15	2	12
CY62146DV30LL										8

Notes:

- NC pins are not internally connected on the die.
- DNU pins have to be left floating or tied to V_{SS} to ensure proper application.
- Pins H1, G2, and H6 in the BGA package are address expansion pins for 8 Mb, 16 Mb, and 32 Mb, respectively.
- Typical values are included for reference only and are not guaranteed or tested. Typical values are measured at V_{CC} = V_{CC(typ.)}, T_A = 25°C.

Maximum Ratings

(Above which the useful life may be impaired. For user guidelines, not tested.)

Storage Temperature -65°C to +150°C

Ambient Temperature with

Power Applied -55°C to +125°C

Supply Voltage to Ground

Potential -0.3V to + V_{CC(MAX)} + 0.3V

DC Voltage Applied to Outputs

in High-Z State^[6, 7] -0.3V to V_{CC(MAX)} + 0.3V

DC Input Voltage^[6, 7] -0.3V to V_{CC(MAX)} + 0.3V

Output Current into Outputs (LOW) 20 mA

Static Discharge Voltage >2001V
(per MIL-STD-883, Method 3015)

Latch-up Current >200 mA

Operating Range

Device	Range	Ambient Temperature (T _A)	V _{CC} ^[8]
CY62146DV30L	Industrial	-40°C to +85°C	2.20V to 3.60V
CY62146DV30LL			

Electrical Characteristics Over the Operating Range

Parameter	Description	Test Conditions	CY62146DV30-45			CY62146DV30-55			CY62146DV30-70			Unit
			Min.	Typ. ^[5]	Max.	Min.	Typ. ^[5]	Max.	Min.	Typ. ^[5]	Max.	
V _{OH}	Output HIGH Voltage	I _{OH} = -0.1 mA, V _{CC} = 2.20V	2.0			2.0			2.0			V
		I _{OH} = -1.0 mA, V _{CC} = 2.70V	2.4			2.4			2.4			V
V _{OL}	Output LOW Voltage	I _{OL} = 0.1 mA, V _{CC} = 2.20V			0.4			0.4			0.4	V
		I _{OL} = 2.1 mA, V _{CC} = 2.70V			0.4			0.4			0.4	V
V _{IH}	Input HIGH Voltage	V _{CC} = 2.2V to 2.7V	1.8		V _{CC} + 0.3V	1.8		V _{CC} + 0.3V	1.8		V _{CC} + 0.3V	V
		V _{CC} = 2.7V to 3.6V	2.2		V _{CC} + 0.3V	2.2		V _{CC} + 0.3V	2.2		V _{CC} + 0.3V	V
V _{IL}	Input LOW Voltage	V _{CC} = 2.2V to 2.7V	-0.3		0.6	-0.3		0.6	-0.3		0.6	V
		V _{CC} = 2.7V to 3.6V	-0.3		0.8	-0.3		0.8	-0.3		0.8	V
I _{IX}	Input Leakage Current	GND ≤ V _I ≤ V _{CC}	-1		+1	-1		+1	-1		+1	μA
I _{OZ}	Output Leakage Current	GND ≤ V _O ≤ V _{CC} , Output Disabled	-1		+1	-1		+1	-1		+1	μA
I _{CC}	V _{CC} Operating Supply Current	f = f _{MAX} = 1/t _{RC} , V _{CC} = V _{CCmax} , I _{OUT} = 0 mA, CMOS levels		10	20		8	15		8	15	mA
		f = 1 MHz		1.5	3		1.5	3		1.5	3	mA
I _{SB1}	Automatic CE Power-down Current — CMOS Inputs	CE ≥ V _{CC} - 0.2V, V _{IN} ≥ V _{CC} - 0.2V, V _{IN} ≤ 0.2V, f = f _{MAX} (Address and Data Only), f = 0 (OE, WE, BHE and BLE), V _{CC} = 3.60V	L	2	12		2	12		2	12	μA
			LL			8			8			8
I _{SB2}	Automatic CE Power-down Current — CMOS Inputs	CE ≥ V _{CC} - 0.2V, V _{IN} ≥ V _{CC} - 0.2V or V _{IN} ≤ 0.2V, f = 0, V _{CC} = 3.60V	L	2	12		2	12		2	12	μA
			LL			8			8			8

Notes:

6. V_{IL(min)} = -2.0V for pulse durations less than 20 ns.

7. V_{IH(max)} = V_{CC} + 0.75V for pulse durations less than 20 ns.

8. Full device AC operation assumes a 100-μs ramp time from 0 to V_{CC(min)} and 200 μs wait time after V_{CC} stabilization.

Capacitance (for all packages)^[9]

Parameter	Description	Test Conditions	Max.	Unit
C _{IN}	Input Capacitance	T _A = 25°C, f = 1 MHz, V _{CC} = V _{CC(typ)}	10	pF
C _{OUT}	Output Capacitance		10	pF

Thermal Resistance^[9]

Parameter	Description	Test Conditions	BGA	TSOP II	Unit
θ _{JA}	Thermal Resistance (Junction to Ambient)	Still Air, soldered on a 3 × 4.5 inch, four-layer printed circuit board	72	75.13	°C/W
θ _{JC}	Thermal Resistance (Junction to Case)		8.86	8.95	°C/W

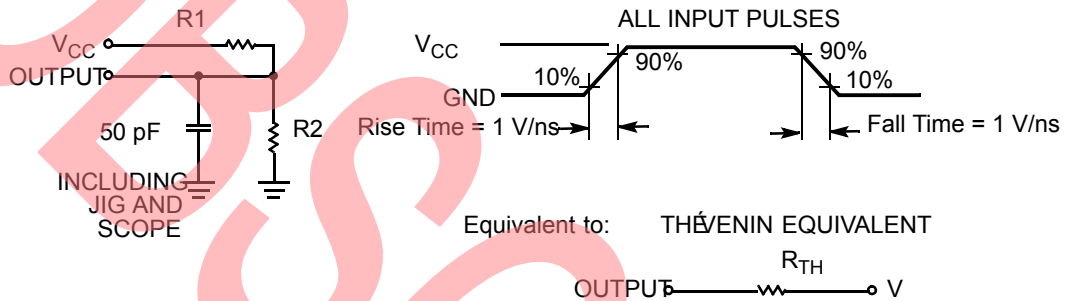
AC Test Loads and Waveforms^[10]

Parameters	2.50V	3.0V	Unit
R1	16667	1103	Ω
R2	15385	1554	Ω
R _{TH}	8000	645	Ω
V _{TH}	1.20	1.75	V

Data Retention Characteristics (Over the Operating Range)

Parameter	Description	Conditions	Min.	Typ. ^[5]	Max.	Unit
V _{DR}	V _{CC} for Data Retention		1.5			V
I _{CCDR}	Data Retention Current	V _{CC} = 1.5V CE ≥ V _{CC} - 0.2V, V _{IN} ≥ V _{CC} - 0.2V or V _{IN} ≤ 0.2V	L		9	μA
			LL		6	
t _{CDR} ^[9]	Chip Deselect to Data Retention Time		0			ns
t _R ^[11]	Operation Recovery Time		t _{RC}			ns

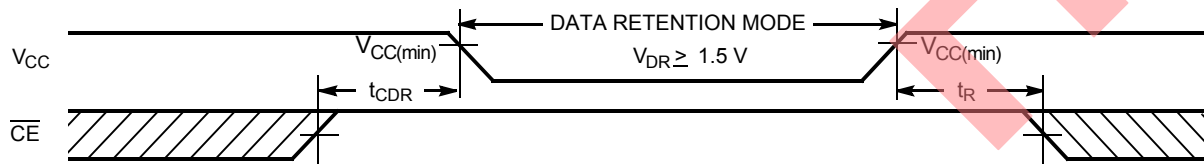
Data Retention Waveform

Notes:

9. Tested initially and after any design or process changes that may affect these parameters.
10. Test condition for the 45 ns part is a load capacitance of 30 pF.
11. Full device operation requires linear V_{CC} ramp from V_{DR} to V_{CC(min.)} ≥ 100 μs or stable at V_{CC(min.)} ≥ 100 μs.

Switching Characteristics Over the Operating Range ^[12]

Parameter	Description	45 ns ^[10]		55 ns		70 ns		Unit
		Min.	Max.	Min.	Max.	Min.	Max.	
Read Cycle								
t _{RC}	Read Cycle Time	45		55		70		ns
t _{AA}	Address to Data Valid		45		55		70	ns
t _{OHA}	Data Hold from Address Change	10		10		10		ns
t _{ACE}	\overline{CE} LOW to Data Valid		45		55		70	ns
t _{DOE}	\overline{OE} LOW to Data Valid		25		25		35	ns
t _{LZOE}	\overline{OE} LOW to Low Z ^[13]	5		5		5		ns
t _{HZOE}	\overline{OE} HIGH to High Z ^[13, 14]		15		20		25	ns
t _{LZCE}	\overline{CE} LOW to Low Z ^[13]	10		10		10		ns
t _{HZCE}	\overline{CE} HIGH to High Z ^[13, 14]		20		20		25	ns
t _{PU}	\overline{CE} LOW to Power-Up	0		0		0		ns
t _{PD}	\overline{CE} HIGH to Power-Down		45		55		70	ns
t _{DBE}	$\overline{BLE}/\overline{BHE}$ LOW to Data Valid		25		25		35	ns
t _{LZBE}	$\overline{BLE}/\overline{BHE}$ LOW to Low Z ^[13]	10		10		10		ns
t _{HZBE}	$\overline{BLE}/\overline{BHE}$ HIGH to HIGH Z ^[13, 14]		15		20		25	ns
Write Cycle^[15]								
t _{WC}	Write Cycle Time	45		55		70		ns
t _{SCE}	\overline{CE} LOW to Write End	40		40		60		ns
t _{AW}	Address Set-up to Write End	40		40		60		ns
t _{HA}	Address Hold from Write End	0		0		0		ns
t _{SA}	Address Set-up to Write Start	0		0		0		ns
t _{PWE}	\overline{WE} Pulse Width	35		40		45		ns
t _{BW}	$\overline{BLE}/\overline{BHE}$ LOW to Write End	40		40		60		ns
t _{SD}	Data Set-up to Write End	25		25		30		ns
t _{HD}	Data Hold from Write End	0		0		0		ns
t _{HZWE}	\overline{WE} LOW to High-Z ^[13, 14]		15		20		25	ns
t _{LZWE}	\overline{WE} HIGH to Low-Z ^[13]	10		10		10		ns

Notes:

12. Test conditions for all parameters other than three-state parameters assume signal transition time of 3 ns (1V/ns) or less, timing reference levels of $V_{CC(typ)}/2$, input pulse levels of 0 to $V_{CC(typ)}$, and output loading of the specified I_{OL}/I_{OH} as shown in the "AC Test Loads and Waveforms" section.
13. At any given temperature and voltage condition, t_{HZCE} is less than t_{LZCE}, t_{HZBE} is less than t_{LZBE}, t_{HZOE} is less than t_{LZOE}, and t_{HZWE} is less than t_{LZWE} for any given device.
14. t_{HZOE}, t_{HZCE}, t_{HZBE}, and t_{HZWE} transitions are measured when the outputs enter a high-impedance state.
15. The internal Write time of the memory is defined by the overlap of \overline{WE} , $\overline{CE} = V_{IL}$, \overline{BHE} and/or $\overline{BLE} = V_{IL}$. All signals must be ACTIVE to initiate a write and any of these signals can terminate a write by going INACTIVE. The data input set-up and hold timing should be referenced to the edge of the signal that terminates the write.

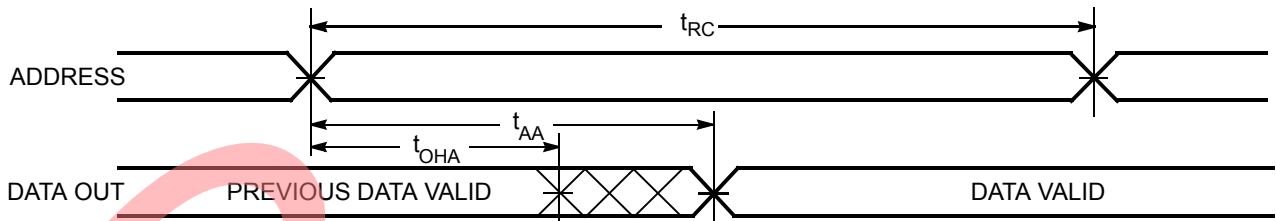
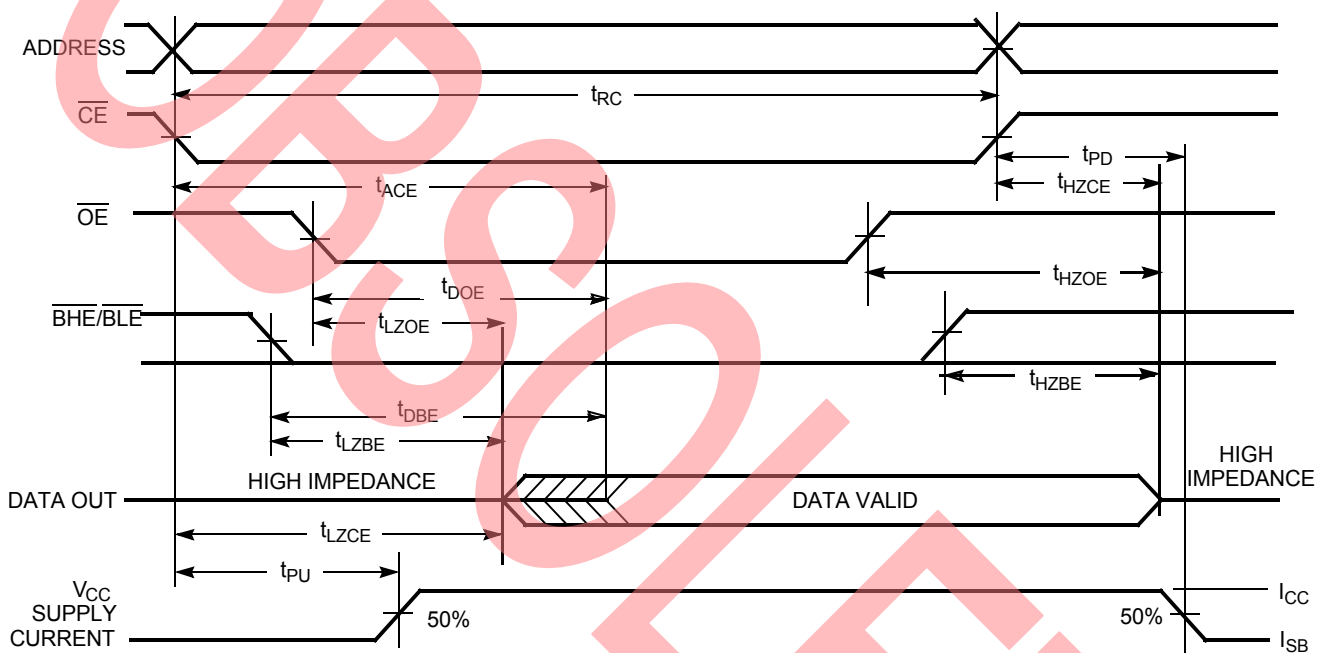
Switching Waveforms
Read Cycle 1 (Address Transition Controlled)^[16, 17]

Read Cycle No. 2 (OE Controlled)^[17, 18]

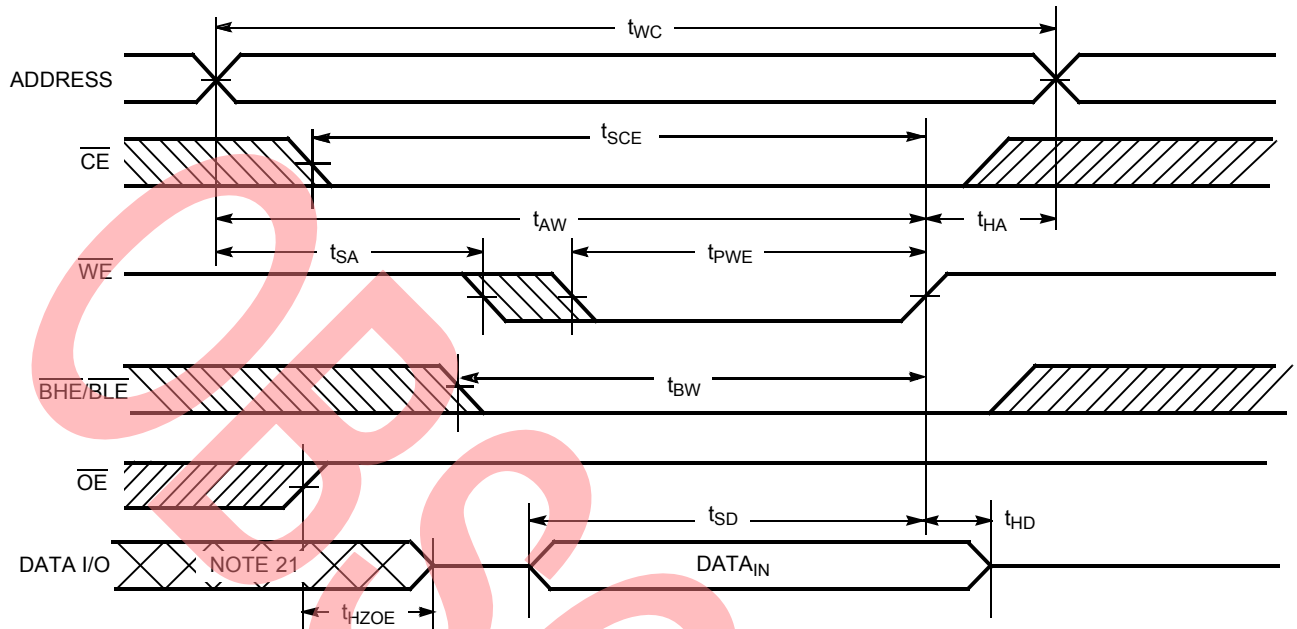
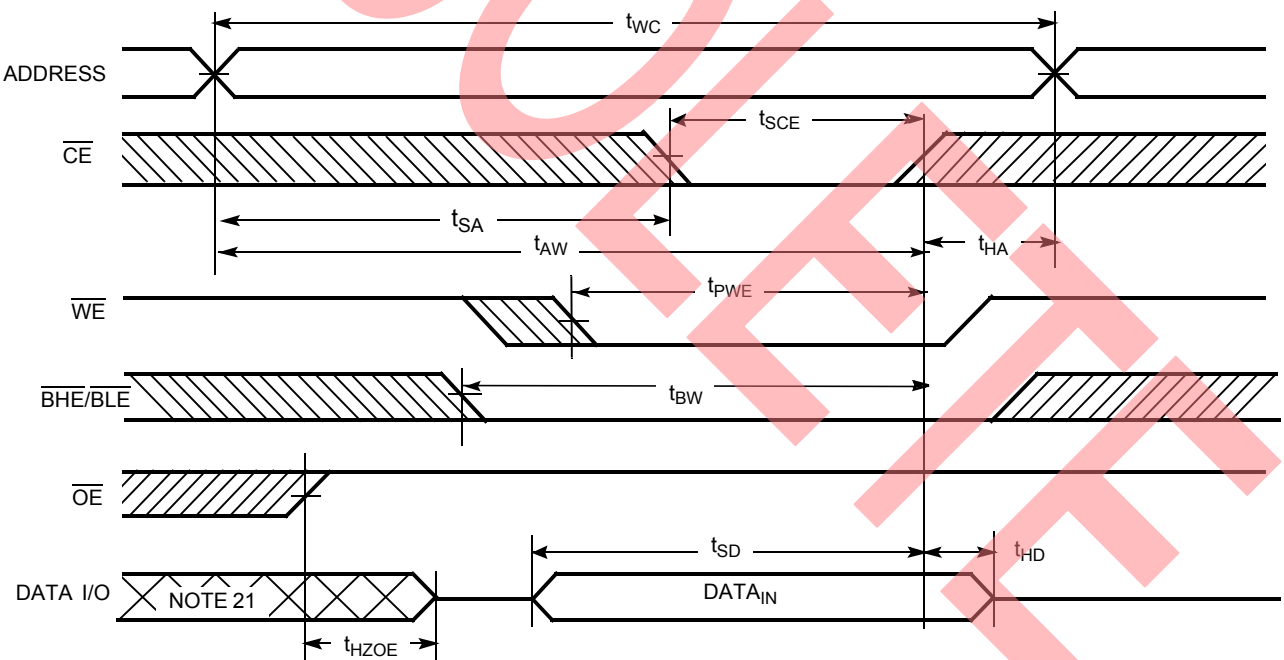
Notes:

- 16. The device is continuously selected. \overline{OE} , $\overline{CE} = V_{IL}$, \overline{BHE} and/or $\overline{BLE} = V_{IL}$.
- 17. \overline{WE} is HIGH for read cycle.
- 18. Address valid prior to or coincident with \overline{CE} and \overline{BHE} , \overline{BLE} transition LOW.

Switching Waveforms (continued)
Write Cycle No. 1 ($\overline{\text{WE}}$ Controlled)^[15, 19, 20]

Write Cycle No. 2 ($\overline{\text{CE}}$ Controlled)^[15, 19, 20]

Notes:

19. Data I/O is high impedance if $\overline{\text{OE}} = V_{\text{IH}}$.
20. If $\overline{\text{CE}}$ goes HIGH simultaneously with $\overline{\text{WE}} = V_{\text{IH}}$, the output remains in a high-impedance state.
21. During this period, the I/Os are in output state and input signals should not be applied.

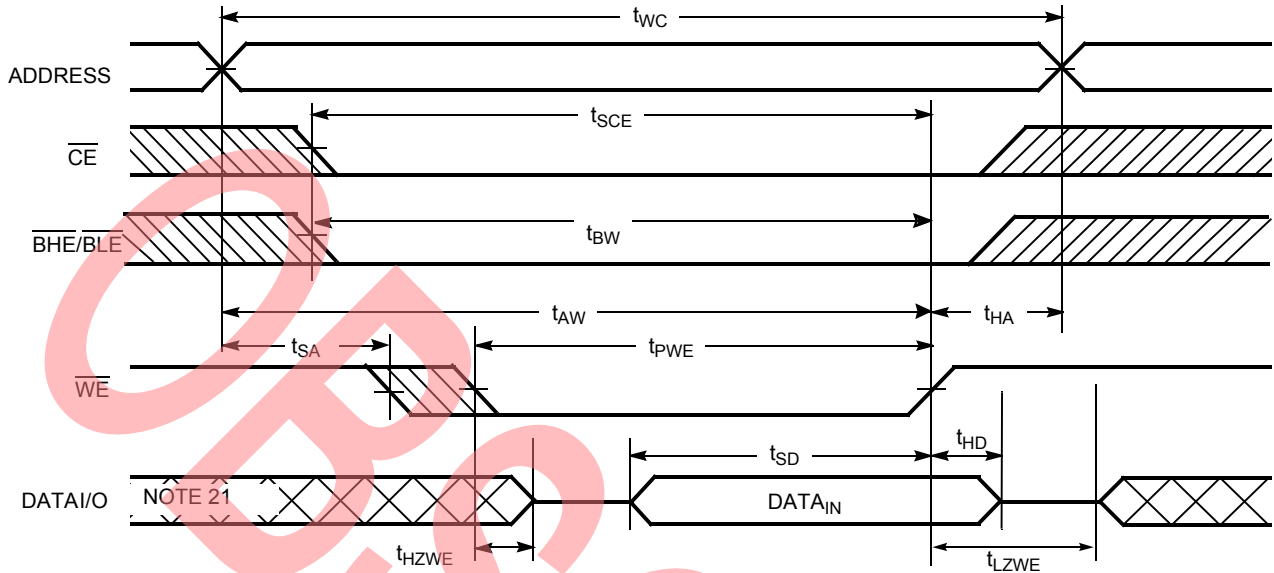
Switching Waveforms (continued)

Write Cycle No. 3 (\overline{WE} Controlled, \overline{OE} LOW)^[20]



Write Cycle No. 4 ($\overline{BHE}/\overline{BLE}$ Controlled, \overline{OE} LOW)^[20]

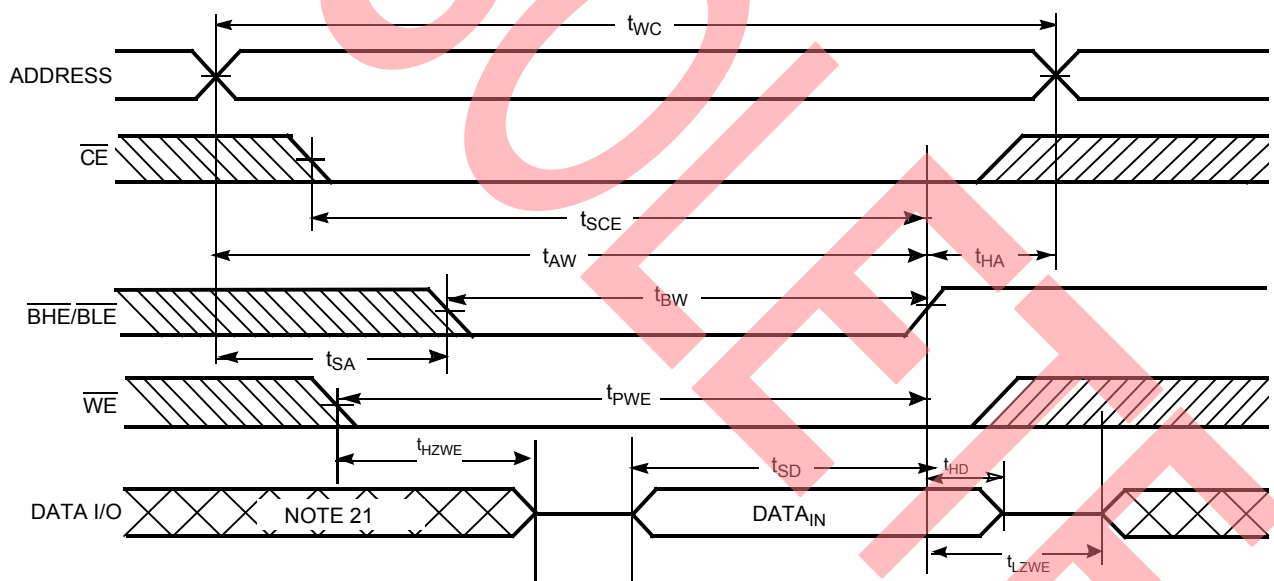

Truth Table

\overline{CE}	\overline{WE}	\overline{OE}	\overline{BHE}	\overline{BLE}	Inputs/Outputs	Mode	Power
H	X	X	X	X	High Z	Deselect/Power-Down	Standby (I_{SB})
L	X	X	H	H	High Z	Output Disabled	Active (I_{CC})
L	H	L	L	L	Data Out (I/O_0 - I/O_{15})	Read	Active (I_{CC})
L	H	L	H	L	Data Out (I/O_0 - I/O_7); I/O_8 - I/O_{15} in High Z	Read	Active (I_{CC})
L	H	L	L	H	Data Out (I/O_8 - I/O_{15}); I/O_0 - I/O_7 in High Z	Read	Active (I_{CC})
L	H	H	L	L	High Z	Output Disabled	Active (I_{CC})
L	H	H	H	L	High Z	Output Disabled	Active (I_{CC})
L	H	H	L	H	High Z	Output Disabled	Active (I_{CC})
L	L	X	L	L	Data In (I/O_0 - I/O_{15})	Write	Active (I_{CC})
L	L	X	H	L	Data In (I/O_0 - I/O_7); I/O_8 - I/O_{15} in High Z	Write	Active (I_{CC})
L	L	X	L	H	Data In (I/O_8 - I/O_{15}); I/O_0 - I/O_7 in High Z	Write	Active (I_{CC})

Ordering Information

Speed (ns)	Ordering Code	Package Name	Package Type	Operating Range
45	CY62146DV30LL-45BVI	BV48A	48-ball Very Fine Pitch BGA (6 mm × 8mm × 1 mm)	Industrial
	CY62146DV30LL-45BVXI		48-ball Very Fine Pitch BGA (6 mm × 8mm × 1 mm) (Pb-free)	
	CY62146DV30LL-45ZSXI	ZS-44	44-pin TSOP II (Pb-free)	
55	CY62146DV30L-55BVI	BV48A	48-ball Very Fine Pitch BGA (6 mm × 8mm × 1 mm)	Industrial
	CY62146DV30L-55BVXI		48-ball Very Fine Pitch BGA (6 mm × 8mm × 1 mm) (Pb-free)	
	CY62146DV30LL-55BVI		48-ball Very Fine Pitch BGA (6 mm × 8mm × 1 mm)	
	CY62146DV30LL-55BVXI		48-ball Very Fine Pitch BGA (6 mm × 8mm × 1 mm) (Pb-free)	
	CY62146DV30L-55ZSXI	ZS-44	44-pin TSOP II (Pb-free)	
	CY62146DV30LL-55ZSXI			
70	CY62146DV30L-70BVI	BV48A	48-ball Very Fine Pitch BGA (6 mm × 8mm × 1 mm)	Industrial
	CY62146DV30L-70BVXI		48-ball Very Fine Pitch BGA (6 mm × 8mm × 1 mm) (Pb-free)	
	CY62146DV30LL-70BVI		48-ball Very Fine Pitch BGA (6 mm × 8mm × 1 mm)	
	CY62146DV30LL-70BVXI		48-ball Very Fine Pitch BGA (6 mm × 8mm × 1 mm) (Pb-free)	
	CY62146DV30L-70ZSXI	ZS-44	44-pin TSOP II (Pb-free)	Industrial
	CY62146DV30LL-70ZSXI			

Document History Page

Document Title: CY62146DV30 MoBL [®] 4-Mbit (256K x 16) Static RAM				
Document Number: 38-05339				
REV.	ECN NO.	Issue Date	Orig. of Change	Description of Change
**	213251	See ECN	AJU	New Data Sheet
*A	316039	See ECN	PCI	Added 45-ns Speed Bin in AC, DC and Ordering Information tables Added Footnote #10 on page #4 Added Pb-free package ordering information on page # 9 Changed 44-lead TSOP-II package name on page 10 from Z44 to ZS44 Standardized Icc values across 'L' and 'LL' bins
*B	3094410	11/24/2010	RAME	The parts specified in the ordering information table are being pruned. Obsolete Datasheet.

OBSOLETE