

Main technical indicators(主要技术指标)	
1.Mating (插拔次数)	5000
2.Working Temperature (温度)	-55~+150 °C
3.IP Rating (防护级别)	IP 50
4.Diameter of socket end(插合端直径)	φ1.3
5.Testing Voltage (测试电压)	1650V
6.Working Voltage (工作电压)	1150V
7.Rated Current (额定电流)	13A
8.Shell material(壳体材质)	Brass (chromium plating) shell and chuck nut/(nickel plating) pin sleeve and middleware/黄铜(镀铬)外壳和夹头螺母/(镀镍)插销套和中间件
9.Pin Material(插针材料)	Copper alloy gold plating(铜合金镀金)
10.Insulator material(绝缘体材质)	L:PPS P:PEEK

Sum up(总结)	
Series(系列)	B
Shell style/model (外壳样式/型号)	THG: Elbow plug, cable collet/电缆夹头弯头
Button (按键)	A button(一个按键)
Termination type (终止类型)	Male solder(公焊锡)
Line diameter awg(线材直径)	28-20AWG
Cable diameterφ (电缆直径)	φ8.3-9.2MM
Matching parts(配件)	ZGG.3B.P08.CXL

Location pin combination(定位销组合)			
(编号) Number	Number of positioning pins(定位销数量)	Angle(角度)	Series(系列)--3B
G	One(1)		(Zero degrees)0°
A	Two(2)	A	Thirty degrees(30°)
B	Two(2)		Forty-five degrees(45°)
C	Two(2)		Sixty degrees(60°)
D	Two(2)	γ	95 degrees (95°)
E	Two(2)	β	120 degrees(120°)
F	Two(2)		145 degrees(145°)
J	Two(2)	A	37.5degrees(37.5°)
K	Two(2)		52.5degrees(52.5°)
L	Two(2)	γ	Seventy degrees(70°)

	A	B	C√	ANGLE	
5-10	±0.02	±0.05	±0.1	0°-30°	±0.1°
50-100	±0.1	±0.15	±0.2	61°-90°	±0.5°
50-100	±0.15	±0.2	±0.25		
100-	±0.15%	±0.20%	±0.25%		

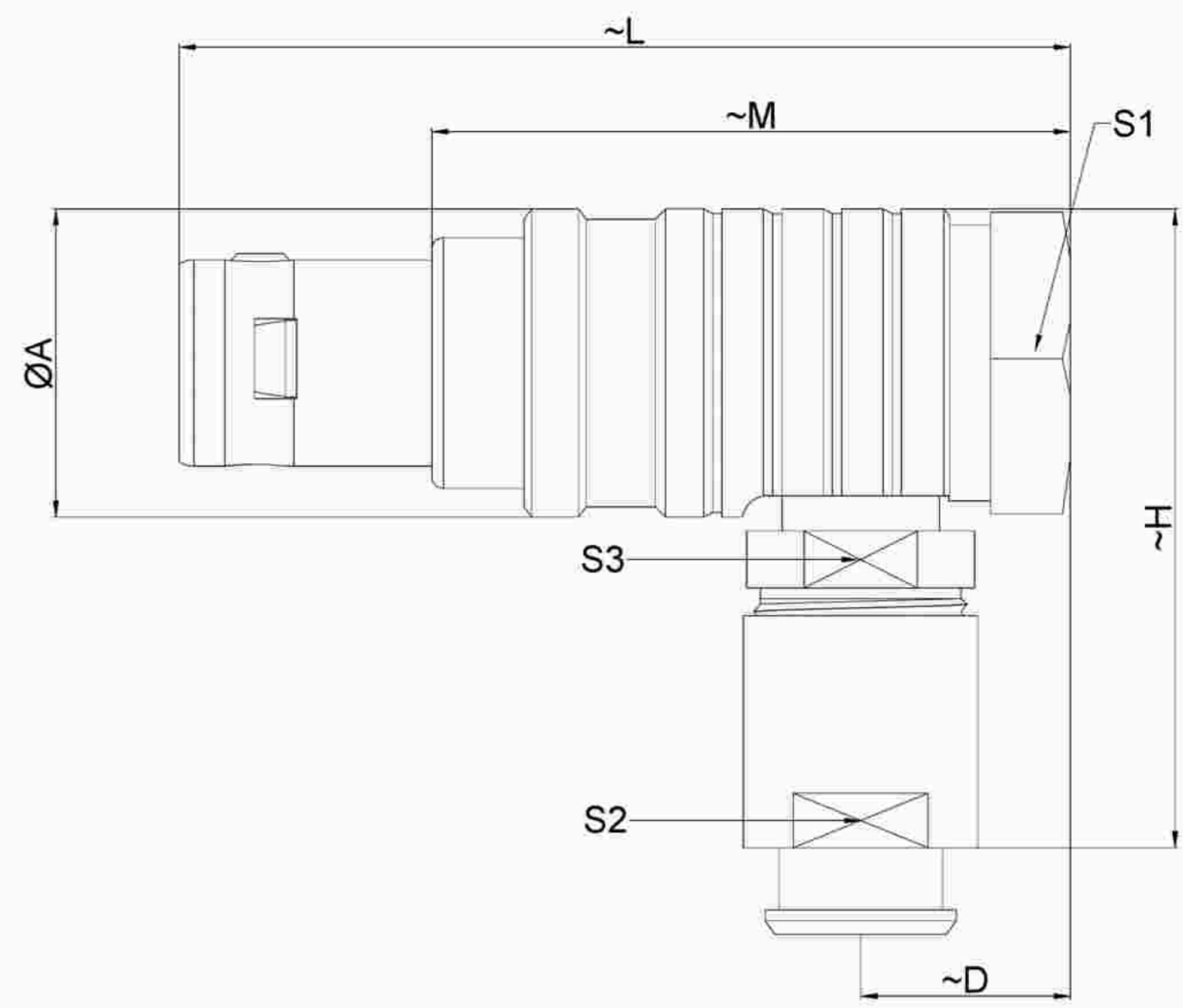

	A	D	H	L	M	S1	S2	S3
MM	19	10	36	50.0	35	17	15	15
in	0.748	0.3937	1.4173	1.9685	1.378	0.6693	0.5906	0.5906

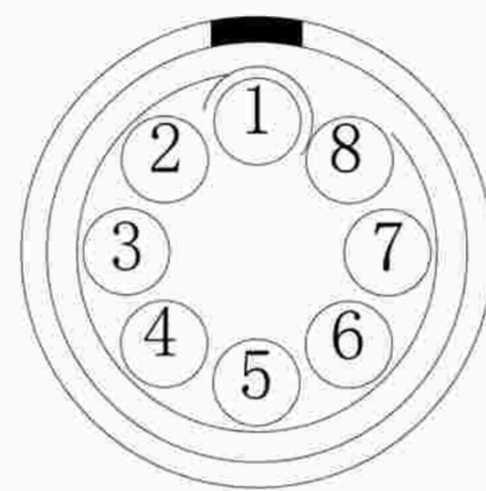

Welded surface
(焊接面)

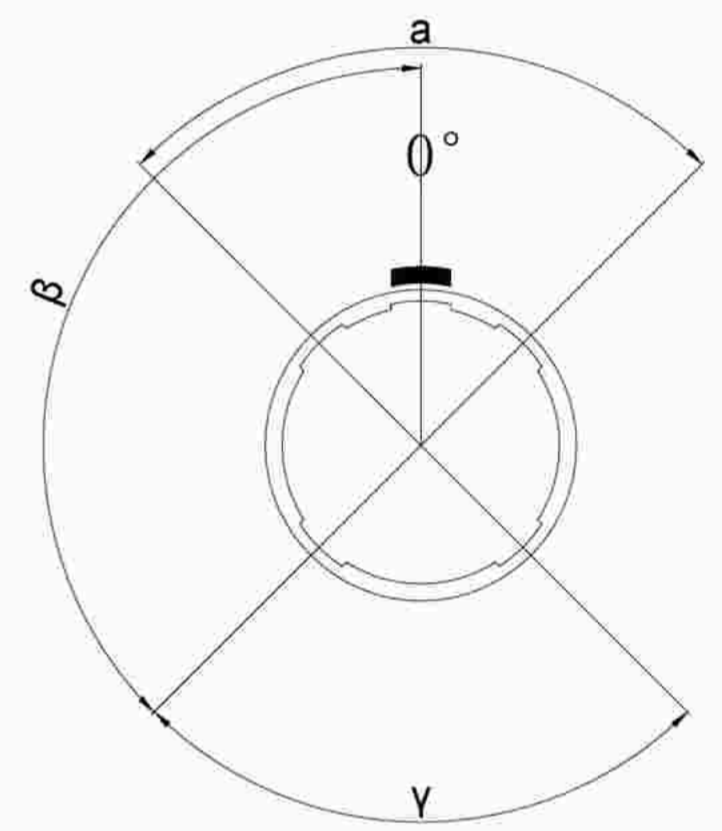

Positive view
(正视图)

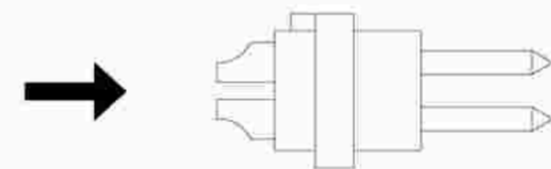

Solder core
(焊接型公胶芯)

TH G. 3B. P08.C X A D 92 H

Model(型号)

Positioning pin(定位销)

Series(系列)

Needle core configuration(针芯配置)

Outer casing(外壳)

Insulator(绝缘体)

Needle core(针芯)

Type of CXamp(线夹类型)

Cable diameter(电缆直径)

SH means a sheath type, not a cover type.

(H表示护套型, 不表示为不带护套型)

DESIGNED(设计)
广东星坤科技股份有限公司
CHECKED(校对)

APPROVED(审核)
日期

REVISIONS

文件工程章

www.helloxkb.com www.helloxkb.cn

DATE(日期)	
DATE(日期)	
DATE(日期)	

SCALE(比例)	N/A(不适用)
VIEW(视图)	
UNIT(单位)	MM

MATERIAL (材料)	
---------------	--

MODEL TYPE	型号类型: THG.3B.P08.CXAD92H
PART NO.	名称: 3B8-core plug
DWG NO.:	3B8芯插头

WEIGHT(重量)	SHEET(表)	REVISION(修订)
	1/1	A0