

High Efficiency, Dual Independent 2A Flash LED Driver

Features

- Dual Independent and Programmable 2A LED Current Source
 - Flash: 3.91mA~2.0A, 256 levels
7.83mA/level
 - Torch: 0.93mA~475mA, 256 levels
1.86mA/level
 - Flash Timeout: 40ms~1.6s, 16 levels
 - Flash/Torch/IR Mode
- Up to 83% Flash Efficiency
- Optimized Flash LED Current During Low Battery Conditions (IVFM)
- Hardware Flash/Torch Enable (STROBE/TORCH)
- Synchronization Input for RF Power Amplifier Pulse Events (TX)
- 400kHz I²C: AW36515A (I²C Address=0x63)
- 0.4mm Pitch, FCQFN 1.6mm×1.2mm×0.55mm -10L Package
Compatible with AW3643, AW3644, AW36413

Application

Smartphone Camera Flash

General Description

The AW36515A is a dual LED flash driver that provides a high level of adjustability within a small solution size. The AW36515A utilizes a 2MHz or 4MHz fixed-frequency synchronous boost converter to provide power to the dual 2A constant current LED sources. The dual 256 levels current sources provide the flexibility to adjust the current of LED1 and LED2 in Flash/Torch/IR modes. The AW36515A provides IVFM protection to prevent system reset or shutdown under low battery condition.

The AW36515A are controlled via an I²C - compatible interface. The main features of the AW36515A include: flash/torch current, flash timeout duration, IVFM and TX interrupt. The AW36515A also provides hardware flash/torch pin (STROBE/TORCH) to control Flash/Torch events.

The 2MHz or 4MHz switching frequency options, overvoltage protection (OVP), and adjustable current limit allow for the use of tiny, low-profile inductors and 10-μF ceramic capacitors. The device operates over a -40°C to +85°C ambient temperature range.

The AW36515A is available in small 0.4mm pitch FCQFN 1.6mm×1.2mm×0.55mm -10L package.

Typical Application Circuit

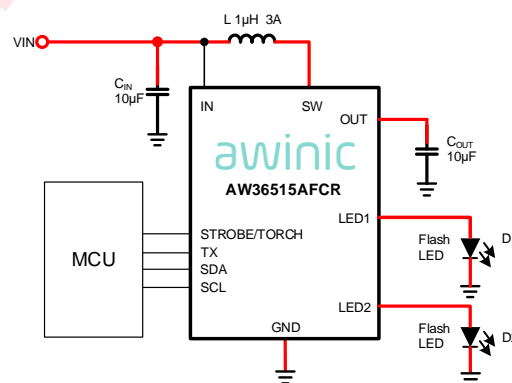

Typical Application Circuit of AW36515A

Pin Configuration And Top Mark

AW36515AFCR Pin Configuration
(Top View)

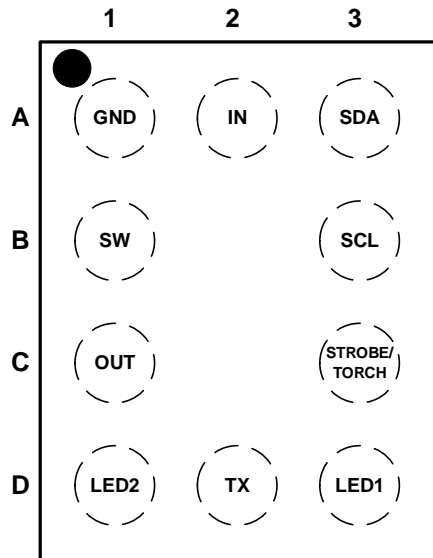

AW36515AFCR Top Mark
(Top View)

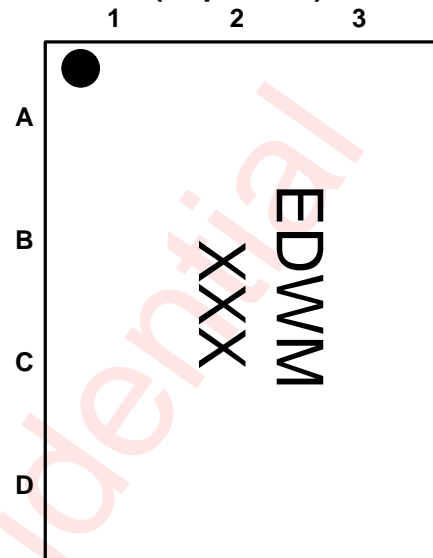

EDWM – AW36515AFCR

XXX – Production Tracing Code

Pin Configuration and Top Mark

Pin Definition

| No. | NAME | TYPE | DESCRIPTION |
|-----|--------------|--------|---|
| A1 | GND | Ground | Ground |
| A2 | IN | Power | Input voltage connection. Connect IN to GND with a 10 μ F or larger ceramic capacitor. |
| A3 | SDA | I/O | Serial data input/output of the I ² C interface. |
| B1 | SW | Power | Switch pin of the step-up DC-DC convertor. |
| B3 | SCL | I/O | Serial clock input of the I ² C interface. |
| C1 | OUT | Power | Step-up DC-DC converter output. Connect a 10 μ F ceramic capacitor between OUT and GND. |
| C3 | STROBE/TORCH | I/O | Active high hardware flash/torch/IR enable. Drive STROBE/TORCH high to turn on Flash/Torch/IR pulse. Internal pull down resistor of 300k Ω between STROBE/TORCH and GND. |
| D1 | LED2 | Power | High-side current source output for flash LED2. |
| D2 | TX | I/O | Power amplifier synchronization input. Internal pull down resistor of 300k Ω between TX and GND. |
| D3 | LED1 | Power | High-side current source output for flash LED1. |

Typical Application Circuits

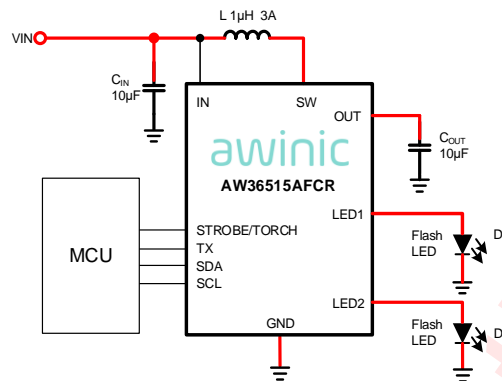

AW36515A Application Circuit

Notice for Typical Application Circuits:

- 1: Please place C_{IN} , C_{OUT} as close to the chip as possible.
- 2: Connect the inductor on the top layer close to the SW pin.
- 3: For the sake of driving capability, the power lines, output lines, and the connection lines of L and LED should be short and wide as possible.
- 4: Traces carry high current are marked in red in the above figure.

Ordering Information

| Part Number | Temperature | Package | Marking | Moisture Sensitivity Level | Environmental Information | Delivery Form |
|-------------|-------------|-------------------------------------|---------|----------------------------|---------------------------|------------------------------|
| AW36515AFCR | -40°C~85°C | FCQFN 1.6mmX1.2mm x0.55mm-10L | EDWM | MSL1 | ROHS+HF | 3000 units/ Tape and Reel |

Absolute Maximum Ratings^(NOTE1)

| PARAMETERS | | Range | Unit |
|---|-----|------------------------|-------|
| IN, SW, OUT, LED1, LED2 | | -0.3 to 6 | V |
| SCL, SDA, STROBE/TORCH, TX | | -0.3 to (VIN+0.3) | V |
| Continuous power dissipation | | Internally limited | |
| Max Junction Temperature T _{JMAX} | | 155 | °C |
| Storage Temperature T _{STG} | | -65 to 150 | °C |
| Maximum lead temperature (soldering) | | 260 | °C |
| Junction to Ambient Thermal Resistance θ_{JA} | | 92 | °C /W |
| ESD, All Pins ^(NOTE2) | HBM | ±2000 | V |
| | CDM | ±1500 | V |
| Latch-Up (Test method: JEDEC STANDARD NO.78F NOVEMBER 2016) | | +IT: +200 -IT: -200 | mA |

Recommended Operating Conditions

| PARAMETERS | | Range | Unit |
|--|--|------------|------|
| V _{IN} | | 2.7 to 5.5 | V |
| Junction temperature (T _J) | | -40 to 125 | °C |
| Ambient temperature (T _A) | | -40 to 85 | °C |

NOTE1: Conditions out of those ranges listed in "absolute maximum ratings" may cause permanent damages to the device. In spite of the limits above, functional operation conditions of the device should within the ranges listed in "recommended operating conditions". Exposure to absolute-maximum-rated conditions for prolonged periods may affect device reliability.

NOTE2: The human body model is a 100pF capacitor discharged through a 1.5kΩ resistor into each pin. Test method: ANSI/ESDA/JEDEC JS-001-2017. CDM test method: JEDEC EIA/JESD22-C101F.

Electrical Characteristics

Typical values tested at $T_A=25^{\circ}\text{C}$. Minimum and maximum limits apply over the full operating ambient temperature range ($-40^{\circ}\text{C}\leq T_A\leq 85^{\circ}\text{C}$). Unless otherwise specified, $V_{IN}=3.6\text{V}$.

| Symbol | Description | Test Condition | Min | Typ | Max | Unit |
|---------------------------------------|--|---|------|-----|------|--------------------|
| Vin Supply | | | | | | |
| V_{IN} | Input operating range | | 2.7 | | 5.5 | V |
| I_Q | Quiescent supply current | Device not switching, pass mode | | 0.4 | 0.8 | mA |
| I_{SB} | Standby supply current | Device disabled, $2.7\text{V}\leq V_{IN}\leq 5.5\text{V}, \text{SCL}=\text{SDA}=0\text{V}$ | | 3 | 10 | μA |
| UVLO | Under voltage lockout threshold | Falling V_{IN} | | 2.5 | | V |
| | | Rising V_{IN} | | 2.6 | | V |
| Current Source Specifications | | | | | | |
| $I_{LED1/2}$ | Current source accuracy | $V_{OUT}=4\text{V}$, flash code=0xFF=2.0A | 1.84 | 2.0 | 2.16 | A |
| | | $V_{OUT}=4\text{V}$, torch code=0x7F=237mA | 213 | 237 | 261 | mA |
| V_{OVP} | V_{OUT} over-voltage protect threshold | ON threshold | 4.85 | 5 | 5.15 | V |
| | | OFF threshold | 4.75 | 4.9 | 5.05 | |
| Boost Converter Specifications | | | | | | |
| R_{PMOS} | PMOS switch on-resistance | | | 110 | | $\text{m}\Omega$ |
| R_{NMOS} | NMOS switch on-resistance | | | 90 | | $\text{m}\Omega$ |
| I_{CL} | Switch current limit | Reg 0x07, bit[0]=0 | 1.67 | 1.9 | 2.13 | A |
| | | Reg 0x07, bit[0]=1 | 2.46 | 2.8 | 3.14 | |
| F_{SW} | Switching frequency | Reg 0x07, bit[1]=0 | 1.88 | 2 | 2.12 | MHz |
| | | Reg 0x07, bit[1]=1 | 3.76 | 4 | 4.24 | |
| V_{IVFM} | Input voltage flash monitor trip threshold | Reg 0x02, bits[5:3]="000" | 2.81 | 2.9 | 2.99 | V |
| T_{SD} | Thermal shutdown threshold | | | 155 | | $^{\circ}\text{C}$ |
| | Thermal shutdown hysteresis | | | 20 | | |

Typical values tested at $T_A=25^{\circ}\text{C}$. Minimum and maximum limits apply over the full operating ambient temperature range ($-40^{\circ}\text{C}\leq T_A\leq 85^{\circ}\text{C}$). Unless otherwise specified, $V_{IN}=3.6\text{V}$.

| Symbol | Description | Test Condition | Min | Typ | Max | Unit |
|--|------------------------------|-----------------------|-----|-----|----------|-----------|
| I²C-Compatible Interface Specifications(SCL,SDA) | | | | | | |
| V_{IL} | Input logic low | | 0 | | 0.4 | V |
| V_{IH} | Input logic high | | 1.2 | | V_{IN} | V |
| V_{OL} | Output logic low | $I_{LOAD}=3\text{mA}$ | | | 0.4 | V |
| STROBE/TORCH, TX Voltage Specifications | | | | | | |
| V_{IL} | Input logic low | | 0 | | 0.4 | V |
| V_{IH} | Input logic high | | 1.2 | | V_{IN} | V |
| R_{PD} | Internal pull down resistors | | | 300 | | $k\Omega$ |

I²C Interface Timing

| Symbol | Description | Min | Typ | Max | Units |
|----------------------------|---|-----|-----|-----|-------|
| F _{SCL} | Interface Clock frequency | | | 400 | kHz |
| T _{DEGLITCH} H | Deglitch time | SCL | 200 | | ns |
| | | SDA | 250 | | ns |
| T _{HD:STA} | (Repeat-start) Start condition hold time | 0.6 | | | μs |
| T _{LOW} | Low level width of SCL | 1.3 | | | μs |
| T _{HIGH} | High level width of SCL | 0.6 | | | μs |
| T _{SU:STA} | (Repeat-start) Start condition setup time | 0.6 | | | μs |
| T _{HD:DAT} | Data hold time | 0 | | | μs |
| T _{SU:DAT} | Data setup time | 0.1 | | | μs |
| T _R | Rising time of SDA and SCL | | | 0.3 | μs |
| T _F | Falling time of SDA and SCL | | | 0.3 | μs |
| T _{SU:STO} | Stop condition setup time | 0.6 | | | μs |
| T _{BUF} | Time between start and stop condition | 1.3 | | | μs |

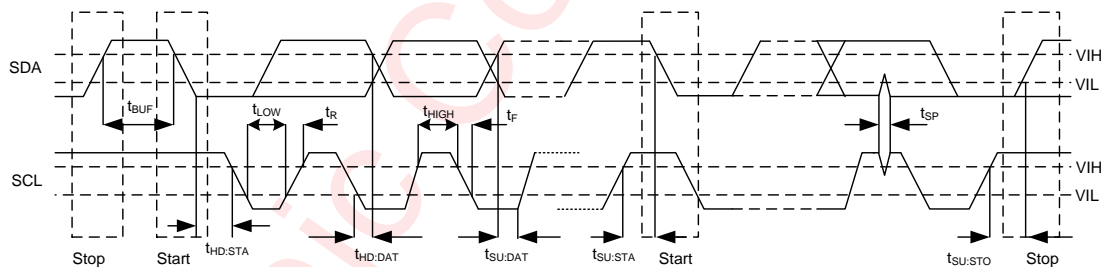
I²C INTERFACE TIMING

Typical Characteristics

Ambient temperature is 25°C, input voltage is 3.6 V, $C_{IN} = C_{OUT} = 10 \mu F$ and $L=1 \mu H$, unless otherwise noted .

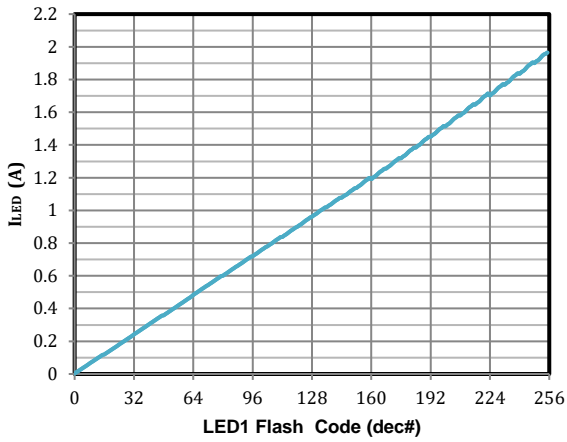

LED1 Flash Current vs Brightness Code

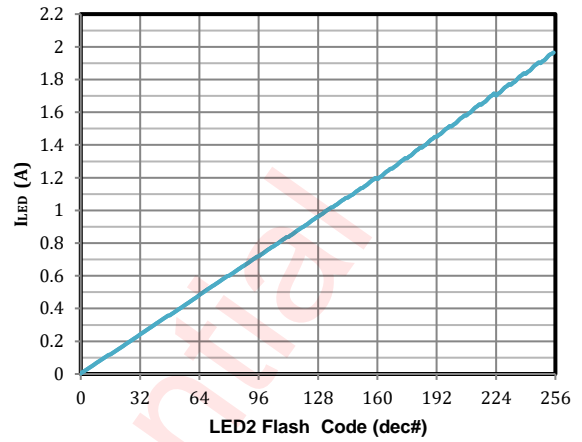

LED2 Flash Current vs Brightness Code

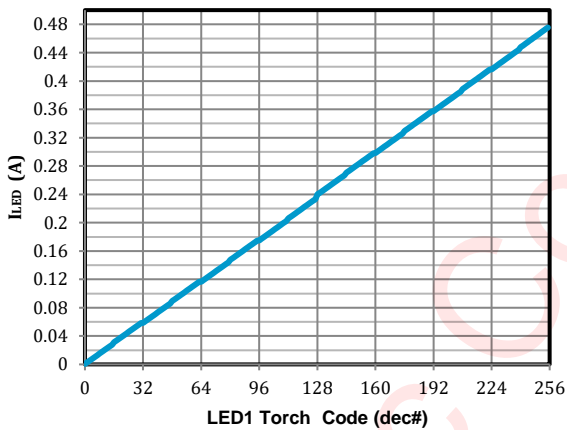

LED1 Torch Current vs Brightness Code

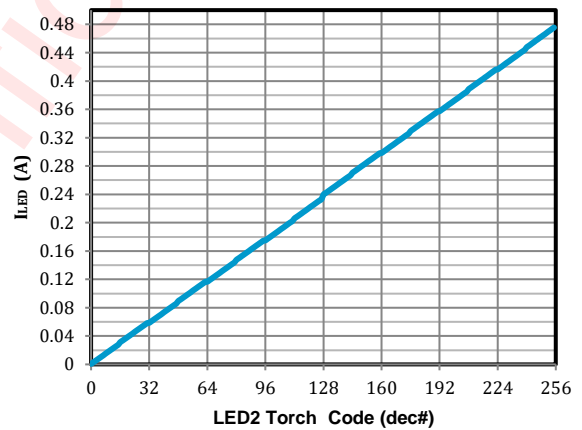

LED2 Torch Current vs Brightness Code

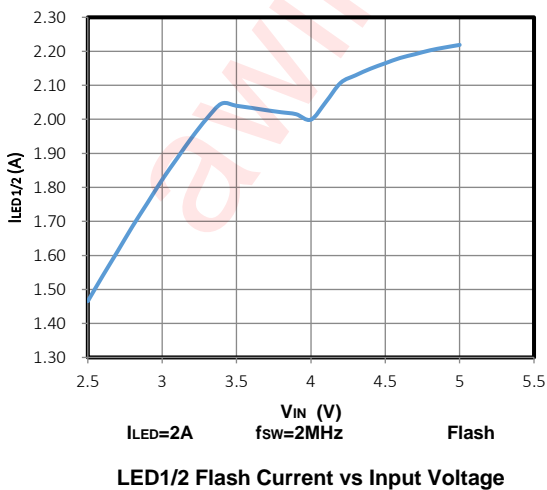

LED1/2 Flash Current vs Input Voltage

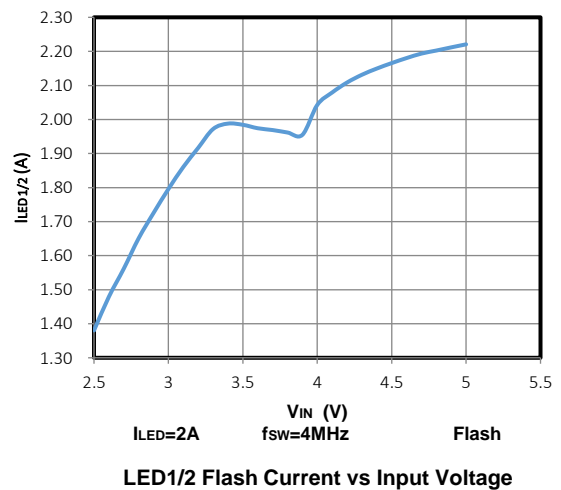

LED1/2 Flash Current vs Input Voltage

Ambient temperature is 25°C, input voltage is 3.6 V, $C_{IN} = C_{OUT} = 10 \mu F$ and $L=1 \mu H$, unless otherwise noted .

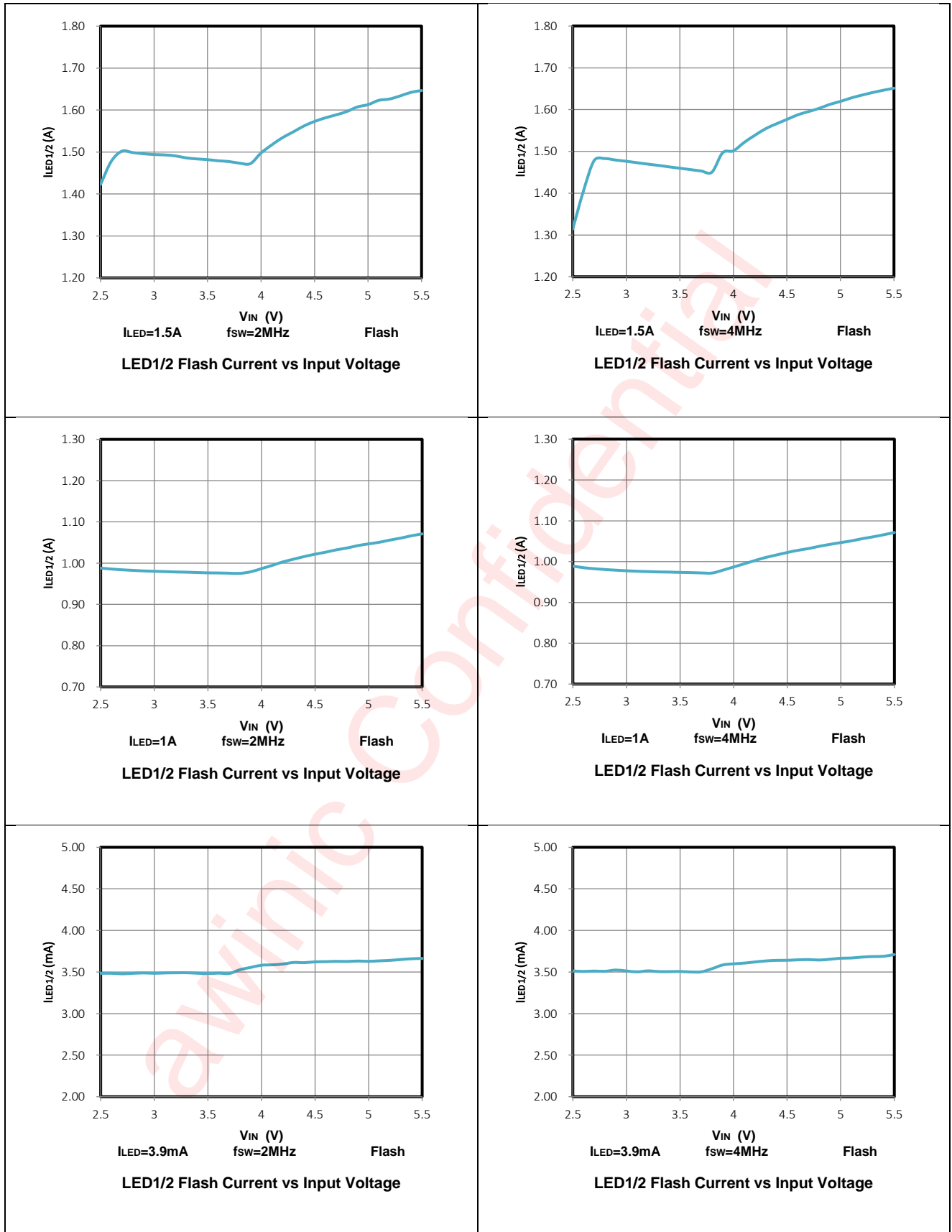

Ambient temperature is 25°C, input voltage is 3.6 V, CIN = COUT = 10 μF and L=1 μH, unless otherwise noted .

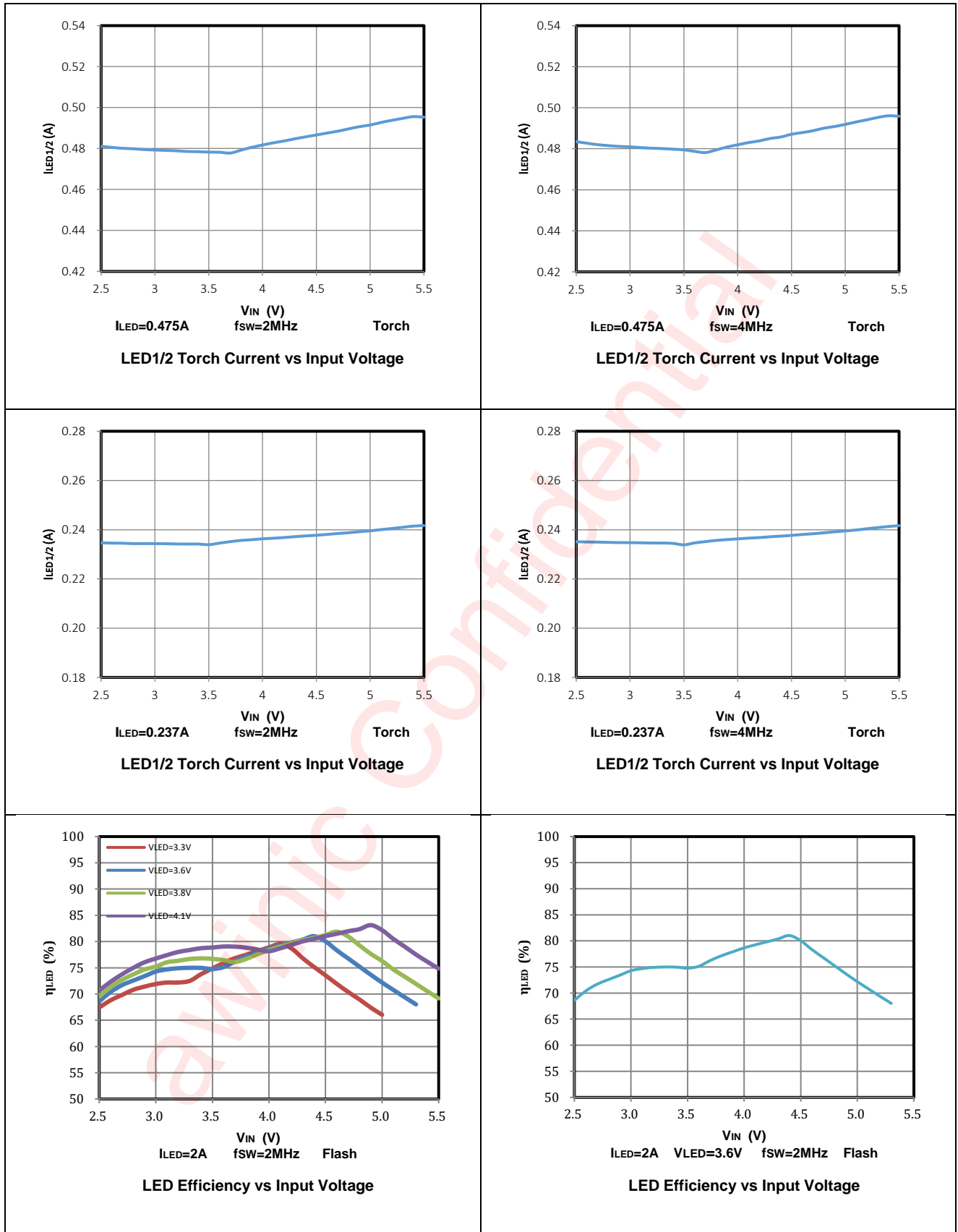

Ambient temperature is 25°C, input voltage is 3.6 V, CIN = COUT =10 μF and L=1 μH, unless otherwise noted .

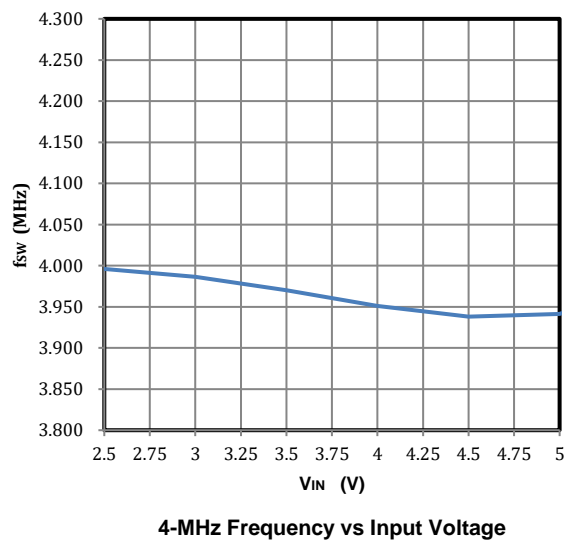
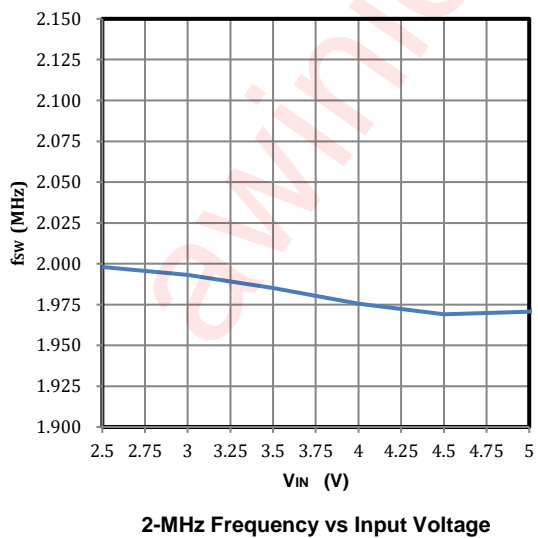
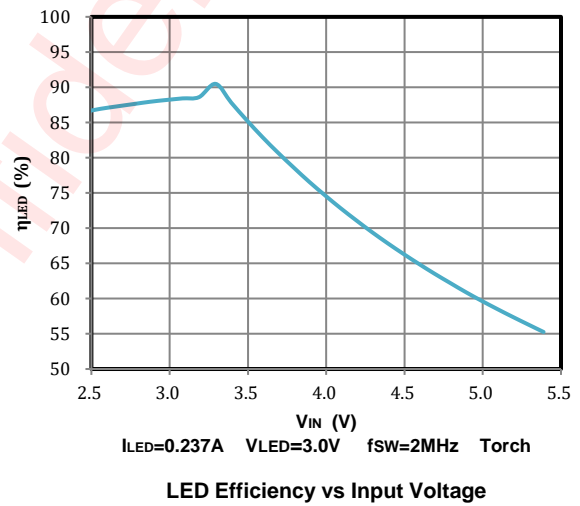
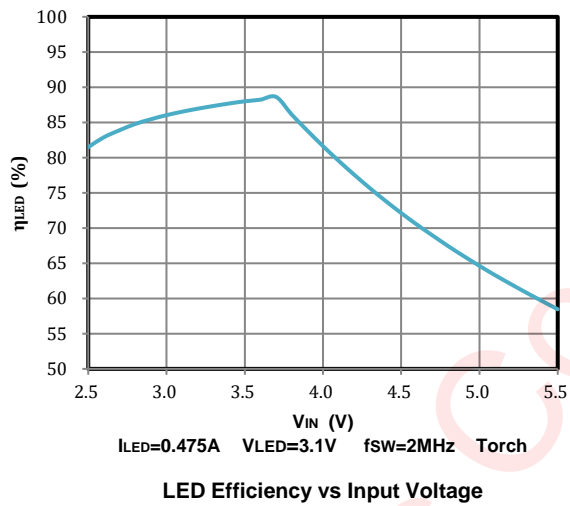
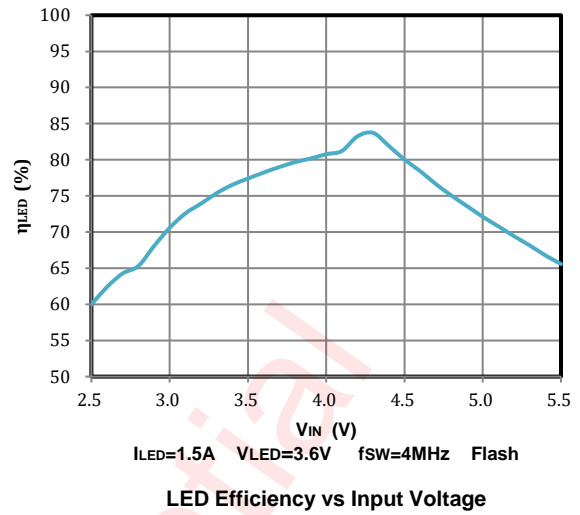
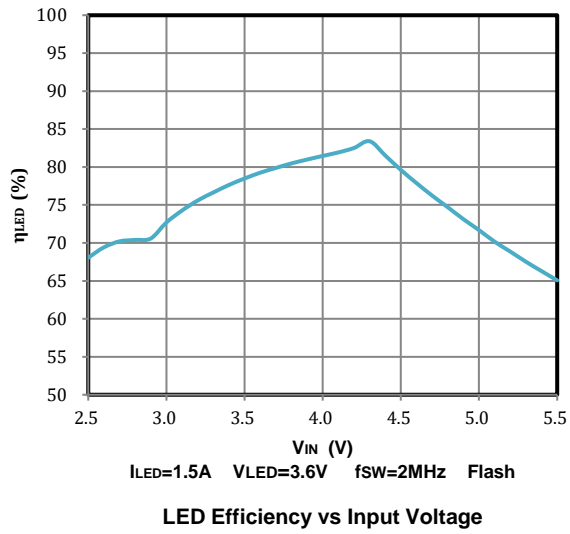

Ambient temperature is 25°C, input voltage is 3.6 V, CIN = COUT = 10 μF and L=1 μH, unless otherwise noted .

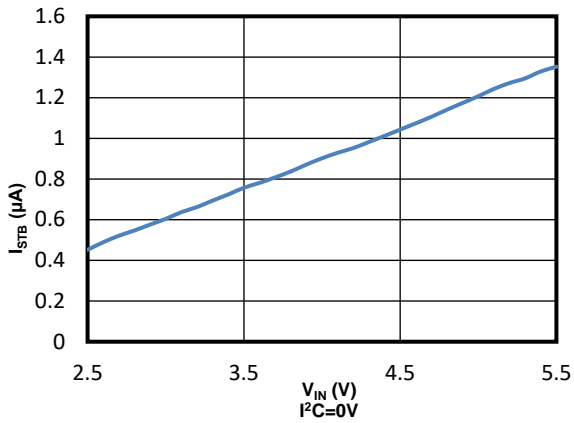

Standby Current vs Input Voltage

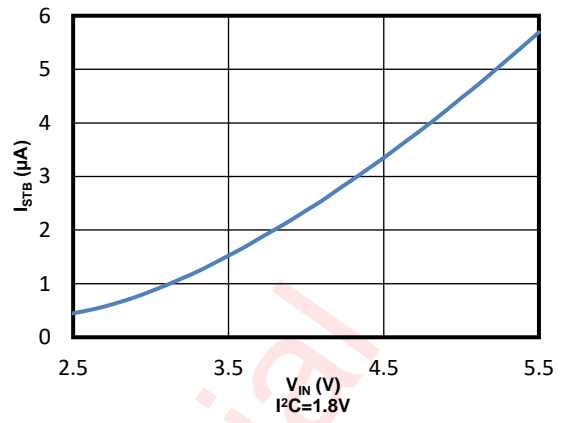

Standby Current vs Input Voltage

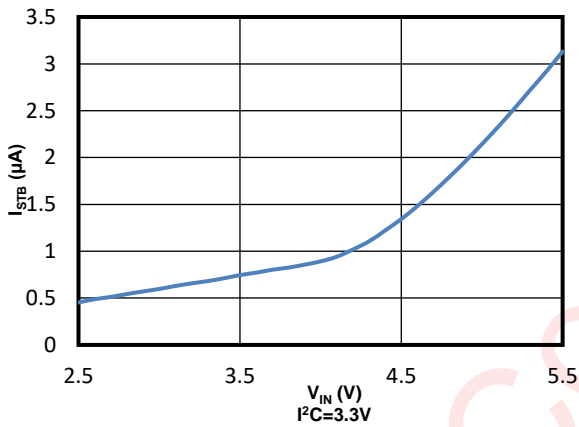

Standby Current vs Input Voltage

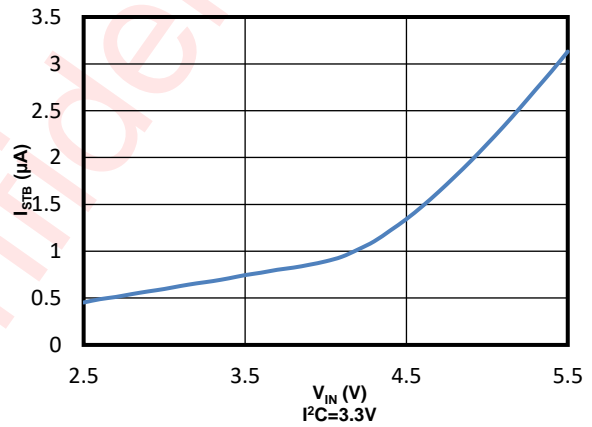

Standby Current vs Input Voltage

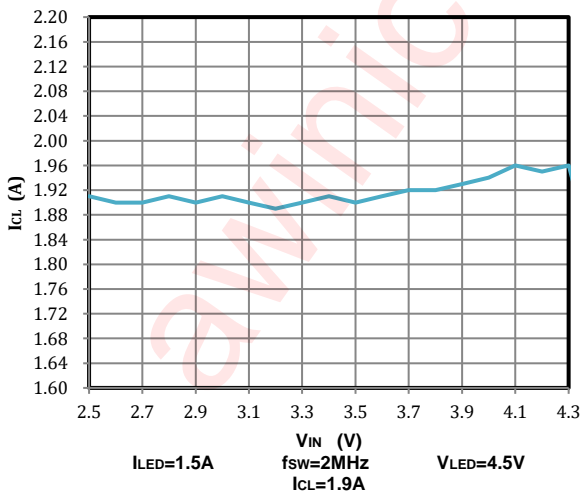

Inductor Current Limit vs Input Voltage

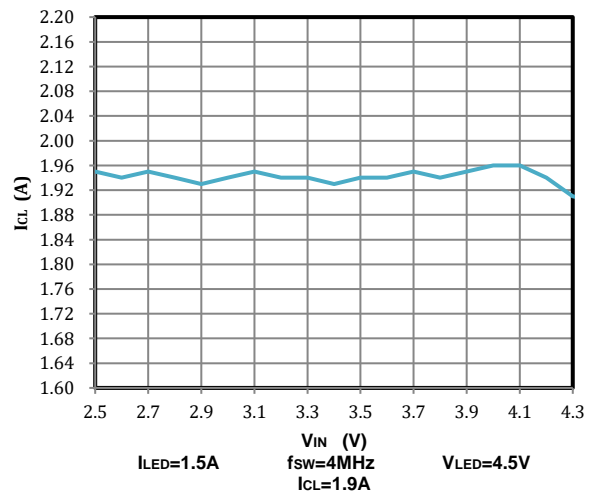

Inductor Current Limit vs Input Voltage

Ambient temperature is 25°C, input voltage is 3.6 V, $C_{IN} = C_{OUT} = 2 \times 10 \mu\text{F}$ and $L=1 \mu\text{H}$, unless otherwise noted .

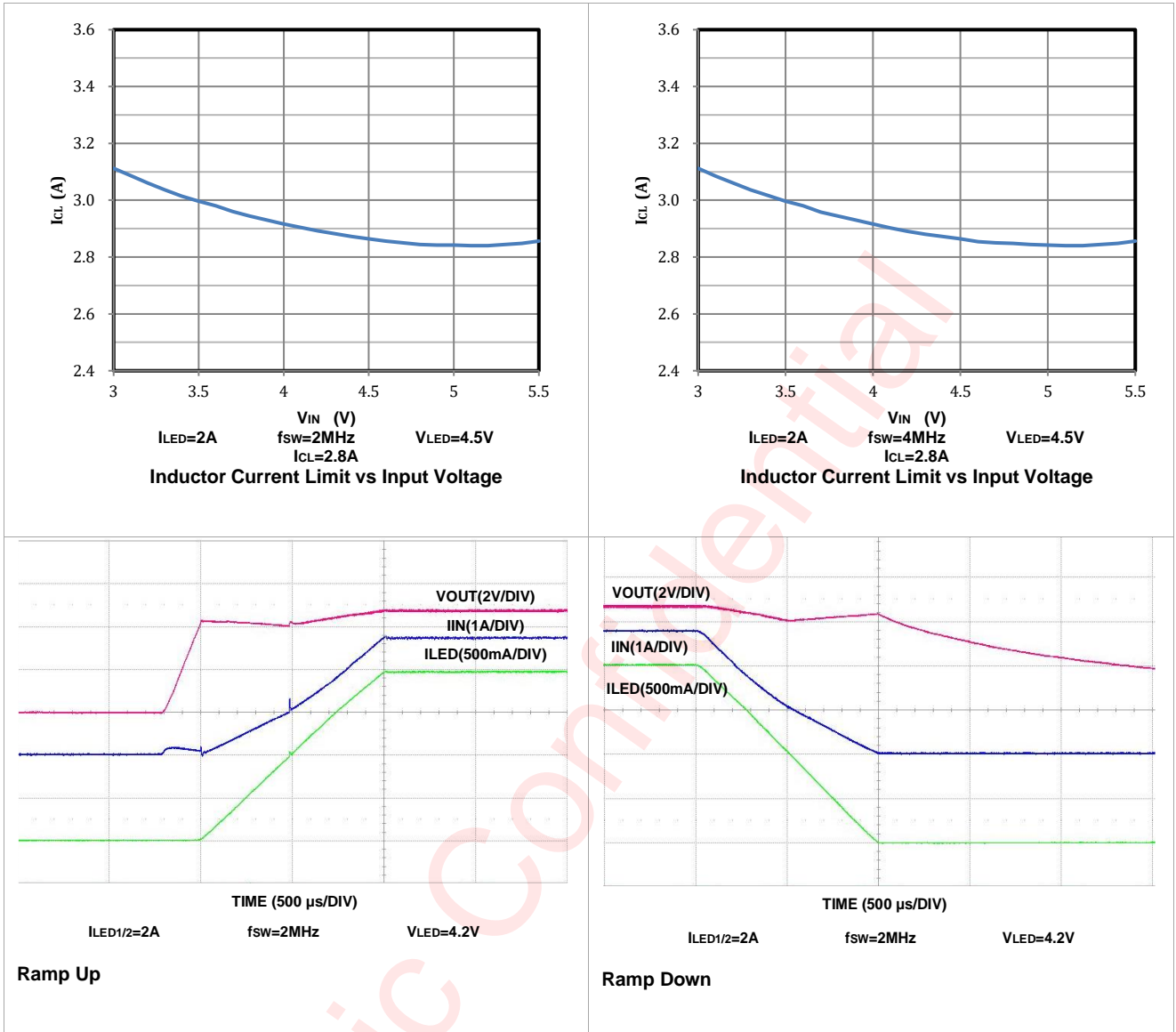

Detailed Functional Description

The AW36515A is a high-power LED flash driver capable of delivering up to 2A in either of the two parallel LEDs. The device incorporates a 2MHz or 4MHz constant frequency-synchronous current-mode PWM boost converter and dual high-side current sources to regulate the LED current over the 2.7V to 5.5V input voltage range.

The AW36515A PWM DC-DC boost converter switches and boosts the output to maintain at least V_{HR} across each of the current sources (LED1/2). This minimum headroom voltage ensures that both current sources remain in regulation. If the input voltage is above the LED voltage + current source headroom voltage, the device would not switch, but turn the PMOS on continuously (Pass mode). In Pass mode the difference between $(V_{IN} - I_{LED} \times R_{PMOS})$ and the voltage across the LED is dropped across the current source.

The AW36515A has two logic inputs including a reusable hardware Flash/Torch Enable (STROBE/TORCH) and a Flash Interrupt input (TX) designed to interrupt the flash pulse during high battery-current conditions. These logic inputs have internal 300k Ω (typical) pull-down resistors to GND.

Control is done via an I²C-compatible interface. This includes adjustment of the Flash and Torch current levels, changing the Flash Timeout Duration, and changing the switch current limit. Additionally, there are flag and status bits that indicate flash current timeout, LED over-temperature condition, LED failure (open/short), device thermal shutdown, TX interrupt, and V_{IN} under-voltage conditions.

Features Description

Power On Reset

When the supply voltage V_{IN} drops below a predefined voltage V_{POR} (2.0V typical), the device generates a reset signal to perform a power-on reset operation, which will reset all control circuits and configuration registers.

Once V_{IN} goes above around V_{POR} (2.0V typical), it should stay high for at least 2ms time before any I²C command can be accepted.

Software Reset

By setting bit[7](Software Reset Bit) to a '1' in the Boost Configuration Register(0x07) via I²C interface will reset the AW36515A internal circuit and all configuration registers, after the soft reset command is input through I²C, it needs to wait at least 2ms before any other I²C command can be accepted.

Flash Mode

In Flash Mode, the LED current sources (LED1/2) provide 256 target current levels from 3.91mA to 2A. The Flash currents are adjusted via the LED1 and LED2 Flash Brightness Registers. Flash mode is activated by the Enable Register(setting M1, M0 to '11'), or by pulling the STROBE/TORCH pin HIGH when bit[5] (Strobe Enable Bit) is '1' in the Enable Register(0x01). Once the Flash sequence is activated the current source (LED1/2) ramps up to the programmed Flash current by stepping through all current steps until the programmed current is reached.

When the device is enabled in Flash Mode through the Enable Register, all mode bits in the Enable Register are cleared after a flash timeout event.

Torch Mode

In Torch mode, the LED current sources (LED1/2) provide 256 target current levels from 0.93mA to 475mA on AW36515A. The Torch currents are adjusted via the LED1 and LED2 Torch Brightness Registers. Torch mode is activated by the Enable Register (setting M1, M0 to '10'), or by pulling the STROBE/TORCH pin HIGH when

bit[4] (Torch Enable Bit) is '1' in the Enable Register(0x01) and set to Standby Mode. Once the TORCH sequence is activated the active current sources (LED1/2) ramps up to the programmed Torch current by stepping through all current steps until the programmed current is reached. The rate at which the current ramps is determined by the value chosen in the Timing Register.

AW36515A will execute flash operation when both bit[4] and bit[5] are '1' in the Enable Register with pulling the STROBE/TORCH pin HIGH.

Torch Mode is not affected by Flash Timeout or by a TX Interrupt event.

IR Mode

In IR Mode, Enable register bit[3:2] should be to '01' (setting M1, M0 to '01') and the STROBE/TORCH pin should be enabled(Strobe Enable Bit). The target LED current is equal to the value stored in the LED1/2 Flash Brightness Registers. When IR mode is enabled, the boost converter turns on and set the output equal to the input (pass-mode) . The STROBE/TORCH pin can only be set to be Level sensitive, meaning all timing of the IR pulse is externally controlled, but it is still protected by flash time-out if STROBE width is too long. In IR Mode, the current sources do not ramp the LED outputs to the target. LED1/2 is enabled to the full current setting without delay or slow ramp during STROBE rising edge, and they are fully turned off immediately without delay or slow ramp during STROBE falling edge

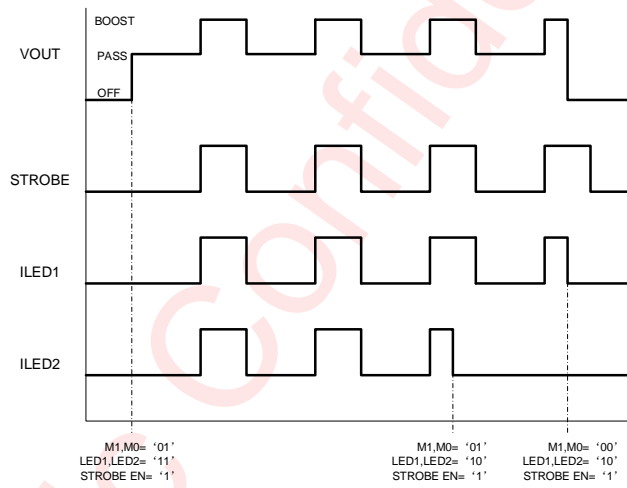

IR Mode with Boost

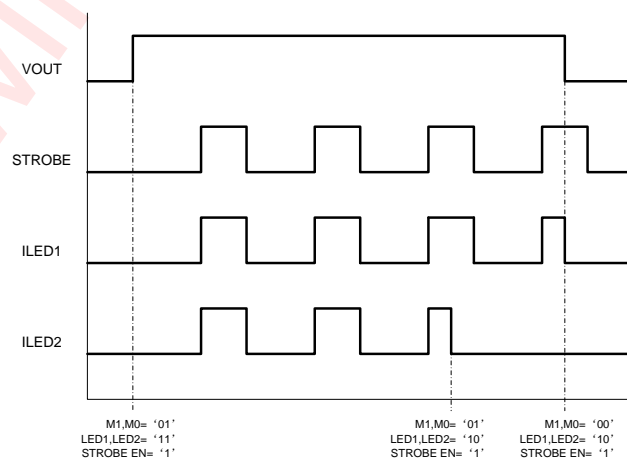

IR Mode Pass Only

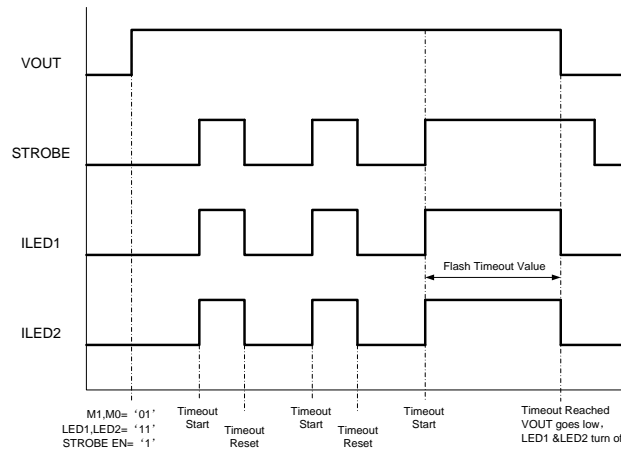

IR Mode Timeout

Soft Start-up

Turn on the AW36515A Torch and Flash modes can be done through the Enable Register. On start-up, when V_{OUT} is less than V_{IN} the internal synchronous PMOS turns on as a current source and delivers 200mA (typical) to the output capacitor. During this time the current source (LED) is off. When the voltage across the output capacitor reaches 2.3 V (typical) the current source turns on. At turn-on the current source steps through each FLASH or TORCH level until the target LED current is reached. This gives the device a controlled turn-on and limits inrush current from the V_{IN} supply.

Pass Mode

The AW36515A starts up in Pass Mode and stays there until Boost Mode is needed to maintain regulation. In Pass Mode the boost converter does not switch, and the synchronous PMOS turns fully on bringing V_{OUT} up to $V_{IN} - I_{LED} \times R_{PMOS}$. In Pass Mode the inductor current is not limited by the peak current limit. If the voltage difference between V_{OUT} and V_{LED} falls below V_{HR} , the device switches to Boost Mode.

AW36515A can be forced into pass mode only state regardless the V_{HR} , which must be set before system enter Boost mode, once system enter Boost mode, the bit2 of Boost Configuration Register (0x07) is invalid unless setting the device enter standby mode, or by setting the SW RESET bit to a '1', or by removing power to the AW36515A.

Power Amplifier Synchronization (TX)

The TX pin is a Power Amplifier Synchronization input. This is designed to reduce the flash LED current and thus limit the battery current during high battery current conditions such as PA transmit events. When the AW36515A is engaged in a Flash event, and the TX pin is pulled high, the LED current is forced into Torch Mode at the programmed Torch current setting. If the TX pin is then pulled low before the Flash pulse terminates, the LED current returns to the previous Flash current level. At the end of the Flash time-out, whether the TX pin is high or low, the LED current turns off.

The TX input can be disable by setting bit[7] (TX Enable) to a '0' in the Enable Register(0x01).

Input Voltage Flash Monitor (IVFM)

The AW36515A has the ability to adjust the flash current based upon the voltage level present at the IN pin utilizing the Input Voltage Flash Monitor (IVFM). The adjustable threshold ranges from 2.9 V to 3.6 V in 100mV steps as well as adjustable hysteresis, with Stop-and-Hold mode. The IVFM threshold and hysteresis are controlled by bits[5:3] and bit[2] respectively, in the IVFM Register(0x02). The Flags2 Register has the IVFM

flag bit set when the input voltage crosses the IVFM threshold value. Additionally, the IVFM threshold sets the input voltage boundary that forces the AW36515A to either stop ramping the flash current during startup in Stop and Hold Mode.

- Stop and Hold Mode: Stops Current Ramp and holds the level for the remaining flash, If V_{IN} falls below the IVFM threshold value.

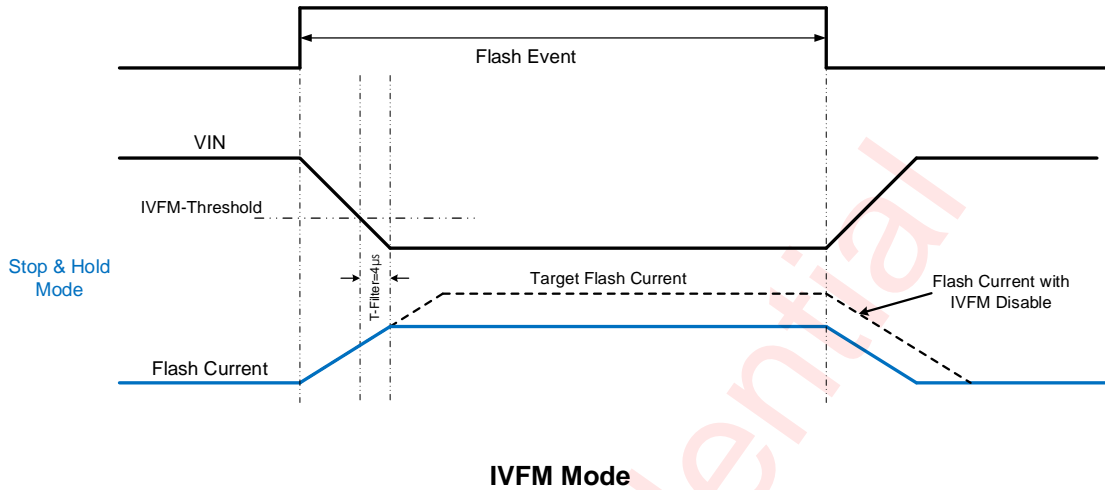

Flash Timeout

The Flash Timeout period sets the maximum time of one flash event, whether a flash stop command is received or not. The AW36515A has 16 timeout levels ranging from 40ms to 1.6s (see **TIMING CONFIGURATION REGISTER (0x08)** for more detail). Flash Timeout applies to both Flash and IR modes, and it continues to count when the Flash mode is forced into Torch mode during a TX high event. The mode bits are cleared and bit[0] is set in the Flags1 register(0x0A) upon a Flash Timeout. This fault flag can be reset to '0' by reading back the Flags1 Register (0x0A), 'or by setting the SW RESET bit to a '1', or by removing power to the AW36515A.

Current Limit

When the inductor current limit is reached, the AW36515A terminates the charging phase of the switching cycle until the next switching period. If the over-current condition persists, the device operates continuously in current limit. The AW36515A features two selectable inductor current limits(1.9A and 2.8A) that are programmable by bit[0] in Boost configuration Register(0x07).

Since the current limit is sensed in the NMOS switch, there is no mechanism to limit the current when the device operates in Pass Mode (current does not flow through the NMOS in pass mode). The mode bits are not cleared upon a Current Limit event, but a flag bit[3] is set in the Flags1 register(0x0A).

This fault flag can be reset to '0' by reading back the Flags1 Register (0x0A), or by setting the SW RESET bit to a '1', or by removing power to the AW36515A.

Undervoltage Lockout (UVLO)

The AW36515A has an internal comparator that monitors the voltage at IN and forces the AW36515A into standby if the input voltage drops to 2.5 V. If the UVLO monitor threshold is tripped, the UVLO flag bit is set in the Flags1 Register (0x0A). If the input voltage rises above 2.6 V, the AW36515A is not available for operation until there is an I²C read of the Flags1 Register (0x0A). Upon a read, the Flags1 register is cleared, and normal operation can resume if the input voltage is greater than 2.6 V.

VOUT Short Fault

The Output Short Fault flag reads back a '1' if the device is active in Flash or Torch mode and the boost output experiences a short condition. VOUT short condition occurs if the voltage at OUT goes below 2.2V (typ.) while the device is in Torch or Flash mode. There is a deglitch time of 2.048ms before the VOUT Short flag is valid. The mode bits are cleared upon an the VOUT short fault. The AW36515A is not available for operation until VOUT Fault flags is cleared. The VOUT Short Fault can be reset to '0' by reading back the Flags1 Register (0x0A), or by setting the SW RESET bit to a '1', or by removing power to the AW36515A.

LED Short Fault

The LED Short Fault flags read back a '1' if the device is active in Flash or Torch mode and either active LED output experiences a short condition. An LED short condition is determined if the voltage at LED1 or LED2 goes below 500mV (typ.) while the device is in Torch or Flash mode. There is a deglitch time of 256 μ s before the LED Short Fault flag is valid. The mode bits are cleared upon an LED Short Fault. The AW36515A is not available for operation until the LED Short Fault flags is cleared. The LED Short Faults can be reset to '0' by reading back the Flags1 Register (0x0A), or by setting the SW RESET bit to a '1', or by removing power to the AW36515A.

Overvoltage Protection (OVP)

The output voltage is limited to typically 5 V. In situations such as an open LED, the AW36515A raises the output voltage in order to try and keep the LED current at its target value. When VOUT reaches 5 V (typ.) the overvoltage comparator trips and turns off the internal NMOS. When VOUT falls below the "V_{OVP} Off Threshold", the AW36515A begins switching again. The mode bits are cleared, and the OVP Fault flag is set, when an OVP condition is present for three rising OVP edges. This prevents momentary OVP events from forcing the device to shut down. The AW36515A is not available for operation until the OVP Fault flag is cleared. The OVP Fault can be reset to '0' by reading back the Flags2 Register (0x0A), or by setting the SW RESET bit to a '1', or by removing power to the AW36515A. When the chip works in TX mode and TX pin is high, OVP fault will not be counted and triggered when the output voltage exceeds the OVP threshold.

Thermal Shutdown (TSD)

When the AW36515A die temperature reaches 155°C, the thermal shutdown detection circuit trips, forcing the AW36515A enter standby mode and writing a '1' to the Thermal Shutdown Fault flag of the Flags1 Register (0x0A) . The AW36515A is only allowed to restart after the Thermal Shutdown Fault flag is cleared. The Thermal Shutdown Faults can be reset to '0' by reading back the Flags1 Register (0x0A), or by setting the SW RESET bit to a '1', or by removing power to the AW36515A. Upon restart, if the die temperature is still above 155°C, the AW36515A resets the Fault flag and re-enters standby mode.

Programming

Control Truth Table

| MODE1 | MODE0 | STROBE EN | TORCH EN | STROBE/TORCH PIN | ACTION |
|-------|-------|-----------|----------|------------------|---------------|
| 0 | 0 | 0 | 0 | X | Standby |
| 0 | 0 | 0 | 1 | edge | Ext Torch |
| 0 | 0 | 1 | 0 | edge | Ext Flash |
| 0 | 0 | 1 | 1 | edge | Ext Flash |
| 1 | 0 | X | X | X | Int Torch |
| 1 | 1 | X | X | X | Int Flash |
| 0 | 1 | 0 | X | X | IRLED Standby |
| 0 | 1 | 1 | X | 0 | IRLED Standby |
| 0 | 1 | 1 | X | edge | IRLED Enabled |

I²C Interface

Data Validation

When SCL is high level, SDA level must be constant. SDA can be changed only when SCL is low level.

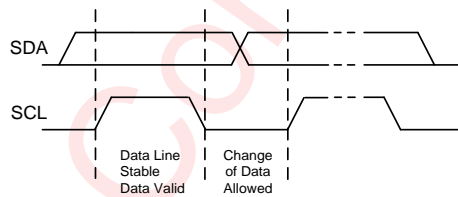

Data Validation Diagram

I²C Start/Stop

I²C start: SDA changes from high level to low level when SCL is high level.

I²C stop: SDA changes from low level to high level when SCL is high level.

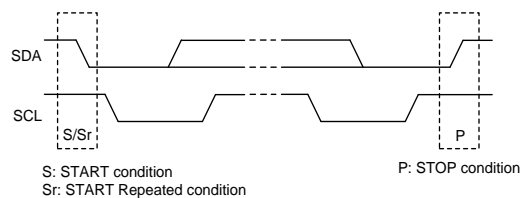

Start and Stop Conditions

ACK (Acknowledgement)

ACK means the successful transfer of I²C bus data. After master sends an 8-bit data, SDA must be released; SDA is pulled to GND by slave device when slave acknowledges.

When master reads, slave device sends 8-bit data, releases the SDA and waits for ACK from master. If ACK is sent and I²C stop is not sent by master, slave device sends the next data. If ACK is not sent by master, slave device stops to send data and waits for I²C stop.

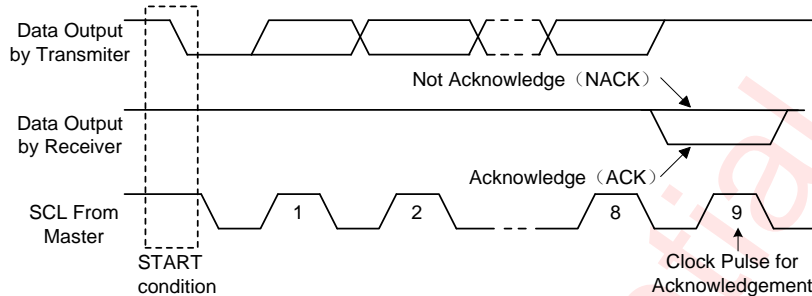

I2C ACK Timing

Write Cycle

One data bit is transferred during each clock pulse. Data is sampled during the high state of the serial clock (SCL). Consequently, throughout the clock's high period, the data should remain stable. Any changes on the SDA line during the high state of the SCL and in the middle of a transaction, aborts the current transaction. New data should be sent during the low SCL state. This protocol allows a single data line to transfer both command/control information and data using the synchronous serial clock.

Each data transaction is composed of a Start Condition, a number of byte transfers (set by the software) and a Stop Condition to terminate the transaction. Every byte written to the SDA bus must be 8 bits long and is transferred with the most significant bit first. After each byte, an Acknowledge signal must follow.

In a write process, the following steps should be followed:

- Master device generates START condition. The "START" signal is generated by lowering the SDA signal while the SCL signal is high.
- Master device sends slave address (7-bit) and the data direction bit (R/W = 0).
- Slave device sends acknowledge signal if the slave address is correct.
- Master sends control register address (8-bit)
- Slave sends acknowledge signal
- Master sends data byte to be written to the addressed register
- Slave sends acknowledge signal
- If master will send further data bytes the control register address will be incremented by one after acknowledge signal (repeat step f and g)
- Master generates STOP condition to indicate write cycle end

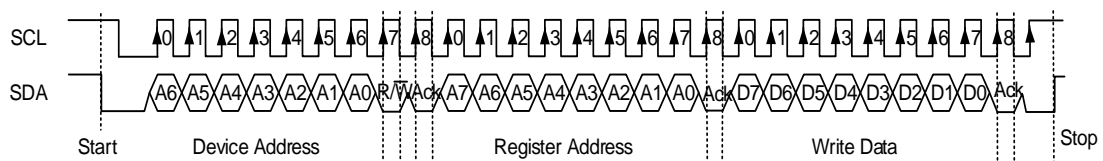

I²C Write Timing

Read Cycle

In a read cycle, the following steps should be followed:

- a) Master device generates START condition.
- b) Master device sends slave address (7-bit) and the data direction bit (R/W = 0).
- c) Slave device sends acknowledge signal if the slave address is correct.
- d) Master sends control register address (8-bit).
- e) Slave sends acknowledge signal.
- f) Master generates STOP condition followed with START condition or REPEAT START condition.
- g) Master device sends slave address (7-bit) and the data direction bit (R/W = 1).
- h) Slave device sends acknowledge signal if the slave address is correct.
- i) Slave sends data byte from addressed register.
- j) If the master device sends acknowledge signal, the slave device will increase the control register address by one, then send the next data from the new addressed register.
- k) If the master device generates STOP condition, the read cycle is ended.

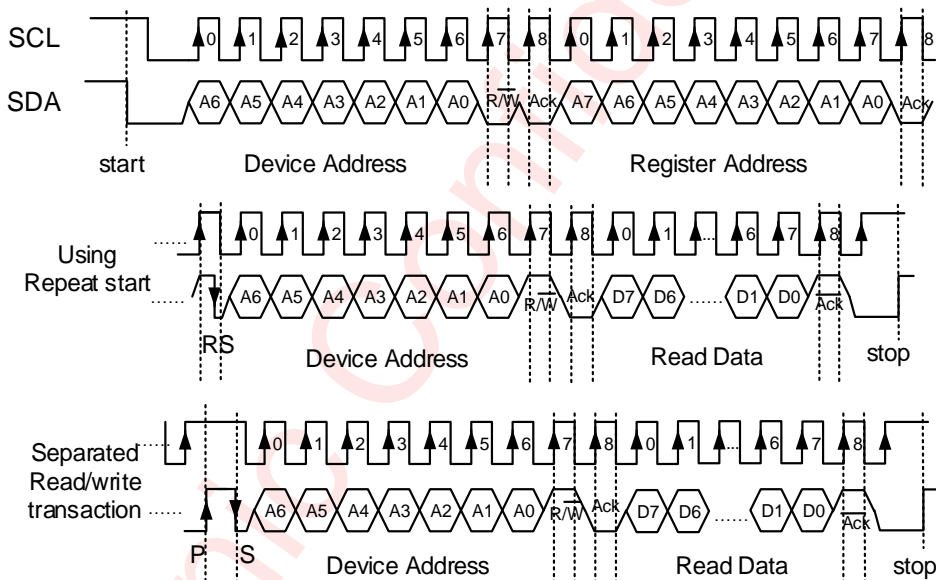

I²C Read Timing

Register Configuration

Register List

| Register name | Address(HEX) | Read/Write | Default Value |
|--------------------------------|--------------|------------|---------------|
| Chip ID Register | 0x00 | Read | 0x30 |
| Enable Register | 0x01 | Read/Write | 0x80 |
| IVFM Register | 0x02 | Read/Write | 0x01 |
| LED1 Flash Brightness Register | 0x03 | Read/Write | 0x7F |
| LED2 Flash Brightness Register | 0x04 | Read/Write | 0x7F |
| LED1 Torch Brightness Register | 0x05 | Read/Write | 0x7F |
| LED2 Torch Brightness Register | 0x06 | Read/Write | 0x7F |
| Boost Configuration Register | 0x07 | Read/Write | 0x09 |
| Timing Configuration Register | 0x08 | Read/Write | 0x1A |
| Flags1 Register | 0x0A | Read | 0x00 |
| Flags2 Register | 0x0B | Read | 0x00 |
| Device ID Register | 0x0C | Read | 0x02 |
| Last Flash Register | 0x0D | Read | 0x00 |
| Version ID Register | 0x25 | Read/Write | 0x84 |
| ADJ Register | 0x31 | Read/Write | 0x00 |
| WPRT Register | 0x69 | Read/Write | 0x00 |

Register Detailed Description

◇ Chip ID Register (0x00)

| Bit 7 | Bit 6 | Bit 5 | Bit 4 | Bit 3 | Bit 2 | Bit 1 | Bit 0 |
|---------------------|-------|-------|-------|-------|-------|-------|-------|
| Chip ID: "00110000" | | | | | | | |

◇ Enable Register (0x01)

| Bit 7 | Bit 6 | Bit 5 | Bit 4 | Bit 3 | Bit 2 | Bit 1 | Bit 0 |
|--|--|--|---|---|-------|--|--|
| TX Pin Enable 0=Disabled 1=Enabled (Default) | Strobe Type 0=Level Triggered (Default) 1=Edge Triggered | Strobe Enable 0=Disabled (Default) 1=Enabled | Torch Enable 0=Disabled (Default) 1=Enabled | Mode Bits: M1, M0 00=Standby (Default) 01=IR Drive 10=Torch 11=Flash | | LED2 Enable 0=OFF (Default) 1=ON | LED1 Enable 0=OFF (Default) 1=ON |

Note:

In Edge or Level Strobe Mode, it is recommended that the trigger pulse width be set greater than 1ms to ensure proper turn-on of the device. The edge trigger mode applied to the flash, the strobe must have an ascending edge and light up the LED on the falling edge.

◇ **IVFM Register (0x02)**

| Bit 7 | Bit 6 | Bit 5 | Bit 4 | Bit 3 | Bit 2 | Bit 1 | Bit 0 |
|-------|---|---|-------|-------|-------|-------|---|
| RFU | UVLO Circuitry 0=Disabled (Default) 1=Enabled | IVFM Levels 000=2.9 V (Default) 001=3.0 V 010=3.1 V 011=3.2 V 100=3.3 V 101=3.4 V 110=3.5 V 111=3.6 V | | | RFU | RFU | IVFM Enable 0=Disabled 1=Enabled (Default) |

◇ **LED1 Flash Brightness Register (0x03)**

| Bit 7 | Bit 6 | Bit 5 | Bit 4 | Bit 3 | Bit 2 | Bit 1 | Bit 0 |
|---|-------|-------|-------|-------|-------|-------|-------|
| LED1 Flash Brightness Levels $I_{FLASH}(mA) \approx (Brightness\ Code * 7.83mA) + 3.91mA$ 00000000=3.91 mA 01111111=998.32 mA (Default) 11111111=2.0 A | | | | | | | |

◇ **LED2 Flash Brightness Register (0x04)**

| Bit 7 | Bit 6 | Bit 5 | Bit 4 | Bit 3 | Bit 2 | Bit 1 | Bit 0 |
|---|-------|-------|-------|-------|-------|-------|-------|
| LED2 Flash Brightness Levels $I_{FLASH}(mA) \approx (Brightness\ Code * 7.83mA) + 3.91mA$ 00000000=3.91 mA 01111111=998.32 mA (Default) 11111111=2.0 A | | | | | | | |

◇ **LED1 Torch Brightness Register (0x05)**

| Bit 7 | Bit 6 | Bit 5 | Bit 4 | Bit 3 | Bit 2 | Bit 1 | Bit 0 |
|---|-------|-------|-------|-------|-------|-------|-------|
| LED1 Torch Brightness Levels $I_{TORCH}(mA) \approx (Brightness\ Code * 1.86mA) + 0.93mA$ 00000000=0.93 mA 01111111=237 mA (Default) 11111111=475 mA | | | | | | | |

◇ **LED2 Torch Brightness Register (0x06)**

| Bit 7 | Bit 6 | Bit 5 | Bit 4 | Bit 3 | Bit 2 | Bit 1 | Bit 0 |
|---|-------|-------|-------|-------|-------|-------|-------|
| LED2 Torch Brightness Levels $I_{TORCH}(mA) \approx (Brightness\ Code * 1.86mA) + 0.93mA$ 00000000=0.93 mA 01111111=237 mA (Default) 11111111=475 mA | | | | | | | |

◇ Boost Configuration Register (0x07)

| Bit 7 | Bit 6 | Bit 5 | Bit 4 | Bit 3 | Bit 2 | Bit 1 | Bit 0 |
|--|-------|-------|-------|---|--|--|---|
| Software Reset Bit 0=Not Reset (Default) 1=Reset | RFU | RFU | RFU | LED Pin Short Fault Detect 0=Disabled 1=Enabled (Default) | Boost Mode 0=Normal (Default) 1=Pass Mode Only | Boost Frequency Select 0=2 MHz (Default) 1=4 MHz | Boost Current Limit 0=1.9A 1=2.8A (Default) |

◇ Timing Configuration Register (0x08)

| Bit 7 | Bit 6 | Bit 5 | Bit 4 | Bit 3 | Bit 2 | Bit 1 | Bit 0 |
|-------|---|-------|-------|---|-------|-------|-------|
| RFU | Torch Current Ramp time 000=No Ramp 001=1 ms (Default) 010=32 ms 011=64 ms 100=128 ms 101=256 ms 110=512 ms 111=1024 ms | | | Flash Time-out Duration 0000=40 ms 0001=80 ms 0010=120 ms 0011=160 ms 0100=200 ms 0101=240 ms 0110=280 ms 0111=320 ms 1000=360 ms 1001=400 ms 1010=600 ms (Default) 1011=800 ms 1100=1000 ms 1101=1200 ms 1110=1400 ms 1111=1600 ms | | | |

◇ Flags1 Register (0x0A)

| Bit 7 | Bit 6 | Bit 5 | Bit 4 | Bit 3 | Bit 2 | Bit 1 | Bit 0 |
|---------|------------------------------|------------------|------------------|--------------------|------------------------------|------------|---------------------|
| TX Flag | V _{OUT} Short Fault | LED1 Short Fault | LED2 Short Fault | Current Limit Flag | Thermal Shutdown (TSD) Fault | UVLO Fault | Flash Time-Out Flag |

◇ Flags2 Register (0x0B)

| Bit 7 | Bit 6 | Bit 5 | Bit 4 | Bit 3 | Bit 2 | Bit 1 | Bit 0 |
|-------|-------|-------|-------|-------|----------------|-----------|-------|
| RFU | RFU | RFU | RFU | RFU | IVFM Trip Flag | OVP Fault | RFU |

◇ Device ID Register (0x0C)

| Bit 7 | Bit 6 | Bit 5 | Bit 4 | Bit 3 | Bit 2 | Bit 1 | Bit 0 |
|-------|-------|-------|-------------------|--------------------------------|-------|-------|-------|
| RFU | RFU | RFU | Device ID "00" | Silicon Revision Bits "010" | | | |

◇ Last Flash Register (0x0D)

| Bit 7 | Bit 6 | Bit 5 | Bit 4 | Bit 3 | Bit 2 | Bit 1 | Bit 0 |
|-------|--|-------|-------|-------|-------|-------|-------|
| RFU | The value stored is always the last current value the IVFM detection block set ILED=IFLASH-TARGET*((code+1)/256) | | | | | | |

◇ **Version Register (0x25)**

| Bit 7 | Bit 6 | Bit 5 | Bit 4 | Bit 3 | Bit 2 | Bit 1 | Bit 0 |
|-------|-------|-------|-------|-------|-------|-------|-------|
| 1 | RFU | RFU | RFU | RFU | 1 | 0 | 0 |

◇ **ADJ Register (0x31)**

| Bit 7 | Bit 6 | Bit 5 | Bit 4 | Bit 3 | Bit 2 | Bit 1 | Bit 0 |
|-------|-------|-------|-------|---|-------|-------|-------|
| RFU | RFU | RFU | RFU | ADJ_OCP_DEL 00=23.2ns 01=26.3ns 10=30.7ns 11=41.4ns | | RFU | RFU |

◇ **Last Flash Register (0x69)**

| Bit 7 | Bit 6 | Bit 5 | Bit 4 | Bit 3 | Bit 2 | Bit 1 | Bit 0 |
|--|-------|-------|-------|-------|-------|-------|-------|
| WPRT : 0x69=0x02:close write protection and allow writing value to hide register 0x31. | | | | | | | |

Application Information

The AW36515A can drive two flash LEDs at currents up to 2 A per LED. The 2MHz/4MHz DC-DC boost regulator allows for the use of small value discrete external components. Below are some peripheral selection guidelines.

Output Capacitor Selection

The AW36515A is designed to operate with a 10μF ceramic output capacitor. When the boost converter is running, the output capacitor supplies the load current during the boost converter on-time. When the NMOS switch turns off, the inductor energy is discharged through the internal PMOS switch, supplying power to the load and restoring charge to the output capacitor. This causes a sag in the output voltage during the on-time and a rise in the output voltage during the off-time. The output capacitor is therefore chosen to limit the output ripple to an acceptable level depending on load current and input/output voltage differentials and also to ensure the converter remains stable.

Larger capacitors such as a 22μF or capacitors in parallel can be used if lower output voltage ripple is desired. To estimate the output voltage ripple considering the ripple due to capacitor discharge (ΔV_Q) and the ripple due to the capacitors ESR (ΔV_{ESR}) use the following equations:

For continuous conduction mode, the output voltage ripple due to the capacitor discharge is:

$$\Delta V_Q = \frac{(V_{OUT} - V_{IN}) \times I_{LED}}{V_{OUT} \times f \times C_{OUT}}$$

The output voltage ripple due to the output capacitors ESR is found by:

$$\Delta V_{ESR} = R_{ESR} \times \left(\frac{V_{OUT} \times I_{LED}}{V_{IN}} + \frac{\Delta I_L}{2} \right) \quad \text{Where} \quad \Delta I_L = \frac{V_{IN} \times (V_{OUT} - V_{IN})}{V_{OUT} \times f \times L}$$

In ceramic capacitors the ESR is very low so the assumption is that 80% of the output voltage ripple is due to capacitor discharge and 20% from ESR. Table 1 lists different manufacturers for various output capacitors and their case sizes suitable for use with the AW36515A.

Input Capacitor Selection

Choosing the correct size and type of input capacitor helps minimize the voltage ripple caused by the switching of the AW36515A boost converter and reduce noise on the boost converter's input pin that can feed through and disrupt internal analog signals. In the typical application circuit a 10-μF ceramic input capacitor works well. It is important to place the input capacitor as close as possible to the AW36515A input (IN) pin. This reduces the series resistance and inductance that can inject noise into the device due to the input switching currents. Table 1 lists various input capacitors recommended for use with the AW36515A.

Table 1 Recommended Input/ Output Capacitors (X5R/X7R Dielectric)

| MANUFACTURER | PART NUMBER | VALUE | CASE | VOLTAGE RATING |
|--------------|-------------------|-------|------|----------------|
| TDK | C1608JB0J106M | 10μF | 0603 | 6.3V |
| TDK | C2012JB1A106M | 10μF | 0805 | 10V |
| Murata | GRM188R60J106M | 10μF | 0603 | 6.3V |
| Murata | GRM21BR61A106KE19 | 10μF | 0805 | 10V |

Inductor Selection

The AW36515A is designed to use a 0.47μH or 1μH inductor. When the device is boosting ($V_{OUT} > V_{IN}$) the inductor is typically the largest area of efficiency loss in the circuit. Therefore, choosing an inductor with the lowest possible series resistance is important. Additionally, the saturation rating of the inductor should be greater than the maximum operating peak current of the AW36515A. This prevents excess efficiency loss that can occur with inductors that operate in saturation. For proper inductor operation and circuit performance, ensure that the inductor saturation and the peak current limit setting of the AW36515A are greater than I_{PEAK} in the following calculation:

$$I_{PEAK} = \frac{I_{LED} \times V_{OUT}}{\eta \times V_{IN}} + \Delta I_L \quad \text{where} \quad \Delta I_L = \frac{V_{IN} \times (V_{OUT} - V_{IN})}{2 \times f_{SW} \times L \times V_{OUT}}$$

And $f_{SW} = 2$ or 4MHz.

Table 2 lists various inductors and their manufacturers that work well with the AW36515A.

Table 2 Recommended Inductors

| MANUFACTURER | L | PART NO. | SIZE | IsAT | R _{DC} |
|--------------|--------|------------------|--------------------------|------|-----------------|
| TOKO | 1μH | DFE201610P-1R0M | 2.0 mm x 1.6 mm x 1.0 mm | 3.7A | 58mΩ |
| TOKO | 0.47μH | DFE201610P-R470M | 2.0 mm x 1.6 mm x 1.0 mm | 4.1A | 32mΩ |
| Sunlord | 1μH | WPN252012H1R0MT | 2.5mm x 2.0mm x1.2mm | 3.4A | 48mΩ |

PCB Layout Consideration

Layout Guidelines

The high switching frequency and large switching currents of the AW36515A make the choice of layout important. The following steps should be used as a reference to ensure the device is stable and maintains proper LED current regulation across its intended operating voltage and current range.

1. Place C_{IN} on the top layer (same layer as the AW36515A) and as close to the device as possible. The input capacitor conducts the driver currents during the low-side MOSFET turn-on and turn-off and can detect current spikes over 2 A in amplitude. Connecting the input capacitor through short, wide traces to both the IN and GND pins reduces the inductive voltage spikes that occur during switching which can corrupt the V_{IN} line.
2. Place C_{OUT} on the top layer (same layer as the AW36515A) and as close as possible to the OUT and GND pin. The returns for both C_{IN} and C_{OUT} should come together at one point, as close to the GND pin as possible. Connecting C_{OUT} through short, wide traces reduce the series inductance on the OUT and GND pins that can corrupt the V_{OUT} and GND lines and cause excessive noise in the device and surrounding circuitry.
3. Connect the inductor on the top layer close to the SW pin. There should be a low-impedance connection from the inductor to SW due to the large DC inductor current, and at the same time the area occupied by the SW node should be small so as to reduce the capacitive coupling of the high dV/dT present at SW that can couple into nearby traces.
4. Avoid routing logic traces near the SW node so as to avoid any capacitive coupling from SW onto any high-impedance logic lines such as TX, STROBE/TORCH, SDA, and SCL. A good approach is to insert an inner layer GND plane underneath the SW node and between any nearby routed traces. This creates a shield from the electric field generated at SW.
5. Terminate the Flash LED cathodes directly to the GND pin of the AW36515A. If possible, route the LED returns with a dedicated path so as to keep the high amplitude LED currents out of the GND plane. For Flash LEDs that are routed relatively far away from the AW36515A, a good approach is to sandwich the forward and return current paths over the top of each other on two layers. This helps reduce the inductance of the LED current paths.

Tape and Reel Information

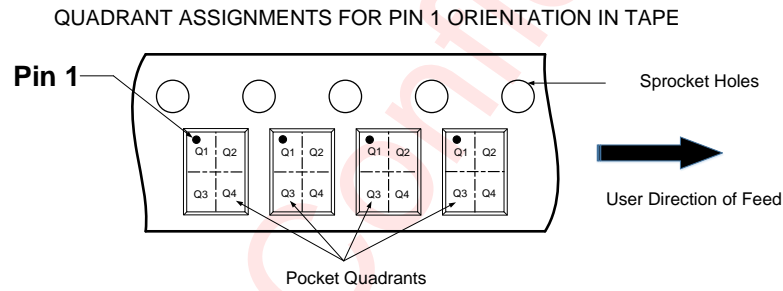
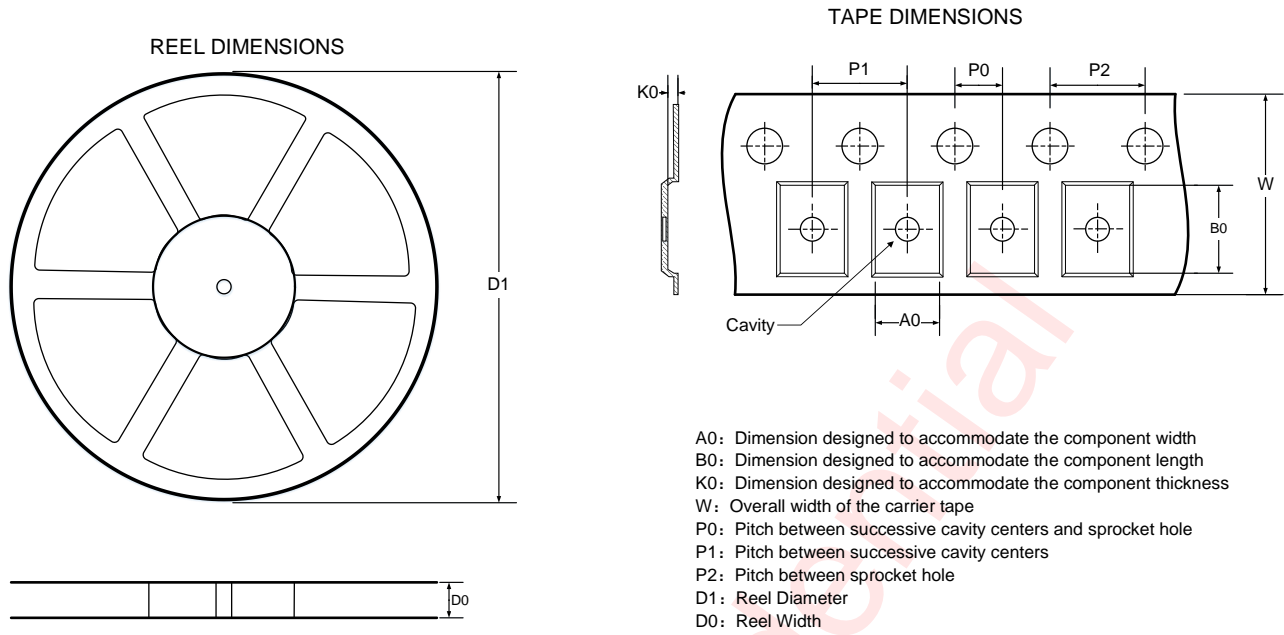

Note: The above picture is for reference only. Please refer to the value in the table below for the actual size

DIMENSIONS AND PIN1 ORIENTATION

| D1 (mm) | D0 (mm) | A0 (mm) | B0 (mm) | K0 (mm) | P0 (mm) | P1 (mm) | P2 (mm) | W (mm) | Pin1 Quadrant |
|---------|---------|---------|---------|---------|---------|---------|---------|--------|---------------|
| 178.0 | 8.40 | 1.35 | 1.75 | 0.70 | 2.00 | 4.00 | 4.00 | 8.00 | Q1 |

All dimensions are nominal

Package Description

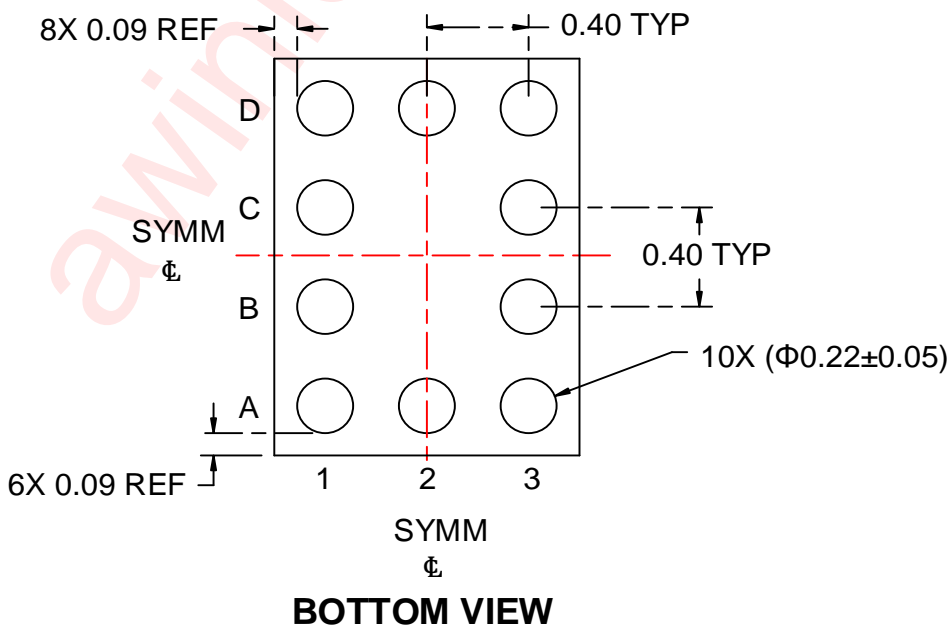
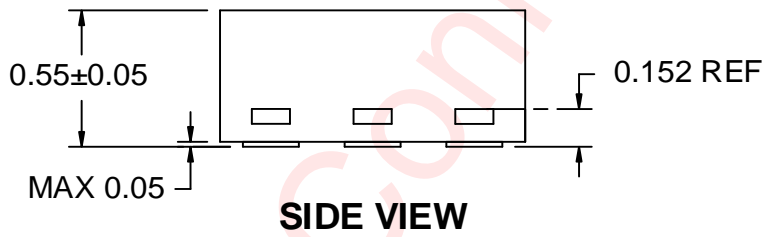
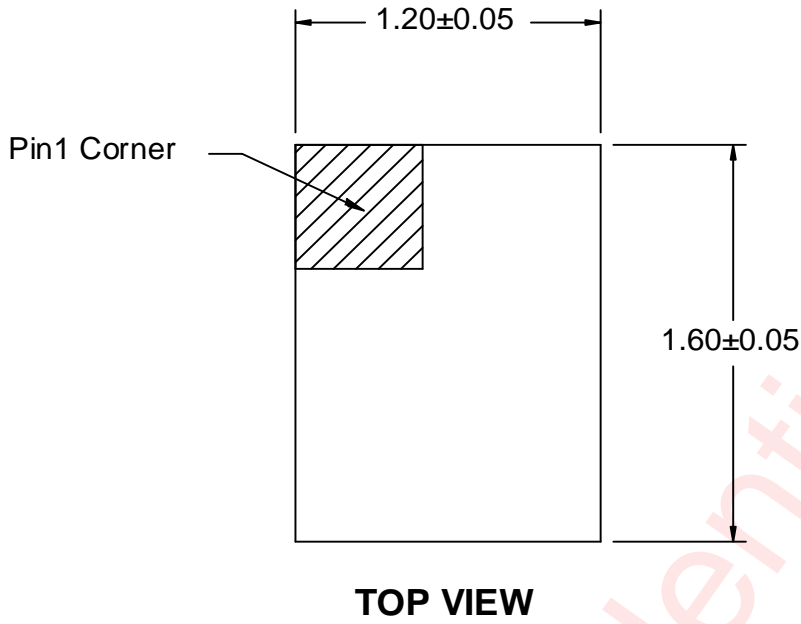

Unit:mm

Land Pattern Data

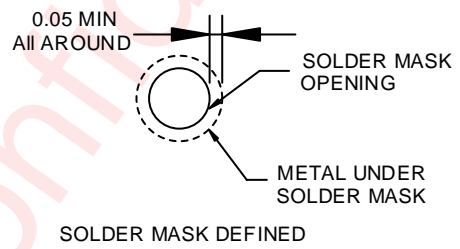
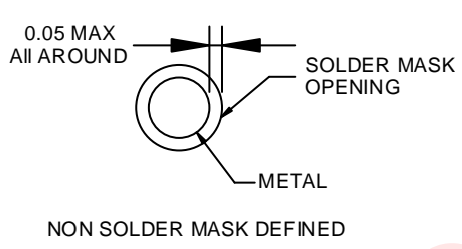
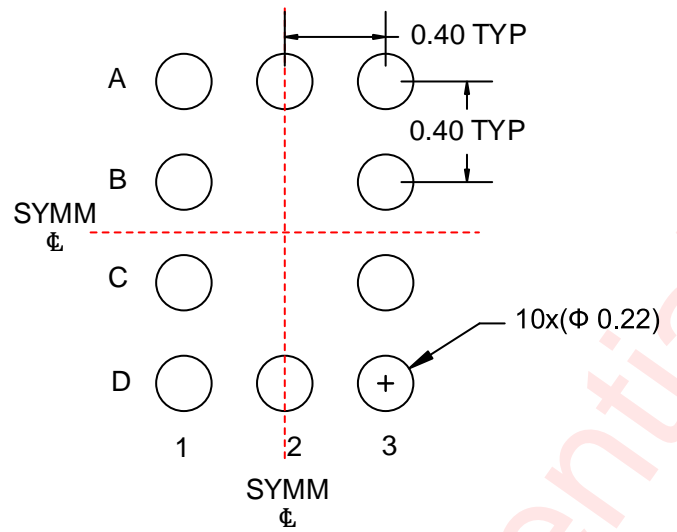

Unit: mm

Revision History

| Version | Date | Change Record |
|---------|-----------|---|
| V0.9 | Mar. 2022 | Product Datasheet V0.9 Released |
| V1.0 | Jun. 2022 | Update Typical Characteristics |
| V1.1 | Sep.2022 | Modified trigger mode of Strobe/Torch pin |

awinic Confidential

Disclaimer

Information in this document is believed to be accurate and reliable. However, Shanghai AWINIC Technology Co., Ltd (AWINIC Technology) does not give any representations or warranties, expressed or implied, as to the accuracy or completeness of such information and shall have no liability for the consequences of use of such information.

AWINIC Technology reserves the right to make changes to information published in this document, including without limitation specifications and product descriptions, at any time and without notice. Customers shall obtain the latest relevant information before placing orders and shall verify that such information is current and complete. This document supersedes and replaces all information supplied prior to the publication hereof.

AWINIC Technology products are not designed, authorized or warranted to be suitable for use in medical, military, aircraft, space or life support equipment, nor in applications where failure or malfunction of an AWINIC Technology product can reasonably be expected to result in personal injury, death or severe property or environmental damage. AWINIC Technology accepts no liability for inclusion and/or use of AWINIC Technology products in such equipment or applications and therefore such inclusion and/or use is at the customer's own risk.

Applications that are described herein for any of these products are for illustrative purposes only. AWINIC Technology makes no representation or warranty that such applications will be suitable for the specified use without further testing or modification.

All products are sold subject to the general terms and conditions of commercial sale supplied at the time of order acknowledgement.

Nothing in this document may be interpreted or construed as an offer to sell products that is open for acceptance or the grant, conveyance or implication of any license under any copyrights, patents or other industrial or intellectual property rights.

Reproduction of AWINIC information in AWINIC data books or data sheets is permissible only if reproduction is without alteration and is accompanied by all associated warranties, conditions, limitations, and notices. AWINIC is not responsible or liable for such altered documentation. Information of third parties may be subject to additional restrictions.

Resale of AWINIC components or services with statements different from or beyond the parameters stated by AWINIC for that component or service voids all express and any implied warranties for the associated AWINIC component or service and is an unfair and deceptive business practice. AWINIC is not responsible or liable for any such statements.