

VIPAC™ Family of Power Systems 50 to 900 Watt

Description & Installation Guide



Product Description

Vicor's VIPAC is a new type of integrated power system leveraging the latest advances in DC-DC converter technology and modular front-ends. VIPAC combines application specific power processing units (PPU), a choice of chassis styles and remotely located hold-up capacitors to provide fast, flexible and highly reliable power solutions for a wide range of demanding applications.

The PPU is the core element of the system and may be specified for 115/230 Vac operation. The PPU incorporates Vicor's autoranging FARM modular front-end to provide transient protection, EMI filtering and inrush current limiting. The web-based **PowerBench™** enables designers to configure the PPU with up to three independently regulated outputs having power levels from 50 to 500 W and with as much as 900 W total output power.

(continued)



Product Description cont.

Vicor's Maxi, Mini, Micro Family DC-DC converters, in industry standard quarter, half and full brick packages, are used to deliver output voltages from 2 to 48 Vdc. Additionally, the wide trim range of the modules can provide operating voltages as low as 500 mV.

The PPU is comprised of:

- AC input modular front-end
- Vicor's Maxi, Mini, Micro Family, high density DC-DC converters
- Coldplate or finned chassis
- User interface
- Choice of output termination styles

The *VIPAC* is offered in several chassis configurations facilitating its use in a variety of applications using either conduction, convection or forced convection cooling. The low profile, conduction cooled version may be mounted to an existing cabinet wall, coldplate or heat sink. The 0.5" or 1" finned versions, available in longitudinal or transverse configurations, are ideal for use in free or forced convection environments.

VIPACs use remotely located capacitors to facilitate packaging and placement options not previously available. The low profile PPU can be placed closer to the load or attached to cabinet walls while the capacitors may be integrated into the host system away from heat sources for improved reliability. System hold-up / ride-thru requirements can also be tailored for specific applications via different value capacitors. The hold-up capacitors may be obtained from Vicor as a prepackaged hold-up box (HUB). *VIPAC* is a new class of flexible, high density power solutions.



PPU

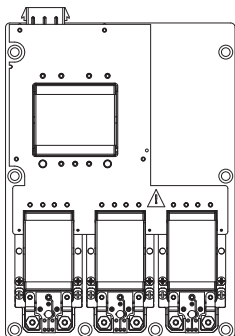

HUB



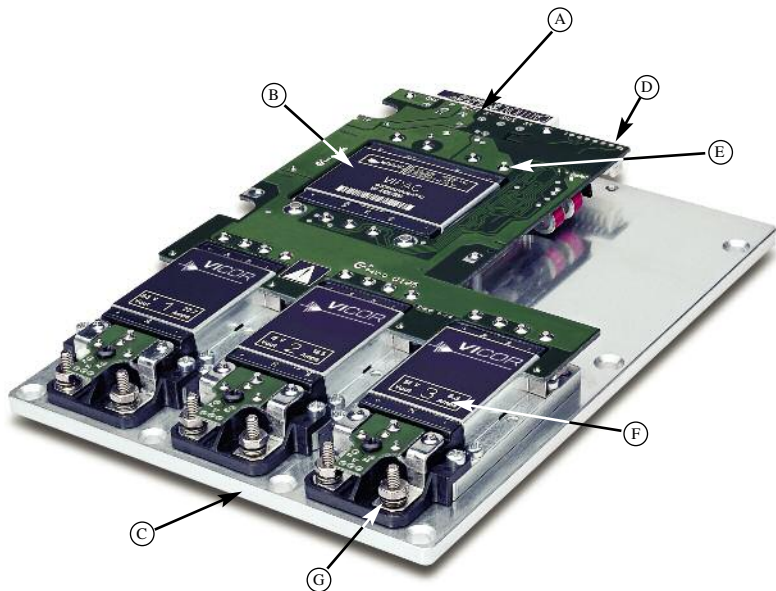

(A) Input
115/230 Vac Autoranging

(B) Pre-assembled and Tested Front-ends
FARM – Filter Autoranging Rectifier Module

(C) Platform Options
Low Profile Coldplate
0.5" and 1" Optional
Finned Configurations

(D) I/O Interface
Output Sequencing
BUS-OK

(E) Protective Features
Auto Restart
Inrush Current Limiting
EMI Filtering
Input Transient Protection

(F) Vicor's Maxi, Mini, Micro DC-DC Converters
Output Voltages 0.5 – 48 Vdc
50 – 500 W / Output
(1/4 Brick Modules Shown)

(G) Choice of Output Termination
LugMate (shown)
PlugMate

Overview

The front-end section utilizes Vicor's FARM input module to provide EMI filtering, transient protection, inrush current limiting and rectification. The front-end also contains input connectors, fusing and control circuitry to which the user can interface with discrete circuitry. Up to three individually fused Vicor Maxi, Mini, Micro DC-DC converter modules are combined with the front-end in an integrated mechanical assembly providing a high efficiency power supply delivering up to 900 W of output power.

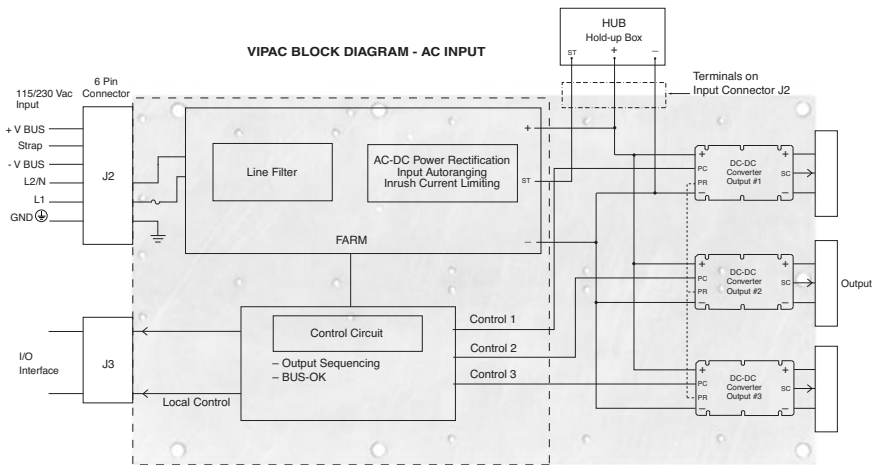

Application Tips

Remote Sense

A remote sense feature is provided on outputs configured with Mini or Maxi sized DC-DC converters. The output sense connections **must** be terminated either locally or remotely and may not be left open. VIPACs provided with the optional LugMate connectors are configured for local sensing via removable jumpers installed at the factory. The jumpers will need to be removed if access to the secondary control function is made via mating connector 16385 and connections will need to be established for local or remote sensing.

Hold-up Capacitors

Hold-up capacitors can be located remotely with up to 3' of cable. Vicor applications engineering should be consulted for projects requiring greater separation.

Wire Routing

Avoid routing wires over the VIPAC Power System.

Do not bundle Input and Output leads together.

Crimping Tool

Amp Hand Tool P/N	Die Set #	Wire Size
91508-1		20-18 AWG
91506-1		16-14 AWG
69710-1	58380-1	12 AWG
	58380-2	10 AWG

Parallel Outputs

The VIPAC can be configured with parallel modules for increased power or redundancy. When output terminations other than the LugMate are specified the user must properly connect the output and sense terminals. At no time operate a paralleled output with a load applied to only one module! (See Output Connection Options)

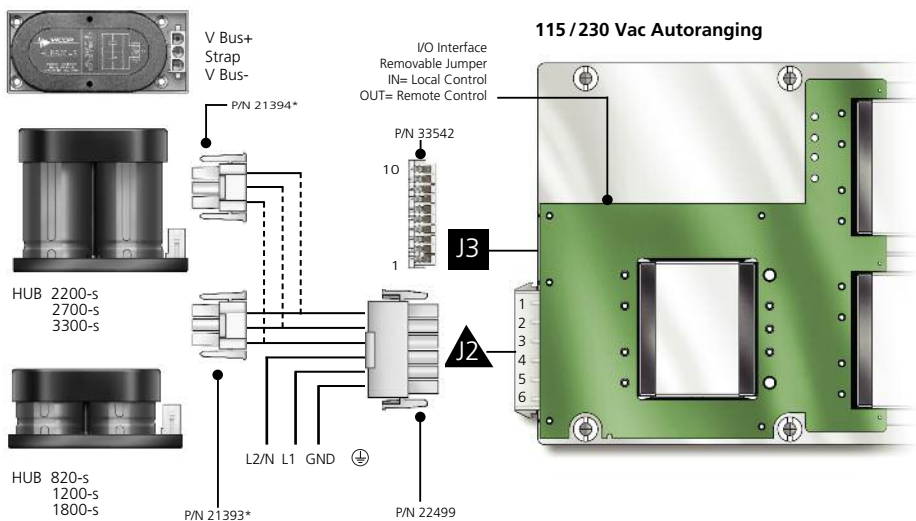

Maximum cable length between the HUB and VIPAC $\leq 3'$

*In the event of interference when connecting to the HUB, please remove the unused strain relief tab on the connector.



AC Input/V Bus

Conn.	Pin#	Funct.	Mating Conn.
J2	1	V Bus+	P/N 22499
	2	Strap	
	3	V Bus-	
	4	L2/N	
	5	L1	
	6	GND ⊕	



I/O Interface

Conn.	Pin#	Funct.	Mating
J3	1	Module 1 E/D Return	P/N 33542
	2	Module 1 E/D Supply	
	3	Module 2 E/D Return	
	4	Module 2 E/D Supply	
	5	Module 3 E/D Return	
	6	Module 3 E/D Supply	
	7	BUS-OK Status Return	
	8	BUS-OK Status Supply	
	9	N/C	
	10	BUS-OK Drive Input	

Output Connection Options

Discrete Output Configurations

LugMate (Factory Installed Option)

Ring Lugs

Micro LugMate

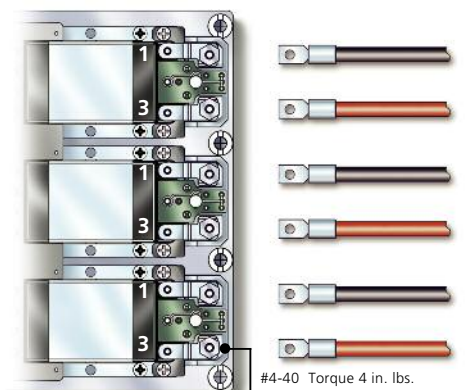

LugMate Pin Out

Pin #	Solder Pad	Function
1	Rd	- Vout
	SC	Trim Down
	Ru	Trim Up
3		+ Vout

Micro LugMate - with Rd/Ru trim resistor solder pads. (Design calculator for trim resistors located at vicorpower.com)

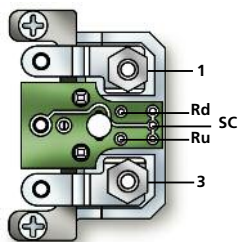

Mini/Maxi LugMate

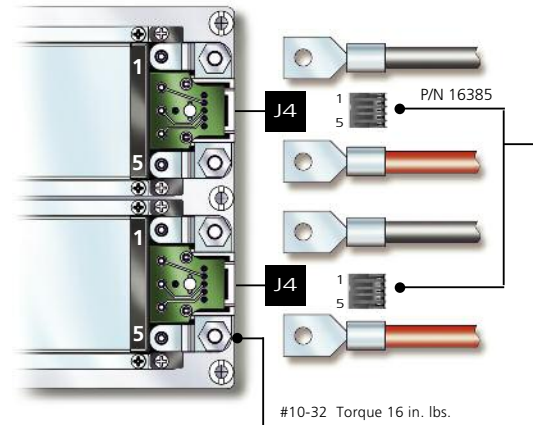

Pin #	Conn.	Function	Mating Conn.
1		- Vout	
J4-1		- Vout	P/N 16385
J4-2		- Sense	
J4-3		Secondary Control	
J4-4		+ Sense	
J4-5		+ Vout	
5		+ Vout	

*Removable jumper is factory installed for local sensing. See Pg 5 for details

Output Connection Options

Parallel Output Configurations

Shown with the output of two modules connected in parallel using BUS BARS.

LugMate (Factory Installed Option)

Ring Lugs

Micro LugMate

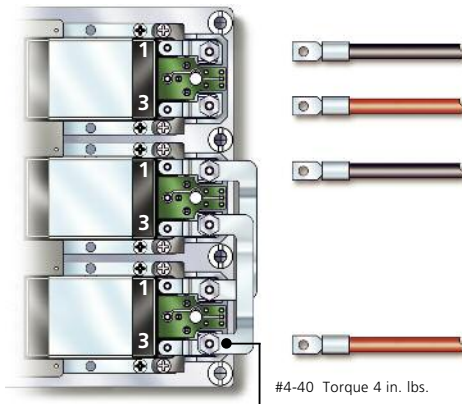

LugMate Pin Out

Pin #	Solder Pad	Function
1	Rd	- Vout
	SC	Trim Down
	Ru	Trim Up
3		+ Vout

Micro LugMate - with Rd/Ru trim resistor solder pads. (Design calculator for trim resistors located at vicorpower.com)

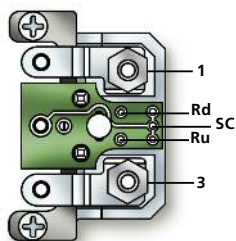

Mini/Maxi LugMate

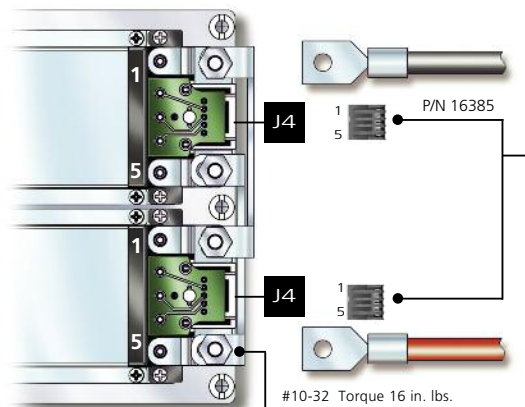

Pin #	Conn.	Function	Mating Conn.
1		- Vout	
	J4-1	- Vout	P/N 16385
	J4-2	- Sense	
	J4-3	Secondary Control	
	J4-4	+ Sense	
	J4-5	+ Vout	
5		+ Vout	

*Removable jumper is factory installed for local sensing. See Pg 5 for details

Output Connection Options

Please Note:

VIPACs that contain multiple modules configured as a single output (paralleled for power or redundancy) **MUST** have their Outputs and Sense connected to each other at the load. **DO NOT OPERATE A PARALLEL CONFIGURATION WITH ONLY ONE MODULE CONNECTED.**

PlugMate

(Factory Installed Option)

Micro PlugMate

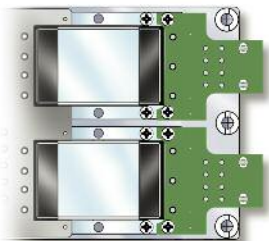

Vicor P/N 25073

1	4
5	8

Pin #	Function	Pin #	Function
1	+Vout	5	+Vout
2	+Vout	6	N/C
3	-Vout	7	SC
4	-Vout	8	-Vout

Mating Conn.	Amp. P/N	Vicor P/N
Housing	TYC-794657-8	25056
Pin	1-106529-2	24796
Kit		25073

Mini PlugMate

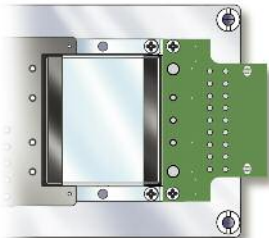

Vicor P/N 25067

1	9
10	18

Pin #	Function	Pin #	Function
1	+Vout	10	+Vout
2	+Vout	11	+Vout
3	+Vout	12	+Vout
4	N/C	13	+S
5	N/C	14	SC
6	N/C	15	-S
7	-Vout	16	-Vout
8	-Vout	17	-Vout
9	-Vout	18	-Vout

Mating Conn.	Amp. P/N	Vicor P/N
Housing	TYC1-794657-8	25050
Pin	1-106529-2	24796
Kit		25067

Maxi PlugMate

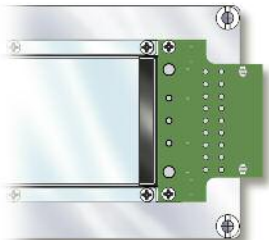

Vicor P/N 25061

1	12
13	24

Pin #	Function	Pin #	Function
1	+Vout	13	+Vout
2	+Vout	14	+Vout
3	+Vout	15	+Vout
4	+Vout	16	+Vout
5	+Vout	17	+Vout
6	N/C	18	+S
7	SC	19	-S
8	-Vout	20	-Vout
9	-Vout	21	-Vout
10	-Vout	22	-Vout
11	-Vout	23	-Vout
12	-Vout	24	-Vout

Mating Conn.	Amp. P/N	Vicor P/N
Housing	TYC2-794657-4	25044
Pin	1-106529-2	24796
Kit		25061

Input Mating Connector Kits

Part Number	Description
23485R	<p>For use with: 115/230 Vac Autoranging Input VIPAC using HUB 820-S, 1200-S or 1800-S</p> <p>Kit Contains: One 3 pin HUB mating connector, Vicor P/N 21393 One 6 pin AC Input mating connector, Vicor P/N 22499 One 7 pin I/O Interface mating connector, Vicor P/N 22988 One 10 pin I/O Interface mating connector, Vicor P/N 33542</p>
23486R	<p>For use with: 115/230 Vac Autoranging Input VIPAC using HUB 2200-S, 2700-S or 3300-S</p> <p>Kit Contains: One 3 pin HUB mating connector, Vicor P/N 21394 One 6 pin AC Input mating connector, Vicor P/N 22499 One 7 pin I/O Interface mating connector, Vicor P/N 22988 One 10 pin I/O Interface mating connector, Vicor P/N 33542</p>

Output Mating Connector Kits

Part Number	Description
23488R	<p>For use with: Mini or Maxi LugMate</p> <p>Kit Contains: One control connector, Vicor P/N 16385; Two ring lugs</p>
23489	<p>For use with: Micro LugMate</p> <p>Kit Contains: Two ring lugs</p>
25061	<p>For use with: Maxi PlugMate</p> <p>Kit Contains: One 24 pin housing, Vicor P/N 25044; 24 pins, Vicor P/N 24796</p>
25067	<p>For use with: Mini PlugMate</p> <p>Kit Contains: One 18 pin housing, Vicor P/N 25050; 18 pins, Vicor P/N 24796</p>
25073	<p>For use with: Micro PlugMate</p> <p>Kit Contains: One 8 pin housing, Vicor P/N 25056; 8 pins, Vicor P/N 24796</p>



General Information

Mating Connector Cross Reference

Designator	Description	Vicor P/N Pin & Housing	Manufacturer	P/N Pin	P/N Housing
J2	VIPAC Input - 6 Pin	22499	AMP	350551-1	640585-1
J3	VIPAC I/O Interface - 10 Pin	33542	JST	10ZR-3H or 10ZR-8M	
J4	VIPAC Output Control - 5 Pin	16385	AMP	MTA100-IDC644083-5	
	HUB 820-S, 1200-S, 1800-S 3 Pin	21393	AMP	770248-1	770018-1
	HUB 2200-S, 2700-S, 3300-S 3 Pin	21394	AMP	193842-1	770018-1
	Micro PlugMate mating conn. – 8 Pin	25073	AMP	1-106529-2	TYC-794657-8
	Mini PlugMate mating conn. – 18 Pin	25067	AMP	1-106529-2	TYC1-794657-8
	Maxi PlugMate mating conn. – 24 Pin	25061	AMP	1-106529-2	TYC2-794657-4

Suggested Wire Gauge

Function	Wire Gauge	Application
AC Input Leads	#14	All AC and earth GND ⊕ leads (VIPAC power systems)
DC Output Leads	#20	0 A – 3 A
	#18	4 A – 6 A
	#16	7 A – 10 A
	#14	11 A – 15 A
	#12	16 A – 25 A
	#10	26 A – 40 A
	#8	41 A – 65 A
	#6	66 A – 104 A
	#4	105 A – 160 A

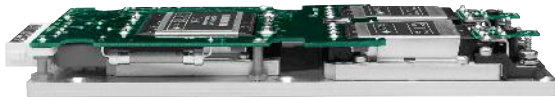

*Information furnished by Vicor is believed to be accurate and reliable. However, no responsibility is assumed by Vicor for its use. No license is granted by implication or otherwise under any patent or patent rights of Vicor. Vicor components are not designed to be used in applications, such as life support systems, wherein a failure or malfunction could result in injury or death. All sales are subject to Vicor's Terms and Conditions of Sale, which are available upon request. No user serviceable components, contact Vicor to arrange for repair or replacement. **Specifications are subject to change without notice.***

Visit the Vicor website at:

vicorpower.com