

BMP80N180C1

Super Junction Power MOSFET

800 V, 23 A, 180 mΩ



Description

BMP80N180C1 is power MOSFET using bestirpower's advanced super junction technology that can realize very low on resistance and gate charge. It will provide much high efficiency by using optimized charge coupling technology. These user friendly devices give an advantage of Low EMI to designers as well as low switching loss.

Applications

- PC power.
- Server power supply.
- Telecom.
- LED lighting.
- EV Charger.
- Solar/UPS.

Features

$BV_{DSS} @ T_{J,max}$	I_D	$R_{DS(on),max}$	$Q_{g,typ}$
850 V	23 A	180 mΩ	56 nC

- Ultra-fast body diode.
- Extremely low losses due to very low FOM $R_{dson} * Q_g$ and E_{oss} .
- Very high commutation ruggedness.

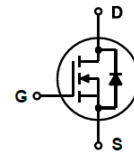
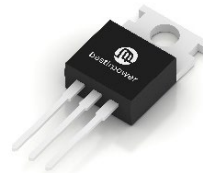

Absolute Maximum Ratings ($T_J = 25^\circ\text{C}$ unless otherwise noted)

Symbol	Parameter	Value	Unit
V_{DSS}	Drain to Source Voltage(1)	800	V
V_{GSS}	Gate to Source Voltage	± 30	V
I_D	Drain Current(2)	$V_{GS} = 10 \text{ V}, (T_C = 25^\circ\text{C})$	23
		$V_{GS} = 10 \text{ V}, (T_C = 100^\circ\text{C})$	15
I_{DM}	Drain Current	Pulsed	70
E_{AS}	Single Pulsed Avalanche Energy(3)	845	mJ
I_{AR}	Avalanche Current	13	A
dv/dt	MOSFET dv/dt	50	V/ns
	Peak Diode Recovery dv/dt(4)_	50	
P_D	Power Dissipation	($T_C = 25^\circ\text{C}$)	250
T_J, T_{STG}	Operating and Storage Temperature Range	-55 to 150	$^\circ\text{C}$
I_S	Continuous diode forward current	23	A
$I_{S,pulse}$	Diode pulse current(2)	70	A
T_L	Maximum Lead Temperature for Soldering, 1/8" from Case for 10 Seconds	260	$^\circ\text{C}$

1) Limited by T_J max. Maximum duty cycle $D=0.75$.

2) Pulse width t_p limited by $T_{J,max}$.

3) $V_{DD}=50\text{V}$, $R_G=25\Omega$, Starting $T_J=25^\circ\text{C}$.

4) $V_{DCLink}=400\text{V}$; $V_{DS,peak} < V(BR)_{DSS}$; identical low side and high side switch with identical R_G .

Thermal Characteristics

Symbol	Parameter	Value	Unit
$R_{\theta JC}$	Thermal Resistance, Junction to Case, Max.	0.5	$^\circ\text{C/W}$
$R_{\theta JA}$	Thermal Resistance, Junction to Ambient, Max.	62	

Electrical Characteristics (T_J = 25°C unless otherwise noted)

Symbol	Parameter	Test Conditions	Min	Typ	Max	Unit
--------	-----------	-----------------	-----	-----	-----	------

Off Characteristics

BV _{DSS}	Drain to Source Breakdown Voltage	V _{GS} = 0 V, I _D = 250μA	800			V
I _{DSS}	Zero Gate Voltage Drain Current	V _{DS} = 800 V, V _{GS} = 0 V			10	μA
I _{GSS}	Gate-Source Leakage Current	V _{GS} = ±30 V, V _{DS} = 0 V			±100	nA

On Characteristics

V _{GS(th)}	Gate Threshold Voltage	V _{GS} = V _{DS} , I _D = 250μA	2.5	3.5	4.5	V
R _{DS(on)}	Static Drain to Source On Resistance	V _{GS} = 10 V, I _D = 12 A T _J = 25°C		150	180	mΩ

Dynamic Characteristics

C _{iss}	Input Capacitance	V _{DS} = 100 V, V _{GS} = 0 V, f = 250 kHz		2440		pF
C _{oss}	Output Capacitance			83		pF
C _{rss}	Reverse transfer capacitance			1.9		pF
C _{o(tr)}	Time Related Output Capacitance(2)	V _{DS} = 0 to 500 V, V _{GS} = 0 V		214		pF
C _{o(er)}	Energy Related Output Capacitance			66		pF
Q _{g(tot)}	Total Gate Charge at 10 V	V _{DS} = 640 V, I _D = 24 A, V _{GS} = 0 to 10 V		56		nC
Q _{gs}	Gate Charge total			15		nC
Q _{gd}	Gate to Drain "Miller" Charge			21		nC
V _{plateau}	Gate plateau voltage			5.5		V
R _G	Gate Resistance	f = 1 MHz, open drain		4		Ω

Switching Characteristics

t _{d(on)}	Turn-On Delay Time	V _{DS} = 400 V, I _D = 12 A, V _{GS} = 10 V		20		ns
t _r	Turn-On Rise Time			13		ns
t _{d(off)}	Turn-Off Delay Time			117		ns
t _f	Turn-Off Fall Time			12		ns

Source-Drain Diode Characteristics

I _{rrm}	Peak reverse recovery current			29		A
V _{SD}	Diode Forward Voltage	V _{GS} = 0 V, I _F = 12A T _J = 25°C		0.8		V
t _{rr}	Reverse Recovery Time	V _R = 60 V, I _F = 24 A, di _F /dt = 100 A/μs		375		ns
Q _{rr}	Reverse Recovery Charge			6.7		μC

※Notes:

1. Repetitive rating: pulse-width limited by maximum junction temperature.
2. I_{AS} = 4 A, R_G = 25 Ω starting T_J = 25°C .
3. I_{SD} ≤ 8.5 A, di/dt ≤ 100 A/μs, V_{DD} ≤ 400 V, starting T_J = 25°C .

Typical Performance Characteristics

Figure 1: Power dissipation (Non FullPAK)

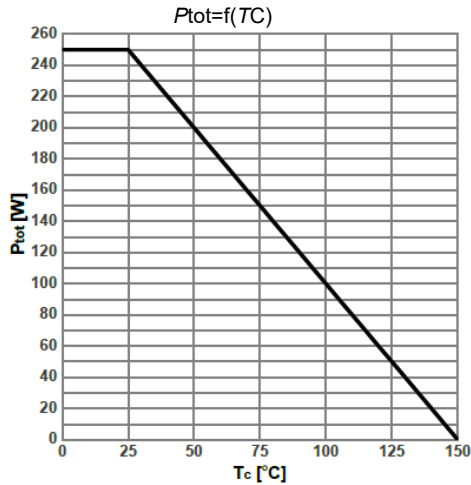

Figure 2: Max. transient thermal impedance

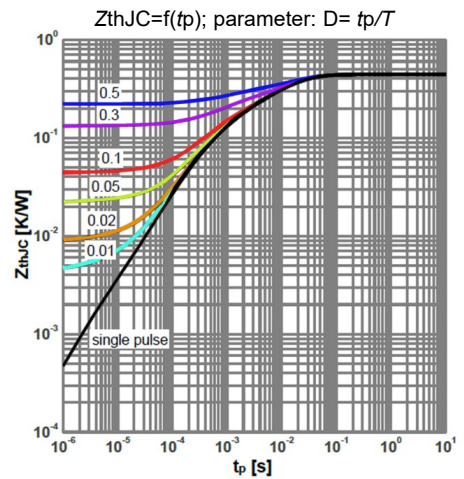

Figure 3: Safe operating area

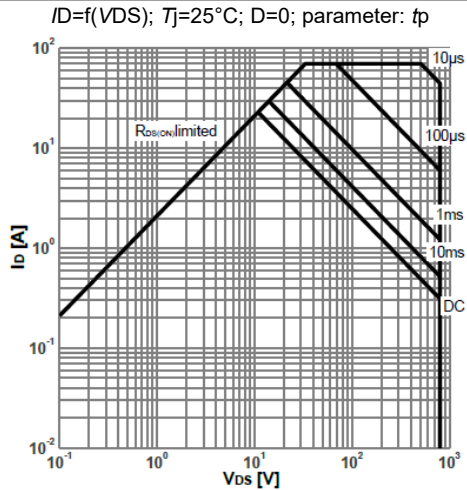

Figure 4: Typ. output characteristics

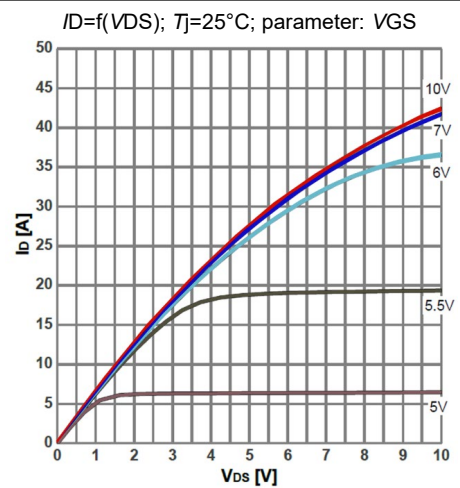

Figure 5: Typ. output characteristics

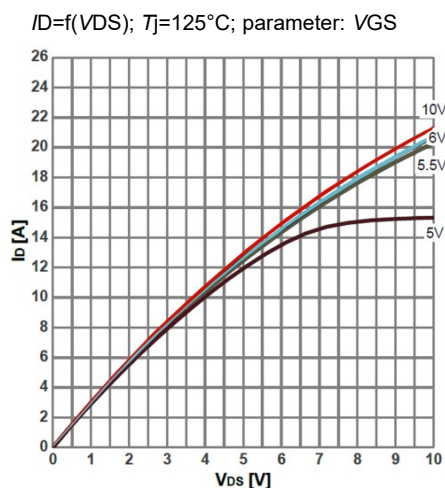
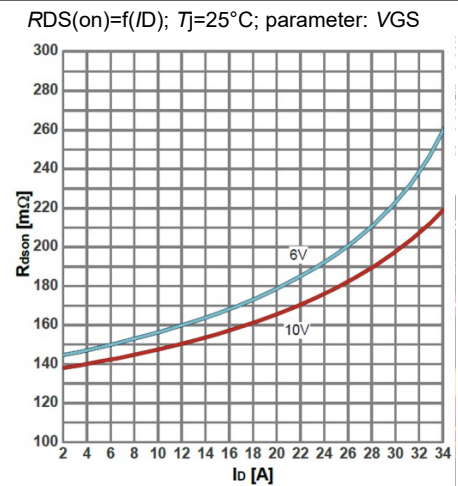

Figure 6: Typ. drain-source on-state resistance



Typical Performance Characteristics

Figure 7: Drain-source on-state resistance

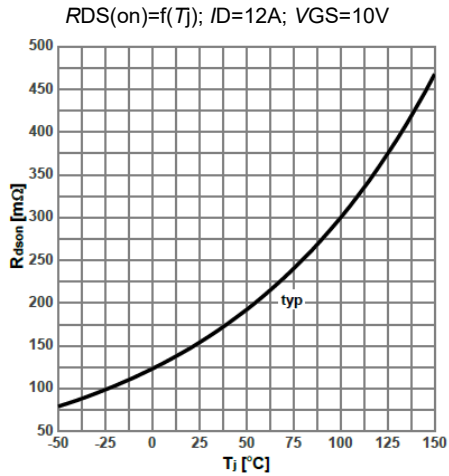

Figure 8: Typ. transfer characteristics

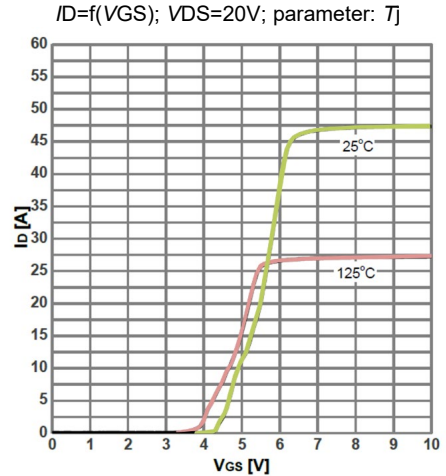

Figure 9: Typ. gate charge

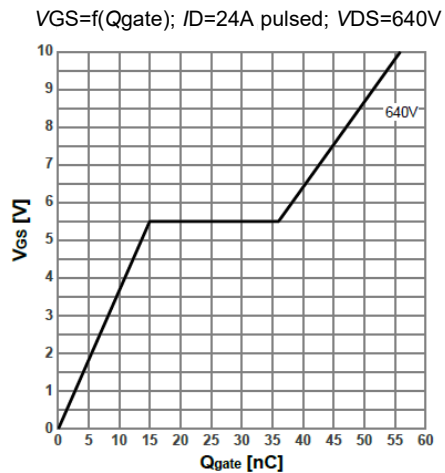

Figure 10: Forward characteristics of reverse diode

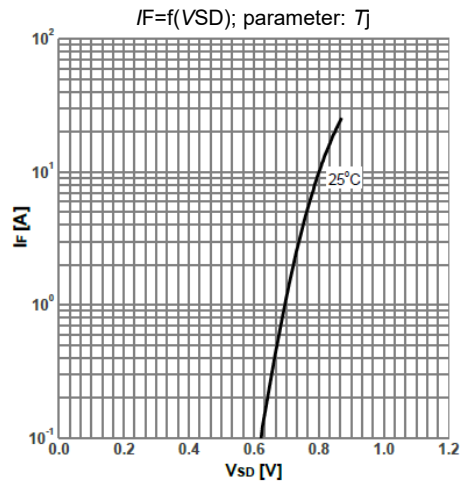

Figure 11: Drain-source breakdown voltage

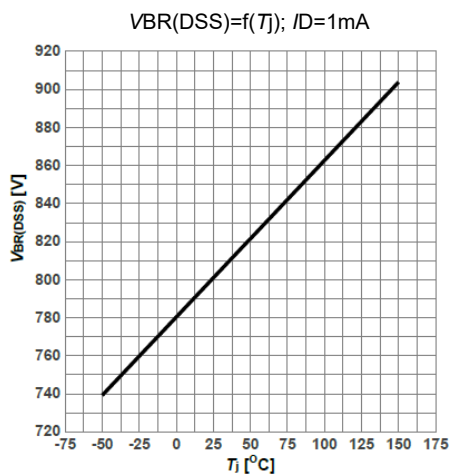
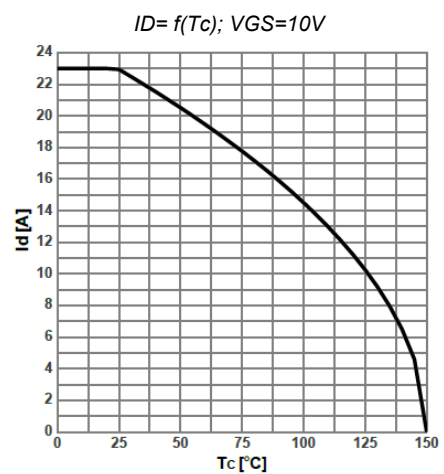

Figure 12: Maximum Drain Current



Typical Performance Characteristics

Figure 13: Typ. capacitances

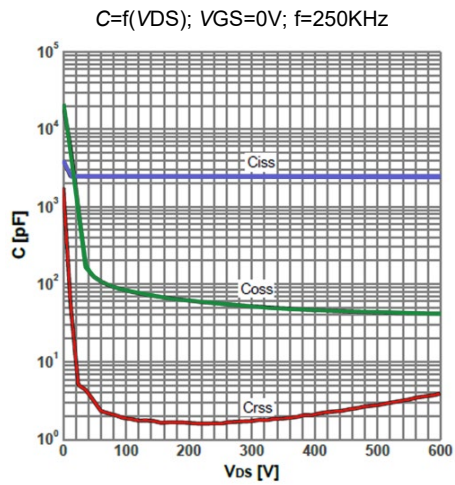
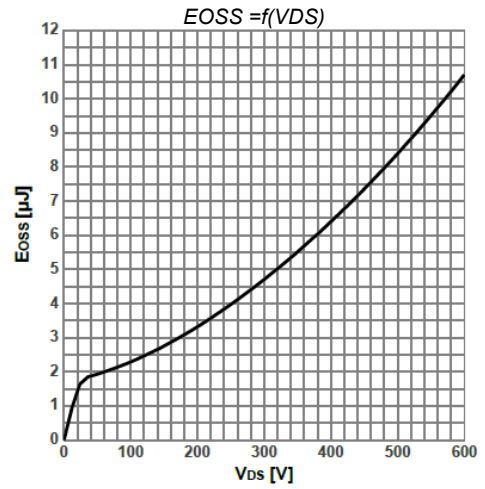

Figure 14: Typ. Coss stored energy



Test Circuits

Figure 15. Diode Characteristics

Test circuit for diode characteristics and Diode recovery waveform

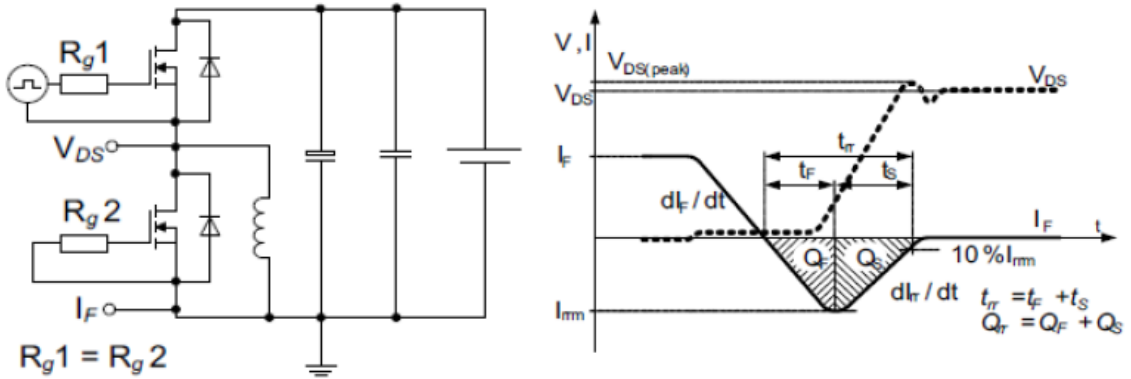

Figure 16. Switching Times

Switching times test circuit for inductive load and Switching times waveform

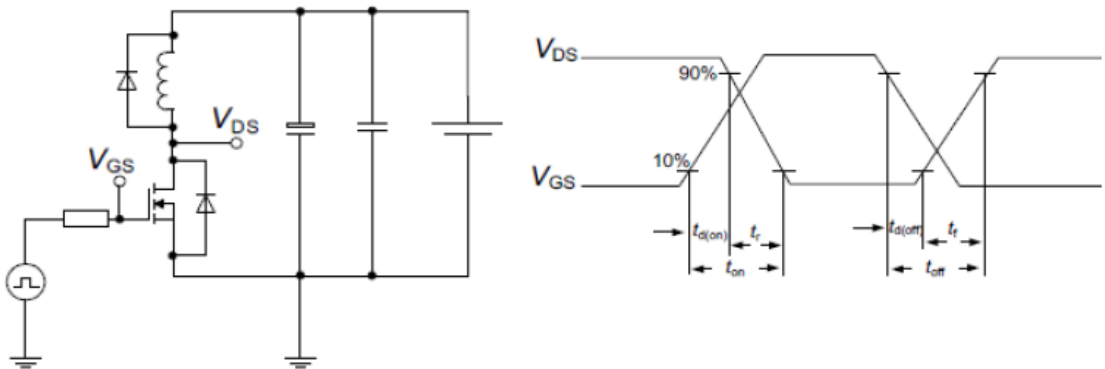
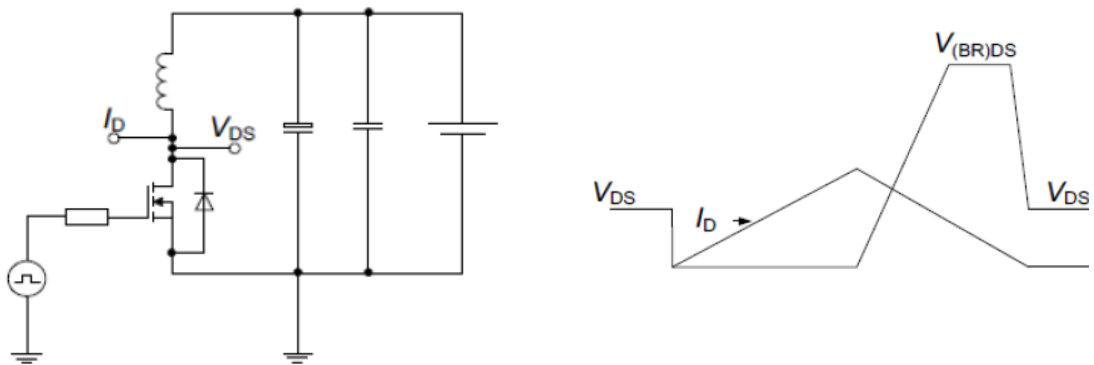

Figure 17. Unclamped Inductive Load

Unclamped inductive load test circuit and Unclamped inductive waveform



Package Outlines

TO220-3L

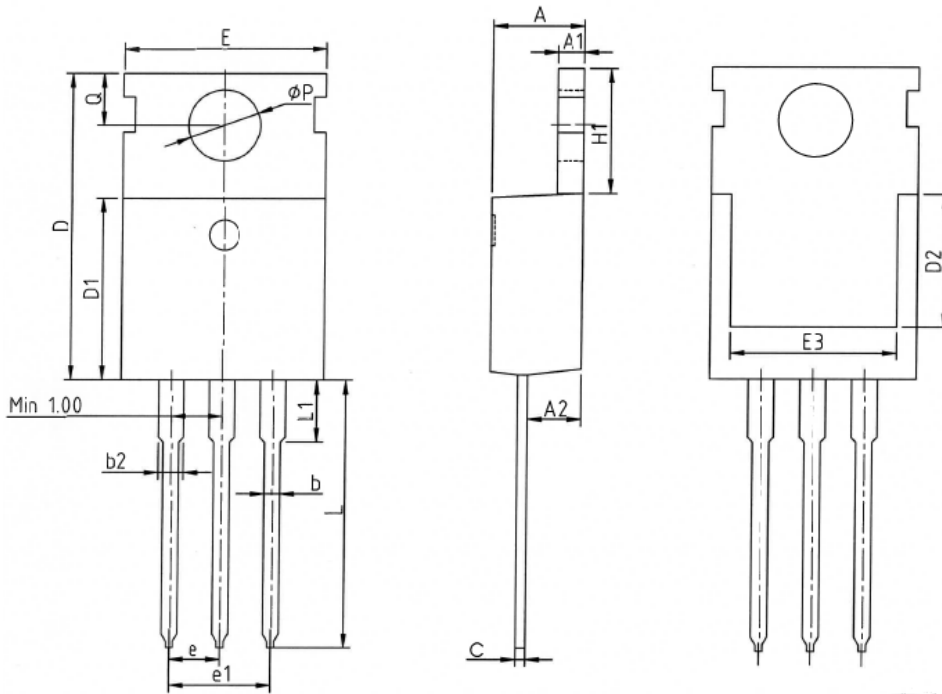

SYMBOL	MIN	NOM	MAX
A	4.37	4.57	4.70
A1	1.25	1.30	1.40
A2	2.20	2.40	2.60
b	0.70	0.80	0.95
b2	1.17	1.27	1.47
c	0.45	0.50	0.60
D	15.10	15.60	16.10
D1	8.80	9.10	9.40
D2	5.50	6.30	7.10
E	9.70	10.00	10.30
E3	7.00	7.80	8.60
e	2.54		BSC
e1	5.08		BSC
H1	6.25	6.50	6.85
L	12.75	13.50	13.80
L1	-	3.10	3.40
ΦP	3.40	3.60	3.80
Q	2.60	2.80	3.00

* Dimensions in millimeters

Package Marking and Ordering Information

Part Number	Top Marking	Package	Packing Method	Quantity
BMP80N180C1	BMP80N180C1	TO220-3L	Tube	50 units

Disclaimer

Bestirpower reserve the right to make changes, corrections, enhancements, modifications, and improvements to Bestirpower products and/or to this document at any time without notice.

The information given in this document shall in no event be regarded as a guarantee of conditions or characteristics. Bestirpower does not assume any liability for infringement of patents, copyrights, or other intellectual property rights of third parties by or arising from the use of Products or technical information described in this document.

This document is the property of Bestirpower Co., LTD., and not allowed to copy or transformed to other format if not under the authority approval.

© 2023 Bestirpower – All rights Reserved