

1SNK900601R0000 ✓ ACTIVE

ENTRELEC | ENTRELEC SNK

TE Internal #: 1SNK900601R0000

Shield Connector, -55 – 110 °C [-67 – 230 °F], ENTRELEC SNK,
Terminal Block & Strip Conducting Accessories

[View on TE.com >](#)



Connectors > Terminal Blocks & Strips > Terminal Block & Strip Accessories > Terminal Block & Strip Conducting Accessories



Conducting Accessory Type: **Shield Connector**

Operating Temperature Range: -55 – 110 °C [-67 – 230 °F]

Features

Product Type Features

Conducting Accessory Type	Shield Connector
---------------------------	------------------

Electrical Characteristics

Voltage Rating (IEC)	100 V
----------------------	-------

Body Features

Product Weight	4.1 g [.145 oz]
----------------	-----------------

Dimensions

Product Depth	11.53 mm [.454 in]
Product Width	2.44 mm [.112 in]
Product Height	116 mm [4.567 in]

Usage Conditions

Installation Temperature Range	-5 – 40 °C [23 – 104 °F]
Operating Temperature Range	-55 – 110 °C [-67 – 230 °F]

Industry Standards

IP Rating	IP20
-----------	------

Product Compliance

[For compliance documentation, visit the product page on TE.com>](#)





EU RoHS Directive 2011/65/EU	Compliant
EU ELV Directive 2000/53/EC	Compliant
China RoHS 2 Directive MIIT Order No 32, 2016	No Restricted Materials Above Threshold
EU REACH Regulation (EC) No. 1907/2006	Current ECHA Candidate List: JUNE 2024 (241) Candidate List Declared Against: JUNE 2024 (241) Does not contain REACH SVHC
Halogen Content	Low Halogen - Br, Cl, F, I < 900 ppm per homogenous material. Also BFR/CFR/PVC Free
Solder Process Capability	Not reviewed for solder process capability

Product Compliance Disclaimer

This information is provided based on reasonable inquiry of our suppliers and represents our current actual knowledge based on the information they provided. This information is subject to change. The part numbers that TE has identified as EU RoHS compliant have a maximum concentration of 0.1% by weight in homogenous materials for lead, hexavalent chromium, mercury, PBB, PBDE, DBP, BBP, DEHP, DIBP, and 0.01% for cadmium, or qualify for an exemption to these limits as defined in the Annexes of Directive 2011/65/EU (RoHS2). Finished electrical and electronic equipment products will be CE marked as required by Directive 2011/65/EU. Components may not be CE marked. Additionally, the part numbers that TE has identified as EU ELV compliant have a maximum concentration of 0.1% by weight in homogenous materials for lead, hexavalent chromium, and mercury, and 0.01% for cadmium, or qualify for an exemption to these limits as defined in the Annexes of Directive 2000/53/EC (ELV). Regarding the REACH Regulation, the information TE provides on SVHC in articles for this part number is based on the latest European Chemicals Agency (ECHA) 'Guidance on requirements for substances in articles' posted at this URL: <https://echa.europa.eu/guidance-documents/guidance-on-reach>

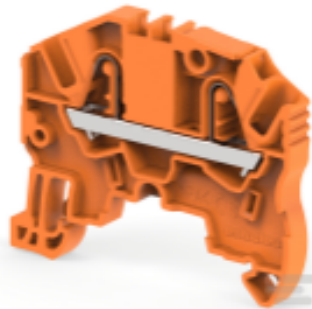
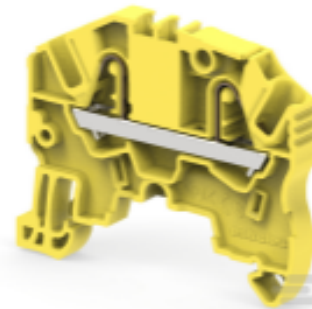
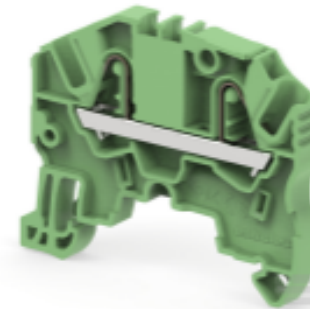
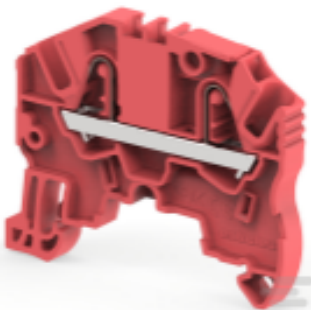
Compatible Parts

 <p>TE Part # 1SNK705020R0000 ZK2.5-BL</p>	 <p>TE Part # 1SNK705030R0000 ZK2.5-OR</p>	 <p>TE Part # 1SNK705060R0000 ZK2.5-YL</p>	 <p>TE Part # 1SNK705061R0000 ZK2.5-GN</p>
 <p>TE Part # 1SNK705062R0000 ZK2.5-RD</p>	 <p>TE Part # 1SNK705065R0000 ZK2.5-WH</p>	 <p>TE Part # 1SNK705066R0000 ZK2.5-BK</p>	 <p>TE Part # 1SNK705010R0000 ZK2.5</p>



Also in the Series | ENTRELEC SNK

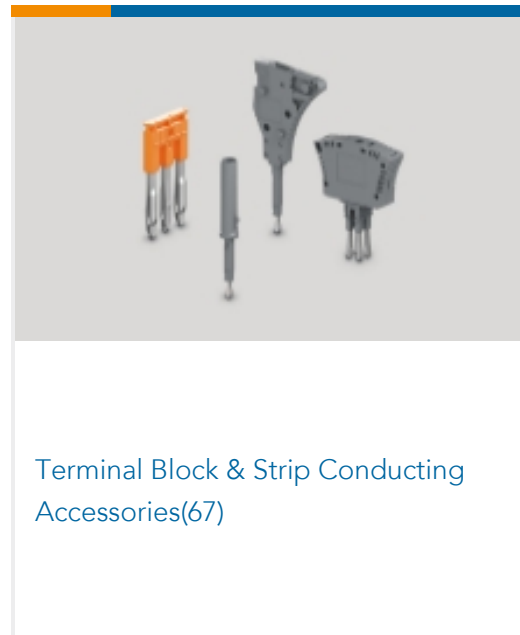

Customers Also Bought

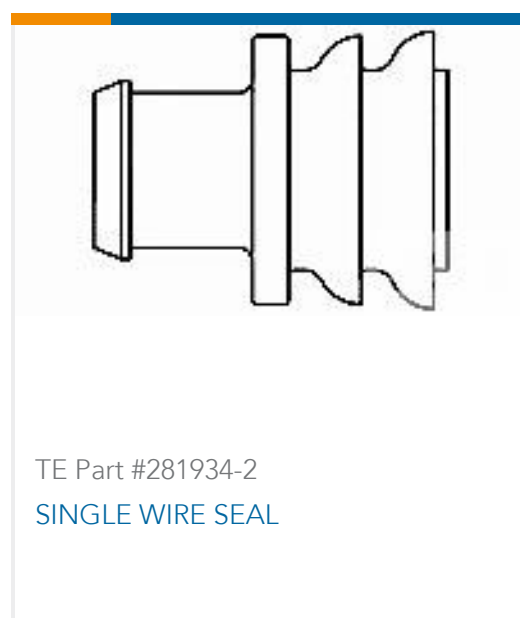

Documents

[CAD Files](#)

[3D PDF](#)

[3D](#)

[Customer View Model](#)

[ENG_CVM_CVM_1SNK900601R0000_A.2d_dxf.zip](#)

English



Customer View Model

[ENG_CVM_CVM_1SNK900601R0000_A.3d_igs.zip](#)

English

Customer View Model

[ENG_CVM_CVM_1SNK900601R0000_A.3d_stp.zip](#)

English

By downloading the CAD file I accept and agree to the [Terms and Conditions](#) of use.

Datasheets & Catalog Pages

[ENTRELEC Terminal Block - Master Catalog](#)

[ENTRELEC Terminal Block - Master Catalog](#)

English

SHBP

English

SNK SERIES TERMINAL BLOCKS

English

[ENTRELEC Terminal Blocks Catalogue \(RUS\)](#)